

This document, which comprises an admission document, required by the rules of Prospects MTF, a market regulated as a multilateral trading facility and operated by the Malta Stock Exchange (the "MSE" or "Exchange"), has been drawn up in compliance with the Prospects MTF Rules issued by the Exchange. This document does not comprise a document drawn up in terms of the EU Prospectus Directive (2003/71/EC) or for the purposes of the Listing Rules of the Listing Authority. In terms of article 2(3)(b)(ii) of the Companies Act, Chapter 386 of the laws of Malta, this Bond Issue does not constitute an offer of securities to the public and this document does not constitute a prospectus as defined in article 2(i) of the said Act.



a public limited liability company incorporated under the laws of Malta.
company registration number C 91544

In respect of an issue of

€6 million 4.75% Secured Callable Bonds 2026- 2029

ISIN: MT0002301209

of a nominal value of €100 per Bond issued at par
(Due 2026-2029, subject to early redemption option by the Issuer on any of the Early Redemption Dates) by
KA FINANCE PLC
A public limited liability company registered in Malta with company registration number C91544

Guaranteed by*
KA Holdings Limited
a private limited liability company registered in Malta
company registration number C56023

*Prospective investors are to refer to the guarantee contained in Annex B of this Company Admission Document for a description of the Guarantee. Reference should also be made to the sections entitled "Risk Factors" contained in this Company Admission Document for a discussion of certain risk factors, which should be considered by prospective investors in connection with the Secured Callable Bonds including but not limited to the guarantee provided by KA Holdings Limited.

COMPANY ADMISSION DOCUMENT

Dated 24th July, 2019

THE MSE HAS AUTHORISED THE ISSUE OF THIS DOCUMENT. THE MSE DOES NOT GIVE ANY CERTIFICATION, REPRESENTATION, WARRANTY OR GUARANTEE REGARDING THE POTENTIAL RISKS INVOLVED IN INVESTING IN THE SAID SECURITIES OR THE SAFETY OF INVESTING IN SUCH SECURITIES. THE MSE ACCEPTS NO RESPONSIBILITY FOR ACCURACY OR COMPLETENESS OF THIS ADMISSION DOCUMENT AND EXPRESSLY DISCLAIMS ANY LIABILITY WHATSOEVER FOR ANY LOSS HOWSOEVER ARISING FROM OR IN RELIANCE UPON THE WHOLE OR ANY PART OF THE CONTENTS OF THIS ADMISSION DOCUMENT. THE DIRECTORS OF THE ISSUER ARE THE PERSONS RESPONSIBLE FOR THE

INFORMATION CONTAINED IN THIS DOCUMENT. TO THE BEST OF THE KNOWLEDGE AND BELIEF OF THE DIRECTORS (WHO HAVE ALL TAKEN REASONABLE CARE TO ENSURE SUCH IS THE CASE), THE INFORMATION CONTAINED IN THIS DOCUMENT IS IN ACCORDANCE WITH FACTS AND DOES NOT OMIT ANYTHING LIKELY TO AFFECT THE IMPORTANCE OF SUCH INFORMATION. THE DIRECTORS ASSUME FULL RESPONSIBILITY FOR ITS CONTENTS ACCORDINGLY.

APPLICATION HAS BEEN MADE FOR THE ADMISSION OF THESE SECURITIES ON PROSPECTS MTF, A MARKET REGULATED AS A MULTILATERAL TRADING FACILITY OPERATED BY THE MALTA STOCK EXCHANGE. THIS MEANS THAT THE SAID INSTRUMENTS ARE IN COMPLIANCE WITH THE ADMISSION REQUIREMENTS SET OUT IN THE PROSPECTS MTF RULES. IN PROVIDING THIS AUTHORISATION, THE MSE DOES NOT GIVE ANY CERTIFICATION REGARDING THE POTENTIAL RISKS IN INVESTING IN THE SAID INSTRUMENTS AND SUCH AUTHORISATION SHOULD NOT BE DEEMED OR CONSTRUED AS A REPRESENTATION OR WARRANTY AS TO THE SAFETY OF INVESTING IN SUCH INSTRUMENTS.

INVESTING IN COMPANIES ADMITTED TO PROSPECTS MTF MAY PUT AN INVESTOR'S CASH PARTLY OR WHOLLY AT RISK. SECURITIES ISSUED BY SMALL AND MEDIUM-SIZED ENTERPRISES TEND TO BE ILLIQUID AND CARRY HIGHER RISKS. INVESTORS SHOULD THUS SEEK APPROPRIATE ADVICE AND READ THE WHOLE DOCUMENT BEFORE MAKING ANY INVESTMENT DECISIONS. THE VALUE OF INVESTMENTS CAN RISE, OR FALL AND PAST PERFORMANCE IS NOT NECESSARILY INDICATIVE OF FUTURE PERFORMANCE. IF YOU NEED ADVICE OR ARE REQUIRED UNDER APPLICABLE LEGISLATION TO SEEK ADVICE WITH RESPECT TO THIS SECURITIES ISSUE, YOU SHOULD CONSULT A DULY LICENSED INVESTMENT ADVISOR.

THE BONDS ARE COMPLEX FINANCIAL INSTRUMENTS AND MAY NOT BE SUITABLE FOR ALL TYPES OF RETAIL INVESTORS. A POTENTIAL INVESTOR SHOULD NOT INVEST IN THE BONDS UNLESS: i) HE/SHE HAS THE NECESSARY KNOWLEDGE AND EXPERIENCE TO UNDERSTAND THE RISKS RELATING TO THIS TYPE OF FINANCIAL INSTRUMENT; ii) THE BONDS MEET THE INVESTMENT OBJECTIVES OF THE POTENTIAL INVESTOR; AND iii) SUCH POTENTIAL INVESTOR IS ABLE TO BEAR THE INVESTMENT AND FINANCIAL RISKS WHICH RESULT FROM INVESTMENT IN THESE BONDS.

Approved by the directors



Kurt Abela



Etienne Borg Cardona

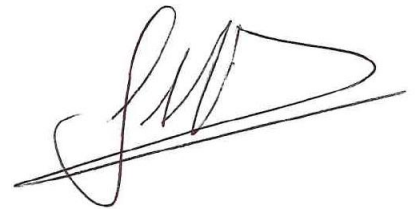

John Soler

IMPORTANT INFORMATION

THIS COMPANY ADMISSION DOCUMENT CONTAINS INFORMATION ON KA FINANCE PLC IN ITS CAPACITY AS ISSUER AND, KA HOLDINGS LIMITED IN ITS CAPACITY AS GUARANTOR, IN ACCORDANCE WITH THE PROSPECTS MTF RULES ISSUED BY THE MALTA STOCK EXCHANGE.

APPLICATION HAS BEEN MADE TO THE EXCHANGE FOR THE SECURED CALLABLE BONDS TO BE ADMITTED TO TRADING ON PROSPECTS MTF. PROSPECTS MTF IS A MARKET REGULATED AS A MULTILATERAL TRADING FACILITY AND OPERATED BY THE MALTA STOCK EXCHANGE DESIGNED PRIMARILY FOR EMERGING AND SMALLER COMPANIES TO WHICH A HIGHER INVESTMENT RISK TENDS TO BE ATTACHED. PROSPECTS MTF SECURITIES ARE NOT ADMITTED TO THE OFFICIAL LIST OF THE MALTA STOCK EXCHANGE.

AUTHORISED FINANCIAL INTERMEDIARIES MUST UNDERTAKE AN APPROPRIATENESS TEST AND, WHEN PROVIDING ADVICE IN RESPECT OF A PURCHASE OF THE BONDS, A SUITABILITY TEST, ON PROSPECTIVE BONDHOLDERS IN ORDER TO BE SATISFIED THAT THE BONDS ARE A SUITABLE INVESTMENT FOR THE RESPECTIVE CLIENT, PRIOR TO EXECUTING A PURCHASE OF THE BONDS.

THE INFORMATION CONTAINED HEREIN IS BEING MADE AVAILABLE IN CONNECTION WITH AN ISSUE BY THE ISSUER OF €6 MILLION SECURED CALLABLE BONDS 2026-2029 OF A NOMINAL VALUE OF €100 EACH. THE BONDS SHALL BE ISSUED AT PAR AND BEAR INTEREST AT THE RATE OF 4.75% PER ANNUM PAYABLE ANNUALLY IN ARREARS ON 9th August OF EACH YEAR UNTIL THE REDEMPTION DATE, WITH THE FIRST INTEREST PAYMENT FALLING DUE ON 9th August, 2020. THE NOMINAL VALUE OF THE BONDS WILL BE REPAYABLE IN FULL AT MATURITY ON 9th August, 2029 ON REDEMPTION DATE UNLESS OTHERWISE PREVIOUSLY REPURCHASED FOR CANCELLATION OR UNLESS OTHERWISE PREVIOUSLY REDEEMED AT THE OPTION OF THE ISSUER ON ANY OF THE EARLY REDEMPTION DATES. THE BOND ISSUE IS GUARANTEED BY KA HOLDINGS LTD.

NO BROKER, DEALER, SALESMAN OR OTHER PERSON HAS BEEN AUTHORISED BY THE ISSUER, THE GUARANTOR OR THEIR RESPECTIVE DIRECTORS TO ISSUE ANY ADVERTISEMENT OR TO GIVE ANY INFORMATION OR TO MAKE ANY REPRESENTATIONS IN CONNECTION WITH THE SALE OF SECURED CALLABLE BONDS OF THE ISSUER OTHER THAN THOSE CONTAINED IN THIS COMPANY ADMISSION DOCUMENT AND OTHER DOCUMENTS REFERRED TO HEREIN, AND IF GIVEN OR MADE, SUCH INFORMATION OR REPRESENTATIONS MUST NOT BE RELIED UPON AS HAVING BEEN AUTHORISED BY THE ISSUER, THE GUARANTOR OR THEIR RESPECTIVE DIRECTORS, OR ADVISORS.

THE MSE ACCEPTS NO RESPONSIBILITY FOR THE COMPLETENESS OR ACCURACY OF THE COMPANY ADMISSION DOCUMENT AND EXPRESSLY DISCLAIMS ANY LIABILITY WHATSOEVER FOR ANY LOSS HOWSOEVER ARISING FROM OR IN RELIANCE UPON THE WHOLE OR ANY PART OF THE CONTENTS OF THIS ADMISSION DOCUMENT.

THE COMPANY ADMISSION DOCUMENT DOES NOT CONSTITUTE, AND MAY NOT BE USED FOR PURPOSES OF, AN OFFER OR INVITATION TO SUBSCRIBE FOR SECURED CALLABLE BONDS ISSUED BY THE ISSUER BY ANY PERSON IN ANY JURISDICTION: (I) IN WHICH SUCH OFFER OR INVITATION IS NOT AUTHORISED; OR (II) IN WHICH THE PERSON MAKING SUCH OFFER OR INVITATION IS NOT QUALIFIED TO DO SO; OR (III) TO ANY PERSON TO WHOM IT IS UNLAWFUL TO MAKE SUCH OFFER OR INVITATION. THE DISTRIBUTION OF THE COMPANY ADMISSION DOCUMENT IN CERTAIN JURISDICTIONS MAY BE RESTRICTED AND, ACCORDINGLY, PERSONS INTO WHOSE POSSESSION IT IS RECEIVED ARE REQUIRED TO INFORM THEMSELVES ABOUT, AND TO OBSERVE, SUCH RESTRICTIONS.

THE COMPANY ADMISSION DOCUMENT AND THE OFFERING, SALE OR DELIVERY OF ANY BONDS MAY NOT BE TAKEN AS AN IMPLICATION: (I) THAT THE INFORMATION CONTAINED IN THE COMPANY ADMISSION DOCUMENT IS ACCURATE AND COMPLETE SUBSEQUENT TO ITS DATE OF ISSUE; OR (II) THAT THERE HAS BEEN NO MATERIAL ADVERSE CHANGE IN THE FINANCIAL POSITION OF THE ISSUER AND/OR THE GUARANTOR SINCE SUCH DATE; OR (III) THAT ANY OTHER INFORMATION SUPPLIED IN CONNECTION WITH THE COMPANY ADMISSION DOCUMENT IS ACCURATE AT ANY TIME SUBSEQUENT TO THE DATE ON WHICH IT IS SUPPLIED OR, IF DIFFERENT, THE DATE INDICATED IN THE DOCUMENT CONTAINING THE SAME.

INVESTING IN COMPANIES ADMITTED TO PROSPECTS MTF MAY PUT AN INVESTOR'S CASH PARTLY OR WHOLLY AT RISK. SECURITIES ISSUED BY SMALL AND MEDIUM-SIZED ENTERPRISES ("SMEs") TEND TO BE ILLIQUID AND CARRY HIGHER RISKS. INVESTORS SHOULD THUS SEEK APPROPRIATE ADVICE AND READ THE WHOLE DOCUMENT BEFORE MAKING ANY

INVESTMENT DECISION. A PROSPECTIVE INVESTOR SHOULD ALWAYS SEEK INDEPENDENT FINANCIAL ADVICE BEFORE DECIDING TO INVEST IN ANY FINANCIAL INSTRUMENT. A PROSPECTIVE INVESTOR SHOULD BE AWARE OF THE POTENTIAL RISKS IN INVESTING IN THE SECURITIES OF AN ISSUER AND SHOULD MAKE THE DECISION TO INVEST ONLY AFTER CAREFUL CONSIDERATION AND CONSULTATION WITH HIS OR HER OWN INDEPENDENT LEGAL ADVISORS, ACCOUNTANTS AND/OR OTHER FINANCIAL ADVISORS AS TO LEGAL, TAX, INVESTMENT OR ANY OTHER RELATED MATTERS CONCERNING THE BONDS AND THE COMPANY ADMISSION DOCUMENT.

IT IS THE RESPONSIBILITY OF ANY PERSON IN POSSESSION OF THIS DOCUMENT AND ANY PERSONS WISHING TO APPLY FOR ANY SECURED CALLABLE BONDS ISSUED BY THE ISSUER TO INFORM THEMSELVES OF, AND TO OBSERVE AND COMPLY WITH, ALL APPLICABLE LAWS AND REGULATIONS OF ANY RELEVANT JURISDICTION. PROSPECTIVE INVESTORS FOR ANY SECURITIES THAT MAY BE ISSUED BY THE COMPANY SHOULD INFORM THEMSELVES AS TO THE LEGAL REQUIREMENTS OF SO APPLYING AND OF ANY APPLICABLE EXCHANGE CONTROL REQUIREMENTS AND TAXATION IN THE COUNTRIES OF THEIR NATIONALITY, RESIDENCE OR DOMICILE.

NO ACTION HAS BEEN OR WILL BE TAKEN BY THE ISSUER THAT WOULD PERMIT A PUBLIC OFFERING OF THE SECURED CALLABLE BONDS OR THE DISTRIBUTION OF THE COMPANY ADMISSION DOCUMENT (OR ANY PART THEREOF) OR ANY OFFERING MATERIAL IN ANY COUNTRY OR JURISDICTION WHERE ACTION FOR THAT PURPOSE IS REQUIRED.

THE SECURED CALLABLE BONDS HAVE NOT BEEN NOR WILL THEY BE REGISTERED UNDER THE UNITED STATES SECURITIES ACT, 1933 AS AMENDED, OR UNDER ANY FEDERAL OR STATE SECURITIES LAW AND MAY NOT BE OFFERED, SOLD OR OTHERWISE TRANSFERRED, DIRECTLY OR INDIRECTLY, IN THE UNITED STATES OF AMERICA, ITS TERRITORIES OR POSSESSIONS, OR ANY AREA SUBJECT TO ITS JURISDICTION (THE "U.S.") OR TO OR FOR THE BENEFIT OF, DIRECTLY OR INDIRECTLY, ANY U.S. PERSON (AS DEFINED IN REGULATION "S" OF THE SAID ACT). FURTHERMORE, THE ISSUER WILL NOT BE REGISTERED UNDER THE UNITED STATES INVESTMENT COMPANY ACT, 1940 AS AMENDED AND INVESTORS WILL NOT BE ENTITLED TO THE BENEFITS SET OUT THEREIN.

A COPY OF THE ADMISSION DOCUMENT HAS BEEN SUBMITTED TO THE MSE IN THE CONTEXT OF AN APPLICATION FOR ADMISSION OF THE SECURED CALLABLE BONDS TO PROSPECTS MTF. THE MSE HAS AUTHORISED THE ISSUE OF THIS DOCUMENT. BY SO DOING, THE MSE DOES NOT GIVE ANY CERTIFICATION, REPRESENTATION, WARRANTY OR GUARANTEE REGARDING THE POTENTIAL RISKS INVOLVED IN INVESTING IN THE SAID SECURED CALLABLE BONDS OR THE SAFETY OF INVESTING IN SUCH SECURED CALLABLE BONDS.

THIS DOCUMENT AND ALL AGREEMENTS, ACCEPTANCES AND CONTRACTS RESULTING THEREFROM SHALL BE GOVERNED BY AND CONSTRUED IN ACCORDANCE WITH THE LAWS OF MALTA, AND ANY PERSON ACQUIRING ANY SECURED CALLABLE BONDS PURSUANT TO THE COMPANY ADMISSION DOCUMENT SHALL SUBMIT TO THE JURISDICTION OF THE MALTESE COURTS, WITHOUT LIMITING IN ANY MANNER THE RIGHT OF THE ISSUER TO BRING ANY ACTION, SUIT OR PROCEEDING IN ANY OTHER COMPETENT JURISDICTION, ARISING OUT OF OR IN CONNECTION WITH ANY PURCHASE OF SECURED CALLABLE BONDS, OR AGREEMENT, ACCEPTANCE OR CONTRACT RESULTING HEREFROM, OR THE COMPANY ADMISSION DOCUMENT AS A WHOLE.

STATEMENTS MADE IN THIS COMPANY ADMISSION DOCUMENT ARE, EXCEPT WHERE OTHERWISE STATED, BASED ON THE LAW AND PRACTICE CURRENTLY IN FORCE IN MALTA AND ARE SUBJECT TO CHANGES THEREIN.

ALL ADVISORS TO THE ISSUER AND THE GUARANTOR HAVE ACTED AND ARE ACTING EXCLUSIVELY FOR THE ISSUER AND THE GUARANTOR IN RELATION TO THIS ISSUE AND HAVE NO CONTRACTUAL, FIDUCIARY OR OTHER OBLIGATION OR RESPONSIBILITY TOWARDS ANY OTHER PERSON AND WILL, ACCORDINGLY, NOT BE RESPONSIBLE TO ANY INVESTOR OR ANY OTHER PERSON WHOMSOEVER IN RELATION TO THE TRANSACTIONS PROPOSED IN THE COMPANY ADMISSION DOCUMENT, NEITHER SHALL SUCH ADVISORS BE RESPONSIBLE FOR THE CONTENTS OF, AND ANY INFORMATION CONTAINED IN THE ADMISSION DOCUMENT, ITS COMPLETENESS OR ACCURACY OR ANY OTHER STATEMENT MADE IN CONNECTION THEREWITH THE ISSUER DISCLAIMS ANY AND ALL RESPONSIBILITY FOR ANY DEALINGS MADE, REPRESENTATIONS GIVEN, PROCESSES ADOPTED, FUNDS COLLECTED, OR APPLICATIONS ISSUED BY AUTHORISED INTERMEDIARIES IN THEIR EFFORT TO PLACE OR RE-SELL THE BONDS SUBSCRIBED BY THEM.

THE DIRECTORS OF THE COMPANY CONFIRM THAT WHERE INFORMATION INCLUDED IN THIS DOCUMENT HAS BEEN SOURCED FROM A THIRD PARTY, SUCH INFORMATION HAS BEEN ACCURATELY REPRODUCED, AND AS FAR AS THE DIRECTORS OF THE ISSUER ARE AWARE AND ARE ABLE TO ASCERTAIN FROM INFORMATION PUBLISHED BY THAT THIRD PARTY, NO FACTS HAVE BEEN OMITTED WHICH WOULD RENDER THE REPRODUCED INFORMATION INACCURATE OR MISLEADING.

UNLESS OTHERWISE STATED, THE CONTENTS OF THE ISSUER'S WEBSITE OR ANY WEBSITE DIRECTLY OR INDIRECTLY LINKED TO THE ISSUER'S WEBSITE DO NOT FORM PART OF THE COMPANY ADMISSION DOCUMENT. ACCORDINGLY, NO RELIANCE OUGHT TO BE MADE BY ANY INVESTOR ON ANY INFORMATION OR OTHER DATA CONTAINED IN SUCH WEBSITES AS THE BASIS FOR A DECISION TO INVEST IN THE SECURED CALLABLE BONDS.

THE VALUE OF INVESTMENTS CAN GO UP OR DOWN AND PAST PERFORMANCE IS NOT NECESSARILY INDICATIVE OF FUTURE PERFORMANCE. PROSPECTIVE INVESTORS SHOULD CAREFULLY CONSIDER ALL THE INFORMATION CONTAINED IN THE ADMISSION DOCUMENT AS A WHOLE AND SHOULD CONSULT THEIR OWN INDEPENDENT FINANCIAL AND OTHER PROFESSIONAL ADVISORS.

THE BONDS ARE COMPLEX FINANCIAL INSTRUMENTS AND MAY NOT BE SUITABLE FOR ALL TYPES OF RETAIL INVESTORS. A POTENTIAL INVESTOR SHOULD NOT INVEST IN THE BONDS UNLESS: i) HE/SHE HAS THE NECESSARY KNOWLEDGE AND EXPERIENCE TO UNDERSTAND THE RISKS RELATING TO THIS TYPE OF FINANCIAL INSTRUMENT; ii) THE BONDS MEET THE INVESTMENT OBJECTIVES OF THE POTENTIAL INVESTOR; AND iii) SUCH POTENTIAL INVESTOR IS ABLE TO BEAR THE INVESTMENT AND FINANCIAL RISKS WHICH RESULT FROM INVESTMENT IN THESE BONDS.

Table of contents

| | | |
|--------|---|----|
| 1 | Definitions..... | 10 |
| 2 | Summary | 17 |
| 2.1 | Introduction and Warnings | 17 |
| 2.2 | Issuer and Guarantor | 18 |
| 3 | Risk factors..... | 44 |
| 3.1 | Forward-looking statements | 45 |
| 3.2 | Suitability of Investment..... | 46 |
| 3.3 | Risks relating specifically to the Issuer | 46 |
| 3.4 | Risks related to the Group and its business | 47 |
| 3.4.13 | KA Holding's..... | 52 |
| 3.5 | Risks specific to the Secured Callable Bonds..... | 59 |
| 4 | Persons Responsible..... | 61 |
| 5 | Identity of Directors, Senior Management, Advisors and Auditors of The Issuer and Guarantor | 62 |
| 5.1 | Directors of the Issuer..... | 62 |
| 5.2 | Senior Management | 63 |
| 5.3 | Advisors to the Issuer..... | 65 |
| 6 | Information About the Issuer and The Guarantor | 66 |
| 6.1 | Information on the Issuer..... | 66 |
| 6.2 | Information on the Guarantor..... | 67 |
| 7 | Trend information | 69 |
| 7.1 | Trend information of the Guarantor | 69 |

| | | |
|------|--|-----|
| 8 | Financial information on the Issuer & Guarantor | 74 |
| 8.1 | Financial information of the Guarantor..... | 74 |
| 9 | Management and Administration | 87 |
| 9.1 | The Issuer | 87 |
| 9.2 | The Guarantor | 90 |
| 10 | Major shareholders..... | 91 |
| 10.1 | Major shareholders of the Issuer..... | 91 |
| 10.2 | Major shareholders of the Guarantor..... | 91 |
| 11 | DIVIDEND POLICY | 92 |
| 12 | Board Committees | 93 |
| 12.1 | Audit Committee..... | 93 |
| 13 | Compliance with Corporate Governance Requirements | 95 |
| 13.1 | The Issuer | 95 |
| 13.2 | The Guarantor | 96 |
| 14 | Litigation Proceedings..... | 97 |
| 15 | Additional Information | 98 |
| 15.1 | Memorandum and articles of association of the Issuer | 98 |
| 15.2 | Memorandum and articles of association of the Guarantor | 99 |
| 16 | Material Contracts..... | 101 |
| 17 | Third-Party Information, Statements by Experts and Declaration of Any Interest | 102 |
| 17.1 | Valuation reports..... | 102 |
| 17.2 | Accountants' report on prospective financial information | 102 |
| 17.3 | Interests of experts and advisers..... | 102 |
| 18 | Documents Available for Inspection | 104 |
| 19 | Consent for Use of the Company Admission Document | 105 |

| | | |
|-------|--|-----|
| 20 | Key Information | 107 |
| 20.1 | Estimated expenses and proceeds of the Issue | 107 |
| 20.2 | Reasons for the Issue and Use of Proceeds | 107 |
| 21 | Information Concerning the Secured Callable Bonds..... | 109 |
| 21.2 | General..... | 109 |
| 21.3 | Subscription | 111 |
| 21.4 | Status and Ranking of the Secured Callable Bonds | 112 |
| 21.5 | Rights attaching to the Secured Callable Bonds..... | 113 |
| 21.6 | Restrictive covenants..... | 113 |
| 21.7 | Interest | 115 |
| 21.8 | Yield | 115 |
| 21.9 | Registration, Form, Denomination and Title..... | 116 |
| 21.10 | Pricing | 116 |
| 21.11 | Payments | 117 |
| 21.12 | Redemption and Purchase..... | 118 |
| 21.13 | Events of Default | 118 |
| 21.14 | Transferability of the Secured Callable Bonds..... | 121 |
| 21.15 | Further Issues | 122 |
| 21.16 | Meetings of Bondholders..... | 122 |
| 21.17 | Authorisations and Approvals..... | 124 |
| 21.18 | Admission to Trading..... | 124 |
| 21.19 | Representations and Warranties..... | 124 |
| 21.20 | Secured Callable Bonds held jointly | 125 |
| 21.21 | Secured Callable Bonds held subject to usufruct..... | 125 |
| 21.22 | Governing law and jurisdiction..... | 125 |

| | | |
|-------|--|-----|
| 21.23 | Notices | 126 |
| 21.24 | Sinking Fund..... | 126 |
| 21.25 | Security Trust | 127 |
| 22 | Taxation | 130 |
| 22.1 | General..... | 130 |
| 22.2 | Malta Tax on Interest..... | 130 |
| 22.3 | Exchange of Information | 131 |
| 22.4 | Foreign Account Tax Compliance Act | 131 |
| 22.5 | Maltese Taxation on Capital Gains on Transfer of the Bonds | 132 |
| 22.6 | Duty on Documents and Transfers..... | 132 |
| 23 | Terms and Conditions of The Bond Issue | 133 |
| | Annex A- Property Valuations..... | |
| | Annex B - Trust Deed and Pledge Agreement | |
| | Annex C – Accountant’s Report..... | |
| | Annex D – Forecast Information of the Guarantor..... | |
| | Annex E - Summary of significant assumptions and accounting policies | |
| | Annex F- Application Form | |
| | Annex G – List of Directorships | |

1 Definitions

In this Company Admission Document, the following words and expressions shall bear the following meaning whenever such words and expressions are used in their capitalised form, except where the context otherwise requires:

| | |
|--|--|
| Act or Companies Act | the Companies Act (Chapter 386 of the laws of Malta); |
| Admission Document or Company Admission Document or Document | this document in its entirety, including all its annexes; |
| Applicant/s | a person or persons whose name or names (in the case of joint applicants) appear in the registration details of an Application Form; |
| Application/s | the application to subscribe for Secured Callable Bonds made by an Applicant/s by completing an Application Form/s and delivering same to the Placement Agent and Manager in accordance with the terms of this Company Admission Document; |
| Application Form | the form of application for subscription for Secured Callable Bonds, a specimen of which is contained in Annex F of this Company Admission Document; |
| Appropriateness Test | means the test conducted by any licensed financial intermediary, when providing an investment service (other than investment advice or portfolio management) in relation to the subscription for and the trading of Bonds, for the purpose of such licensed financial intermediary determining (after collecting the necessary information) whether the investment service or the Bonds are appropriate for the prospective Applicant or prospective transferee; |
| Bondholder | a holder of these Secured Callable Bonds; |
| Bond Issue | the issue of these Secured Callable Bonds; |

| | |
|-----------------------------|---|
| Bond Issue Price | the price of €100 per Secured Callable Bond; |
| Building Agreement | the agreement already in place with the construction company to build Centris II; |
| Business Day | any day between Monday and Friday (both days included) on which commercial banks in Malta settle payments and are open for normal banking business; |
| CAGR | compound annual growth rate; |
| Centris I | Being the office building already built and rented out in Triq il-Palazz I-Ahmar in Mriehel |
| Centris II | Being the office building still to be developed and built, adjacent to Centris I; |
| CET | Central European Time |
| Collateral or Security | the following security granted in favour of the Security Trustee for the benefit of Bondholders: <ul style="list-style-type: none"> (a) the Special Hypothec (b) the General Hypothec (c) Guarantee (d) The Pledge; |
| Company or Issuer | KA Finance plc a company registered under the Laws of Malta with company registration number C 91544; |
| Corporate Advisor | EMCS Ltd, a private limited liability company registered and incorporated under the laws of Malta with company registration number C 68521 and having its registered office situated at Level 2, Regional Business Centre, University Heights, Msida MSD 1751, Malta; |
| CSD | the Central Securities Depository of the MSE authorised in terms of Part IV of the Financial Markets Act (Chapter 345 of the laws of Malta), having its address at Garrison Chapel, Castille Place, Valletta, VLT 1063, Malta; |
| Debt-to-Total Capital Ratio | the Financial Indebtedness divided by the sum of total equity and Financial Indebtedness; |

| | |
|---------------------------------------|--|
| Directors or Board | the directors of the Issuer whose names are set out in section 5.1, and 'Director' shall be construed accordingly; |
| Early Redemption Date[s] | any date falling on or after 9 th August 2026 and until the Redemption Date, on which at the option of the Issuer, the Issuer may redeem in whole the Bond upon providing not less than [60] days' notice in writing, at the redemption prices (expressed as a percentage of the principal amount) indicated in Early Redemption Schedule (plus any accrued and unpaid interest) ; |
| Early Redemption Schedule | Should the Early Redemption Date fall between the 9th August, 2026 and the 8th August 2027 the redemption price will be equal to 103% (expressed as a percentage of the principal amount), plus any accrued and unpaid interest. Should the Early Redemption Date fall between the 9th August 2027 and the 8th August 2028 the redemption price will be equal to 102% (expressed as a percentage of the principal amount), plus any accrued and unpaid interest. Should the Early Redemption Date fall between the 9th August 2028 and the 8th August 2029 the redemption price will be equal to [100%] (expressed as a percentage of the principal amount), plus any accrued and unpaid interest; |
| EBIT | earnings before interest and taxation; |
| EBITDA | earnings before interest, taxation, depreciation and amortisation; |
| Euro or € | the lawful currency of the Republic of Malta; |
| Event(s) of Default | event(s) of default as identified in section 21.13 |
| Exchange, Malta Stock Exchange or MSE | Malta Stock Exchange p.l.c., bearing company registration number C 42525 and having its registered office at Garrison Chapel, Castille Place, Valletta VLT 1063, Malta; |
| FY | Financial Year; |
| GDPR | The Regulation (EU) 2016/679 of the European Parliament and of the Council of 27 April 2016 on the protection of natural persons with regard to the processing of personal data and on the free movement of such data; |

| | |
|---------------------------------------|--|
| General Hypothec | the General Hypothec to be granted by the guarantor in favour of the Security trustee over all its property both present and future; |
| GOPPAR | gross operating profit per available room; |
| Group or KA Group | The Guarantor (parent company) and any subsidiary and associated company or entity, including the Issuer, in which the Guarantor has a controlling interest; |
| Guarantee | the joint and several guarantees to be granted on the 12th August 2019 by the Guarantor as security for the punctual performance of the Issuer's payment obligations under the Bond Issue, subject to the terms and conditions contained in the Security Trust Deed and as the same is held on trust for the benefit of the Bondholders by the Security Trustee; |
| Guarantor, Parent, KA Holdings or KAH | KA Holdings (KAH) Limited, a company registered under the Laws of Malta with company registration number C 56023 with registered address "Project Technik", Cannon Road, Qormi; |
| IFRS | International Financial Reporting Standards as adopted by the EU; |
| Interest Cover Ratio | the profit before tax and before interest payable divided by the interest payable for the same period; |
| Interest Rate | the interest payable in connection with the Bonds, being interest from and including 9th August, 2019 at the rate of 4.75% per annum payable annually in arrears on the Interest Payment Date; |
| Interest Payment Date | annually on the 9th August of each year commencing on the 9th August, 2020 and ending with and including the Redemption date, unless part or all of the bonds are redeemed at the Issuers sole discretion on any of the Early Redemption Dates, in respect of the Bonds so redeemed; provided that any such date is not a Business Day such Interest Payment Date will be carried over to the next following day that is a Business Day; |

| | |
|--|--|
| Investment Management Policy | Policy approved by the Board of Directors of the Issuer which outlines the processes and procedure by which the bond funds will be loaned to the Guarantor. An future update to this Investment management policy will need to be approved by the Malta stock exchange and shall be published by way of company announcement |
| IRS | Inland Revenue Service; |
| Issue Date | 9th August, 2019 |
| Issue Period | 24th July, 2019 to 7th August, 2019 |
| Issuer | KA Finance Plc, a public limited liability company registered and incorporated under the Laws of Malta, with company registered number C 91544 and having its registered address at 'Project Technik', Cannon Road, Qormi; |
| Listing Authority | the board of governors, acting as the Listing Authority under the Malta Financial Services Authority Act (Chapter 330 of the laws of Malta); |
| Listing Rules | the listing rules issued by the Listing Authority, as may be amended from time to time; |
| Memorandum and Articles of Association or M&As | the memorandum and articles of association of the Issuer in force at the time of publication of the Company Admission Document; |
| MFSA | the Malta Financial Services Authority established in terms of the Malta Financial Services Authority Act (Chapter 330 of the laws of Malta); |
| NSO | National Statistics Office; |
| Placement Agent and Manager | Curmi & Partners Ltd, a private limited liability company registered and incorporated under the laws of Malta with company registration number C 3909 and having its registered office situated at Finance House, Princess Elizabeth Street, Ta' Xbiex XBX1102, Malta; |
| Pledge | This shall mean all the rights and obligations derived from the pledge agreement; |
| Pledge Agreement | The pledge agreement in place between the Pledgee and the Pledgor, the Guarantor and the Placement Agent whereby the |

| | |
|---|--|
| | Pledgee is appointed to hold the proceeds from the Bond Issue in accordance with this Company Admission Document; |
| Pledgor | Shall be construed to have the same meaning as the Issuer; |
| Pledgee | Shall be construed to have the same meaning as the Security Trustee; |
| PMLFT Regulations | Prevention of Money Laundering and Funding of Terrorism (PMLFT) Regulations made under the Prevention of Money Laundering Act, 1994 (Chapter 373 of the laws of Malta); |
| Project Technik Ltd or PTL | Project Technik LTD (PTL), is a related company also fully owned by Kurt Abela. PTL is an innovative and experience contractor with the technical, managerial and supervisory capacity to support main contractors and professional design teams from initial concept through to project completion. PTL specialises in ceiling, drywall, plastering and interior finishing works. |
| Prospects MTF | The market regulated as a multilateral trading facility operated by the MSE providing a venue for start-up and growth of small to medium-sized enterprises to float their capital (including equity or debt) on the market; |
| Prospectus Directive | Directive 2003/71/EC of the European Parliament and of the Council of 4 November 2003 on the prospectus to be published when securities are offered to the public or admitted to trading and amending Directive 2001/34/EC, as amended by Directive 2010/73/EU of the European Parliament and of the Council of 24 November 2010, and as may be further amended from time to time; |
| Redemption Date | 9th August 2029 |
| Redemption Value | the nominal value of each Bond (€100 per Secured Callable Bond) or as per as per the redemption prices in line with the Early Redemption Schedule , in the case of an early redemption; |
| Secured Callable Bond(s) or Bond(s) or Securities | the €6 million Secured Callable bonds 2026-2029 of a nominal value of €100 per bond issued at par and redeemable on the Redemption Date at their nominal value, bearing interest at the rate of 4.75% per annum; |
| Security Trust or KA Trust | the trust established in virtue of the Security Trust Deed; |

| | |
|--|--|
| Security Trust Deed or Trust Deed | the security trust deed to be signed between the Issuer, the Guarantor and the Security Trustee on the 12th August, 2019; |
| Security Trustee | EMCS International Services Ltd, a private limited liability company registered and incorporated under the laws of Malta with company registration number C25114 and having its registered office situated at Level 2, Regional Business Centre, University Heights, Msida MSD 1751, Malta |
| Small and medium-sized enterprises or SMEs | an enterprise as defined in Article 2(1) of the Companies Act (Chapter 386 of the laws of Malta) and in line with the Prospects MTF Rules |
| Sinking Fund | the sinking fund referred to in Section 21.24 of this Company Admission Document; |
| Special Hypothec | the Special Hypothec to be granted by the Guarantor in favour of the Security trustee over Centris II; |
| Suitability Test | means the process through which a licensed financial intermediary providing investment advice or portfolio management services in relation to the subscription for and trading of Bonds obtains such information from the Applicant or prospective transferee as is necessary to enable the licensed financial intermediary to recommend to or, in the case of portfolio management, to effect for, the Applicant or prospective transferee, the investment service and trading in Bonds that are considered suitable for him/her; |
| Summary | a summary of the salient features of the Document, as contained in the section entitled "Summary"; |
| Terms and Conditions | the terms and conditions of the Secured Callable Bonds which are included in section 23 of this Company Admission Document. |
| | |

2 Summary

2.1 Introduction and Warnings

2.1.1 Prospective investors are hereby warned that:

- a) this Summary is being provided to convey the essential characteristics and risks associated with the Issuer, the Guarantor and the Securities being offered pursuant to this Document. This section is merely a summary and, therefore, should only be read as an introduction to the Company Admission Document. It is not and does not purport to be exhaustive and investors are warned that they should not rely on the information contained in this Summary alone in deciding as to whether to invest in the Securities described in this Document. Any decision to invest in the Secured Callable Bonds should be based on consideration of the Company Admission Document as a whole by the investor;
- b) where a claim relating to the information contained in this Company Admission Document is brought before a court, the plaintiff investor might, under the national legislation of Malta, have to bear the costs of translating the Company Admission Document before the legal proceedings are initiated; and
- c) civil liability attaches only to those persons who have tabled the Summary including any translation thereof and who applied for its notification, but only if the Summary, when read together with the other parts of the Company Admission Document, is misleading, inaccurate or inconsistent; or does not provide key information in order to aid investors when considering whether to invest in such Securities.

2.1.2 Users of the Company Admission Document in connection with the bond issue are hereby informed that:

- a) for the purposes of any subscription for Secured Callable Bonds by an authorised intermediary and any subsequent resale, placement or other offering of Secured Callable Bonds by an authorised intermediary in circumstances where there is no exemption from the requirement to publish a Company Admission Document under the Prospects MTF Rules, the Issuer consents to the use of the Company Admission Document (and accepts responsibility for the information contained herein in accordance with the terms hereof) with respect to any such subsequent resale, placement or other offering of Secured Callable Bonds, provided this is limited only: (i) to the authorised intermediary(ii) to any resale, placement or other offering of Secured Callable Bonds subscribed for as aforesaid, taking place in Malta; and (iii) to any resale, placement or other offering of Secured Callable Bonds subscribed for as aforesaid, taking place within the period of 60 days from the date of the Company Admission Document;

- b) in the event of a resale, placement or other offering of Secured Callable Bonds by an authorised financial intermediary said authorised financial intermediary shall be responsible to provide information to prospective investors on the terms and conditions of the resale, placement or other offering at the time such resale, placement or other offering is made; and
- c) any new information with respect to authorised financial intermediaries unknown at the time of the approval of the Company Admission Document will be made available through a company announcement which will also be made available on the Prospects MTF website and the Issuer's website.

2.2 Issuer and Guarantor

The legal and commercial name of the Issuer is KA Finance plc (company registration number C 91544).

The Issuer was registered in Malta in terms of the Act on 22nd April 2019 as a public limited liability company and is domiciled in Malta.

The legal and commercial name of the Guarantor is KA Holdings Limited (registration number C 56023).

The Guarantor was registered in Malta in terms of the Act on 19th April 2012 as a private limited liability company and is domiciled in Malta.

2.2.1 The following is an overview of the most significant trends affecting the Issuer and the Guarantor and the markets in which they operate

The Issuer has been set up to act as a financing company and its business is limited to the raising of capital and the lending of such capital to the Guarantor, the collection of interest from the Guarantor and the settlement, in turn, of interest payable on capital raised from third parties. The Issuer does not have any substantial assets. Its role is limited to the financing of the Guarantor's operations and it is, accordingly, fully dependent on the cash flows of the Guarantor.

The principal objects of the Guarantor relate to developing and building office space in Mriehel and the renting out of such space, developing an apartment complex in Swieqi for short-term rental purposes and the refurbishment and eventual operation of a boutique hotel in Gzira.

To date the Guarantor has focused on renting out office space from its Centris Business Gateway Building in Mriehel, referred to as Centris I.

Without prejudice to the risks identified in this Document, as at the time of publication of the Company Admission Document, the Issuer and the Guarantor consider that generally they shall be

subject to the normal business risks associated with the business in which they operate, and, barring unforeseen circumstances, do not anticipate any particular trends, uncertainties, demands, commitments or events outside the ordinary course of business that could be deemed likely to have a material adverse effect on the upcoming prospects of KA Holdings and its business, at least with respect to the current financial year. However, investors are strongly advised to carefully read the risk factors in the Company Admission Document.

The Guarantor shall grant the Guarantee in favour of the Security Trustee acting in its capacity as trustee for the Bondholders.

The following is a brief synopsis of the significant trends affecting the key areas of operation of KA Holdings

2.2.1.1 Office space rental market

Malta is presently experiencing an economic boom. The real GDP growth experienced in Malta is outlined below.

The 'construction' and 'real estate activities' experienced a strong growth in the past years. Real estate activities registered a 12% growth in GDP output in the period Q1 – Q3 2018, when compared to the same period in 2017.

A market exercise in which around 40 local real-estate agents participated through telephone interviews, was carried out during the first weeks of January 2018¹.

26% of the respondents attribute the surge in demand for property to the increase in the number of foreign workers in Malta. 20% of local real-estate operators deem that the increase in the investment in the buy-to-let market has fuelled the activity in the industry. Other factors affecting the demand for property were determined to be the growth in disposable income, the Government initiatives in the sector, the increase in demand for office space and the Individual Investor Programme.

¹ <https://www.pwc.com/mt/en/publications/middlemarketbarometer/barometer-real-estate-january-2018.html>

2.2.1.2 The hospitality industry

The hospitality industry in Malta has welcomed the increase in tourist arrivals throughout the past four years with a complementary increase in performance. Data from the Malta Hotels and Restaurants Association illustrates that over the past four years all hotel categories managed to register year-on-year increases in both occupancy and average daily rate. The improvement in both the average daily rate and occupancy has positively impacted the industry's bottom-line.

2.2.1.3 The overall tourism performance in Malta

The Maltese tourism industry has, in recent years, been renowned for its unabated growth, with each passing year yielding new record highs of inbound tourists visiting the island. Indeed, the tourism industry is considered to be a crucial pillar of the economy as, directly and indirectly, it is estimated to account for 29% of Malta's GDP (National Tourism Policy 2015-2020).

The strong performance in the tourism sector observed over the past few years has persisted during 2017 in terms of inbound tourists. NSO data for 2018², revealed that the influx for the year stood at 2.6 million tourists – representing an increase of 14.3% over the previous year³. Over the past 5 years (2014-2018), there has been a compounded annual growth rate of 11.33% per annum. According to the NSO, this improvement was mostly driven by an increase in the number of leisure tourists. Furthermore, 65.9% of tourists organised their own stay and opted for a non-package holiday.

2.2.2 Group structure

The Issuer is a fully owned subsidiary of the Guarantor. The Issuer is a special purpose vehicle setup to act as a financing company for the needs of KA Holdings Ltd (KAH), and, as such, it is dependent on the business prospects and operating results of its Parent.

²

https://nso.gov.mt/en/News_Releases/View_by_Unit/Unit_C3/Tourism_Statistics/Documents/2019/News2019_017.pdf

³https://nso.gov.mt/en/News_Releases/View_by_Unit/Unit_C3/Tourism_Statistics/Documents/2019/News2019_017.pdf

The organisational structure of the Group as at the Company Admission document is illustrated in the below diagram:

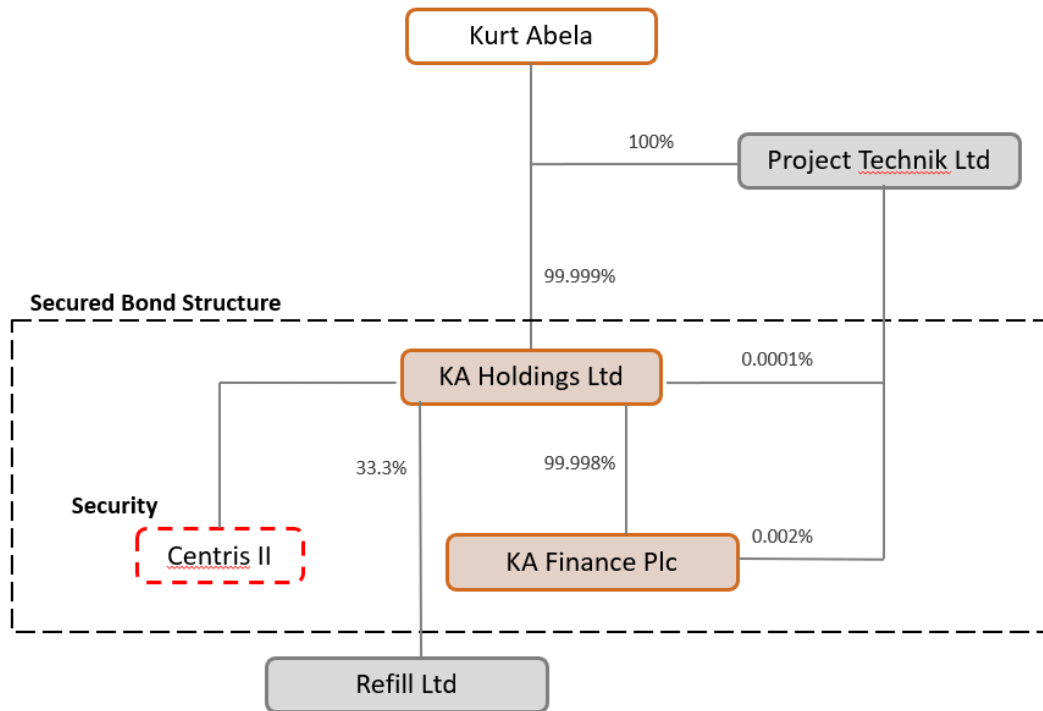

The Issuer was set up on 22nd April 2019 and since incorporation to the date of the Company Admission Document no financial statements have been prepared. There has not been any significant change in the financial or trading position of the Issuer which has occurred since the Company's date of incorporation. The Guarantor was registered and incorporated on 19th April 2012 and since incorporation to the date of the Company Admission Document 6 sets of financial statements have been prepared. The Guarantor's historical financial information for the financial year ended 31st December 2017, as audited by Grant Thornton is set out in the audited financial statements of the Guarantor and is available for inspection on the Guarantor's website (www.kaholdings.com.mt) and from the registered office of the Guarantor during office hours. In this Company Admission Document, the use of actual financial information with regards the Guarantor is being used for the financial year 2018, which has been audited.

2.2.3 Review of Group Ownership and Financial Performance of Guarantor

The Issuer does not intend to undertake any trading activities itself apart from the raising of capital and the advancing thereof to the Guarantor. Accordingly, the Issuer is economically dependent on the financial and operating performance of the Guarantor.

The Issuer does not have any substantial assets and is essentially a special purpose vehicle that was set up to act as a financing company. The Issuer is, therefore, intended to serve as a vehicle through which KA Holdings will continue to finance its future projects.

The operations of the Guarantor have, to date, been largely the purchase of land and the development of such land in office space for rent in Mriehel (Centris I).

The Issuer was set up and established to act as a finance company. In terms of its Memorandum of Association, the main object for which the Issuer is constituted is to carry out the business of a finance and investment company and in particular to provide financing and re-financing to meet funding requirements of the business of the Group of Companies which the Company forms part of. The issue of bonds falls within the objects of the Issuer. Clause 3 of the Memorandum of Association contains the full list of objects of the Issuer.

In terms of its Memorandum of Association, the Guarantor is, amongst other things, empowered to secure and guarantee any debt, liability or obligation of any third party.

The Issuer's current authorised and issued share capital is €50,000 divided into (i) 49,999 ordinary shares of €1 each, fully paid-up and held by the Guarantor; and (ii) 1 ordinary share of €1, fully paid-up and held by Project Technik LTD.

Project Technik LTD (PTL), is a related company also fully owned by Kurt Abela. PTL is an innovative and experience contractor with the technical, managerial and supervisory capacity to support main contractors and professional design teams from initial concept through to project completion. PTL specialises in ceiling, drywall, plastering and interior finishing works. Over the past 12 years PTL has established itself as a significant player in the market having successfully transformed hundreds of properties and executed numerous high-profile projects including the Life Sciences Park, Vodafone Skyparks, Midi Q1, Toly factory, Waterfront Hotel and various secondary schools.

The Guarantor's current authorised and issued share capital is €150,000 divided into (i) 149,999 ordinary shares of €1 each, fully paid-up and held by Kurt Abela and (ii) 1 ordinary share of €1, fully paid-up and held by Project Technik LTD.

The Issuer and the Guarantor are, therefore, ultimately owned 100% by Mr Kurt Abela.

For the purposes of the Guarantee, the Guarantor irrevocably and unconditionally guarantees to the Security Trustee, for the benefit of the Bondholders that if for any reason the Issuer fails to pay any sum payable by it to such Bondholder pursuant to the Terms and Conditions (Section 23) of

the Secured Callable Bonds as and when the same shall become due under any of the foregoing, it will pay on demand the indebtedness to the Security Trustee.

The obligations of the Guarantor under the Guarantee shall remain in full force and effect until no sum remains payable to any Bondholder pursuant to the issue of the Secured Callable Bonds.

2.2.3.1 Extracts of audited financial statements of KA Holdings (Guarantor)

Income statement for the years ended 31st December 2018 & 2017

| | 2018 | 2017 |
|---|------------------|------------------|
| | | (as restated) |
| | € | € |
| Rental income | 603,368 | 441,788 |
| Other income | 82,239 | 42,142 |
| Administrative expenses | (85,484) | (50,922) |
| Operating profit | 600,123 | 433,008 |
| Fair value gains on investment property | 1,071,115 | 2,258,060 |
| Finance costs | (129,386) | (89,492) |
| Profit before tax | 1,541,852 | 2,601,576 |
| Tax expense | (186,505) | (330,268) |
| Profit for the year | 1,355,347 | 2,271,308 |

Statement of financial position for the years ended 31st December 2018 & 2017

| | 31 December 2018 | 31 December 2017 (as restated) | 1 January 2017 (as restated) |
|---|---------------------|--------------------------------------|------------------------------------|
| | € | € | € |
| Assets | | | |
| Non-current | | | |
| Financial assets at fair value through other comprehensive income (2017: Available-for-sale financial assets) | 36,736 | 36,736 | 36,736 |
| Investment property | 12,859,623 | 10,800,000 | 7,500,000 |
| | 12,896,359 | 10,836,736 | 7,536,736 |
| Current | | | |
| Trade and other receivables | 350,813 | 223,789 | 109,889 |
| Cash and cash equivalents | 12,361 | 42,282 | 2,565 |
| | 363,174 | 266,071 | 112,454 |
| Total assets | 13,259,533 | 11,102,807 | 7,649,190 |
| | | | |
| | 31 December 2018 | 31 December 2017 (as restated) | 1 January 2017 (as restated) |
| | € | € | € |
| Equity | | | |
| Share capital | 150,000 | 150,000 | 150,000 |
| Revaluation reserve | 6,739,623 | 5,764,508 | 3,770,448 |
| Retained earnings | 660,718 | 280,486 | 3,238 |
| Total equity | 7,550,341 | 6,194,994 | 3,923,686 |
| Non-current liabilities | | | |
| Borrowings | 1,855,722 | 1,914,123 | 1,081,521 |
| Trade and other payables | 1,218,372 | 403,053 | 658,844 |
| Deferred tax liability | 960,000 | 864,000 | 600,000 |
| | 4,034,094 | 3,181,176 | 2,340,365 |
| Liabilities | | | |
| Current | | | |
| Borrowings | 126,832 | 137,872 | 104,332 |
| Trade and other payables | 1,453,840 | 1,518,076 | 1,276,386 |
| Current tax liability | 94,426 | 70,689 | 4,421 |
| | 1,675,098 | 1,726,637 | 1,385,139 |
| Total liabilities | 5,709,192 | 4,907,813 | 3,725,504 |
| Total equity and liabilities | 13,259,533 | 11,102,807 | 7,649,190 |

Statement of cash flows for the years ended 31st December 2018 & 2017

| | 2018 | 2017 |
|---|------------------|--------------------|
| | | (as restated) |
| | € | € |
| Operating activities | | |
| Profit before tax | 1,541,852 | 2,601,576 |
| Adjustments | (941,729) | (2,168,568) |
| Net changes in working capital | 624,059 | (159,120) |
| Interest paid | (129,386) | (89,492) |
| Income tax paid | (66,768) | - |
| Net cash generated from operating activities | 1,028,028 | 184,396 |
| Investing activity | | |
| Payments for improvements to investment property | (988,508) | (1,010,822) |
| Net cash used in investing activity | (988,508) | (1,010,822) |
| Financing activity | | |
| (Re-payment of) advances from bank borrowings | (69,441) | 892,373 |
| Net cash generated from financing activity | (69,441) | 892,373 |
| Net change in cash and cash equivalents | (29,921) | 65,947 |
| Cash and cash equivalents, beginning of year | 42,282 | (23,665) |
| Cash and cash equivalents, end of year | 12,361 | 42,282 |

2.2.4 The Bonds

The Issuer shall issue an aggregate of €6 million in Secured Callable Bonds 2026-2029 having a nominal value of €100 per Secured Callable Bond, subject to a minimum subscription of €2,000 in Secured Callable Bonds and multiples of €100 thereafter.

The Secured Callable Bonds will be issued in fully registered form and will be represented in uncertificated form by the appropriate entry in the electronic register maintained on behalf of the Issuer at the CSD. On admission to trading on Prospects MTF, the Secured Callable Bonds will have the following ISIN: MT0002301209. The Secured Callable Bonds shall bear interest at the rate of 4.75% per annum. The Secured Callable Bonds shall be repayable in full upon maturity on the redemption date unless previously re-purchased and cancelled, or unless the Bonds are otherwise redeemed at the option of the Issuer on any of the early redemption dates as described in Section 3.5.1

The Bond Issue is secured through the Collateral in favour of the Security Trustee acting in its capacity as trustee for the benefit of Bondholders.

The Secured Callable Bonds are all denominated in Euro (€).

The Secured Callable Bonds are freely transferable and, once admitted to the Prospects MTF, shall be transferable only in whole in accordance with the rules and regulations of the MSE applicable from time to time.

Investors wishing to participate in the Secured Callable Bonds will be able to do so by duly executing the appropriate Application Form in relation to the Secured Callable Bonds. Execution of the Application Form will entitle such investor to:

- i. the receipt of interest;
- ii. the repayment of capital as and when due;
- iii. the benefit of the Collateral through the Security Trustee, as explained in 21.25 below;
- iv. attend, participate in and vote at meetings of Bondholders in accordance with the Terms and Conditions of the Bond Issue; and
- v. enjoy all such other rights attached to the Bonds emanating from the Company Admission Document.

Following the issue of the Bonds and application of the proceeds, the Security Trustee for the benefit of Bondholders shall be guaranteed, in respect of both the interest and the principal amount due, by the Guarantor in terms of the Guarantee.

Security for the fulfilment of the Issuer's obligations in terms of the Bond Issue is being granted in favour of the Security Trustee for the benefit of Bondholders with the granting of the Collateral Rights as described hereunder.

Accordingly, Bondholders shall have the benefit of the collateral rights in accordance with the terms of the Security Trust Deed, as set out in section 21.25 of this Admission Document. The security shall be constituted in favour of the Security Trustee for the benefit of all Bondholders.

Specifically, the Issuer and KA Holdings have entered into the Security Trust Deed (as per Annex B) with the Security Trustee which sets out the covenants of the Issuer and guarantor to secure, pursuant to the granting of the security rights to be described below and up to the value of said security rights from time to time, the payment of the principal amount under the Bonds on the Redemption Date and interest thereon on each Interest Payment Date, as well as to observe all obligations under the Security Trust Deed. The Collateral Rights will be vested in the Security Trustee for the benefit of the Bondholders in proportion to their respective holding of Bonds.

The issue and allotment of the Secured Callable Bonds is conditional upon the constitution of the security being in place prior to Admission date and upon the Secured Callable Bonds being admitted to the Prospects MTF List of the MSE. The Secured Callable Bonds shall bear interest from and including 9th August, 2019 at the rate of 4.75% per annum on the nominal value thereof, payable annually in arrears on each Interest Payment Date. The first interest payment will be affected on 9th August, 2020 (covering the period 9th August 2019 to 8th August, 2020). For Secured Callable Bonds issued at the Bond Issue Price, the gross yield calculated on the basis of the Interest, the Bond Issue Price and the Redemption Value of the Secured Callable Bonds at Redemption Date is 4.75%. The Bonds will mature on XXXXX 2029, unless previously repurchased and cancelled, or the Bonds are otherwise previously redeemed at the option of the Issuer on any of the Early Redemption Dates as described in Sections 2.2.6 (3) and 21.12 The Issuer may at any time purchase the Secured Callable Bonds in the open market or otherwise at any price. Any purchase by tender shall be made available to all Bondholders alike. All Secured Callable Bonds so purchased or redeemed will be cancelled forthwith and may not be re-issued or re-sold. An application has been made to the MSE for the Secured Callable Bonds to be issued pursuant to the Company Admission Document and simultaneously to be admitted and traded on its Prospects MTF. The Secured Callable Bonds are expected to be admitted to the MSE with effect from 14th August, 2019 and trading is expected to commence on 16th August, 2019.

2.2.5 Risks

Holding of a Secured Callable Bond involves certain risks. Prospective investors should carefully consider, with their own independent financial and other professional advisors, the following risk factors and other investment considerations as well as all the other information contained in the Company Admission Document before deciding to acquire the Secured Callable Bonds.

Prospective investors are warned that by investing in the Secured Callable Bonds they may be exposing themselves to significant risks that may have the consequence of losing a substantial part or all of their investment.

The Company Admission Document contains statements that are, or may be deemed to be, “forward-looking statements”, which relate to matters that are not historical facts and which may involve projections of future circumstances. These forward-looking statements are subject to a number of risks, uncertainties and assumptions and important factors that could cause actual risks to differ materially from the expectations of the Issuer’s and Guarantor’s respective directors. No assurance is given that the future results or expectations will be achieved.

In so far as prospective investors seek advice from authorised financial intermediaries concerning an investment in the Secured Callable Bonds, authorised financial intermediaries are to determine the suitability of prospective investors’ investment in the Bonds in the light of said prospective investors’ own circumstances. The Secured Callable Bonds may not be a suitable investment for all investors. In particular, an authorised intermediary should determine whether each prospective investor: (i) has sufficient knowledge and experience to make a meaningful evaluation of the Secured Callable Bonds, the merits and risks of investing in the Secured Callable Bonds and the information contained or incorporated by reference in the Company Admission Document or any applicable supplement; (ii) has access to, and knowledge of, appropriate analytical tools to evaluate, in the context of his/her/its particular financial situation, an investment in the Secured Callable Bonds and the impact the Secured Callable Bonds will have on his/her/its overall investment portfolio; (iii) has sufficient financial resources and liquidity to bear all the risks of an investment in the Bonds (iv) understands thoroughly the terms of the Secured Callable Bonds and is familiar with the behaviour of any relevant indices and financial markets; and (v) is able to evaluate possible scenarios for economic, interest rate and other factors that may affect his/her/its investment and his/her/its ability to bear the applicable risks.

Below is a summary of the principal risks associated with the Secured Callable Bonds of the Company

– there may be other risks which are not mentioned in this Summary and/or in this Company Admission Document. Investors are therefore urged to consult their own financial or other professional advisors with respect to the suitability of investing in the Secured Callable Bonds.

Risks relating specifically to the Issuer

i. The Issuer has the function of acting as a finance company, with its main purpose being that of financing the funding requirements of the Guarantor, and as such, its assets consist of the loans to be issued to the Guarantor, consequently, the Issuer is entirely dependent on receipt of interest and loan repayments from the Guarantor.

ii. The Group is ultimately owned exclusively by Kurt Abela. Accordingly, the ultimate owner of KA Holdings, who is also a Director of the Issuer and the Guarantor, exercises effective control over the Issuer. Kurt Abela is considered instrumental to the Group and the Issuer and any

unexpected dilution, whether by sale and/or transfer of any of his interest or by way of transmission thereof of any other incapacity, in his control or influence over the Issuer and/or KA Holdings and its businesses could have an adverse effect on the Issuer. There can be no assurance that such individual will not at any time during the term of the Bonds dispose of any interest, direct or indirect, in the Issuer or KA Holdings.

iii. This Company Admission Document features projected revenues of KA Holdings. Forecasts are inherently subject to the risks of adverse unexpected events which may affect the revenue streams and profitability of KA Holdings or the Issuer. The forecasts set out in this Company Admission Document are dependent on a number of assumptions and future expectations that may or may not occur. The non-occurrence of these future expectations could have material effects on the financial position and results of KA Holdings and the Issuer.

Risks relating to KA Holdings and its Business

i. The Group may be subject to changing conditions in the office space rental market and in the hospitality industry which is directly linked with the tourism industry in Malta.

ii. KA Holdings is dependent on its key personnel and employees and the loss of such persons, or difficulties in attracting new employees, may impact the business and ability to implement current and future strategies;

iii. All industries are subject to legal claims, with and without merit. Defence and settlement costs can be substantial, even with respect to claims that have no merit. Due to the inherent uncertainty of the litigation and dispute resolution process, there can be no assurance that the resolution of any particular legal proceeding or dispute will not have a material adverse effect on KA Holding's future cash flow, results of operations or financial condition.

iv. KA Holdings shall maintain insurance at levels determined to be appropriate in light of the cost of cover and the risk profiles of its business. Recovering losses from insurers may be difficult and time-consuming, and KA Holdings may be unable to recover the full loss incurred. No assurance can be given that KA Holdings current insurance coverage would be sufficient to cover all potential losses nor that an appropriate coverage would always be available at acceptable commercial rates.

v. KA Holdings has a material amount of debt and may incur additional debt in connection with its future growth. The Group's indebtedness could adversely affect its financial position as well as its ability to raise further finance in the future.

vi. KA Holdings may also be subject to increases in operating and other expenses which could impact its financial performance and position.

vii. KA Holdings may be exposed to the risks associated with the effects of fluctuations in the prevailing levels of the market interest rates on its financing position and cash flows.

viii. KA Holdings is at risk in relation to changes in any applicable laws and regulations, including changes to the interpretation thereof, which cannot be predicted. No assurance can be given as to the impact of any possible judicial decision, change in law, regulation or administrative practice, after the date of this Company Admission Document, on the business and operations of the Group.

Risks relating to KA Holdings: Office Space Rental Market

i. The Building Agreement agreed by the Guarantor with the construction company in constructing Centris II may be adversely affected by a number of factors, including, delays in finalising the building, lack of workers to complete the building in time and bad workmanship.

ii. The office space rental market may be affected by various factors, including changing demand, changes in general economic conditions, changing supply within a particular area of competing space and lack of foreign businesses coming to Malta requiring new office space.

iii. KA Holdings plans to initiate the building and finishing-off of Centris II upon receipt of the Bond proceeds. KA Holdings will be subject to a number of specific risks normally encountered in similar developments, including the risk of cost overruns and thus the risk

of insufficiency of resources to complete the development. The building permit is already in hand.

- iv. Health and Safety Issues might arise that would require the incurrence of further costs to reduce Health and Safety related risks. Accidents might occur during construction which might result in delays to have the building completed, as well as possible claims for compensation of damages and/or other liability issues.

Risks relating to KA Holdings: The Hospitality Industry

- I. The proceeds of the Bond will partly be used to develop an apartment complex in Swieqi to have them rented out on short lets and the refurbishment and eventual operation of a Boutique Hotel in Gzira. Even though dedicated personnel will be employed to run this side of the business, KA Holdings has no history in operating an apartment complex or boutique hotel. Consequently, should this area of the business be unprofitable, this could have a material adverse effect on other areas of the business run by KA Holdings.
- II. Malta Tourism Authority (MTA) licenses required are still to be applied for. There could be a delay in having these licences acquired, which would result in a delay in having the projected revenues materialised. There is also the risk of the MTA licence not being achieved at all, meaning that KAH would not be able to carry out its hospitality related business.
- III. KA Holding's hospitality operations are subject to external factors that could adversely affect its business, many of which are beyond KA Holding's control, including:
 - changes in travel patterns and cutbacks on Malta-bound airline routes;
 - changes in laws and regulations on employment, health and safety, environmental concerns, fiscal policies, zoning and development, and related costs of compliance;
 - the impact of increased threats of terrorism, impediments to means of transportation, extreme weather conditions, natural disasters, travel-related accidents, and outbreaks of health concerns; and

- increases in operating costs due to inflation, employment costs and healthcare-related costs, utility costs, increased taxes and insurance costs.

These factors may adversely impact room rates and occupancy levels at KA Holding's apartment complex or boutique hotel and reduce its revenue, which could have a material adverse effect on the KA Holding's financial condition and results of operations.

- IV. Furthermore, the success of KA Holding's hospitality operations is dependent on the preferences of customers and its ability to swiftly identify and capitalise on emerging consumer trends. If KA Holdings were to be unable to do so, it could experience reduced rates and occupancy levels, which could have a material adverse effect on the operational results.
- V. KA Holdings hospitality operations are susceptible to increasing competition, which may negatively impact the sales revenue and profitability in the hospitality sector. In addition, many of KA Holding's current and potential competitors may have greater name recognition, a larger customer base and more resources than KA Holdings.
- VI. A decline in the competitive strength of KA Holdings could adversely affect the results of operations. In particular, KA Holdings may be compelled, by the strength of its competitors that are able to supply services at lower prices, to reduce its own prices. The ability of KA Holdings to maintain or increase its profitability will be dependent on its ability to offset such decreases in the prices and margins of its accommodation and services.

Essential information on the key risks specific to the Secured Callable Bonds

An investment in the Secured Callable Bonds involves certain risks, including those set out below in this Section. The Bonds are complex financial instruments and may not be suitable for all types of retail investors. A potential investor should not invest in the Bonds unless: i) he/she has the necessary knowledge and experience to understand the risks relating to this type of financial instrument; ii) the Bonds meet the investment objectives of the potential investor; and iii) such potential investor is able to bear the investment and financial risks which result from investment in these Bonds. In deciding whether to make an investment in the Secured Callable Bonds, prospective investors are advised to carefully consider, with their own independent financial and other (including tax, legal and regulatory) professional advisors, the following risk factors (not listed in order of priority) and other investment considerations, together with all the other information contained in the Company Admission Document:

- i. Prior to the Bond Issue, there has been no public market nor trading record of the Secured Callable Bonds within or outside Malta. Due to the absence of any prior

market for the Secured Callable Bonds, there can be no assurance that the Bond Issue Price will correspond to the price at which the Secured Callable Bonds will trade in the market subsequent to the Bond Issue;

- ii. Only upon successful admission, may the Secured Callable Bonds be traded on Prospects MTF but will NOT be traded on any regulated market. Hence, the market for the Secured Callable Bonds may be less liquid than a regulated market and a Bondholder may find it more difficult to identify willing buyers for their Secured Callable Bonds. The existence of an orderly and liquid market depends on a number of factors. Accordingly, there can be no assurance that an active secondary market for the Bonds will develop, or if it develops, that it will continue. Furthermore, there can be no assurance that an investor will be able to sell or otherwise trade in the Secured Callable Bonds at all;
- iii. A Bondholder will bear the risk of any fluctuations in exchange rates between the currency of denomination of the Secured Callable Bonds (€) and the investor's currency of reference, if different;
- iv. No prediction can be made about the effect which any future public offerings of the Issuer's securities, or any takeover or merger activity involving the Issuer, will have on the market price of the Secured Callable Bonds prevailing from time to time;
- v. The Issuer is entitled to issue Secured Callable Bonds bearing a fixed rate of interest. Investment in such fixed rate Secured Callable Bonds involves the risk that subsequent changes in market interest rates may adversely affect the market value of the said Secured Callable Bonds. Investors should also be aware that the price of the fixed rate bonds moves adversely to changes in interest rates;
- vi. The Issuer has the option to redeem the Bonds, in whole at a price as described in Section 3.5.1, on any of the Early Redemption Dates, together with any unpaid interest until the time of redemption. This optional redemption feature may have a negative impact on the market value of the Bonds. During a period when the Issuer may opt to redeem the Bonds, the market value may not rise considerably above the price at which the Bond will be redeemed. Should the Issuer decide to redeem the Bonds on any of the Early Redemption Dates, the Bondholder may not be able to re-invest the proceeds from the redemption at yields that would have been received on the Bonds had they not been redeemed;
- vii. The value of investments can go up or down and past performance is not necessarily indicative of future performance. The nominal value of the Secured Callable Bonds will be repayable in full upon maturity on the Redemption Date unless the Secured Callable Bonds are previously re-purchased and/or cancelled or

unless otherwise previously redeemed at the option of the Issuer on any of the early redemption dates.;

- viii. Application has been made to the MSE for the Secured Callable Bonds to be admitted and traded on Prospects MTF once the Secured Callable Bonds are authorised as admissible by the MSE. Prospects MTF is a market regulated as a multilateral trading facility and operated by the MSE and provides a venue for SMEs to float their securities. Consequently, this market is designed primarily for companies to which a higher risk than that associated with established companies tends to be attached. A prospective investor should be aware of the potential risks in investing in such companies and should make the decision to invest only after careful consideration and consultation with his or her own independent financial advisor;

2.2.6 Use of Bond Issue proceeds

The proceeds from the Bond Issue, which net of issue expenses are expected to amount to approximately €5,880,000. will be used by the Issuer for the following purposes in the following order of priority, and should the amount not be utilised in full, such additional proceeds will cascade according to the following order of priority:

- A. A maximum amount of €2,000,000 of the proceeds from the Secured Callable Bonds will be advanced under title of loan to the Guarantor to be utilised for settlement by the Guarantor with regards the purchase price of the land on which Centris II will be built upon. More details in section 8.1.4.1. and section 21.25.1
- B. An amount of €2,900,000 of the net proceeds from the Secured Callable Bonds will be advanced by the Issuer under title of loan to the Guarantor to be utilised in order to develop the Centris II property in Mriehel. This amount would cover all constructions and finishing works. More details in Section 8.1.4.1;
- C. An amount of €800,000 of the proceeds from the Secured Callable Bonds will be advanced by the Issuer under title of loan to the Guarantor to be utilised to build and finish off the luxury apartments in Swieqi. More details in Section 8.1.4.2;

- D. An amount of €180,000 of the proceeds from the Secured Callable Bonds will be advanced by the Issuer under title of loan to the Guarantor to build and finish off the Boutique Hotel in Gzira. More details in Section 8.1.4.3;

Funds will be utilised in order of priority shown above to ensure that the project with the highest priority is concluded.

In the event that the Issuer does not receive subscriptions for the full €6.0 million in Secured Callable Bonds, the Issuer will proceed with the admission of the amount of Secured Callable Bonds subscribed for, however, should the amount of Secured Callable Bonds subscribed for be less than €4.0 million (the "Minimum Amount"), the Issuer will return the amount of Secured Callable Bonds subscribed for, to Bondholders. Any residual amounts required by the Issuer for the purposes of the uses specified in this section which shall not have been raised through the Bond Issue, subject to the condition that the amount of Secured Callable Bonds subscribed for is not required to be returned to Bondholders, shall be financed from the Group's general cash flow and/or bank financing.

The issue and allotment of the Secured Callable bonds is conditional upon the constitution of the security being in place prior to Admission date and upon the Secured Callable bonds being admitted to the Prospects MTF list.

The following is a synopsis of the general Terms and Conditions applicable to the Secured Callable Bonds. Subject to the satisfaction of the suitability and appropriateness tests, a Bondholder is deemed to have invested only after having received, read and understood the contents of the Company Admission Document, including the full terms and conditions contained therein and in the annexes thereto:

1. Form, Denomination and Title

The Secured Callable Bonds will be issued in fully registered form in denominations of any integral multiple of €100 provided that on subscription the Bonds will be issued for a minimum of €2,000 per individual Bondholder. An authorised intermediary subscribing to the Bonds through nominee accounts for and on behalf of clients shall apply the minimum subscription amount of €2,000 to each underlying client.

2. Redemption and purchase

Unless previously purchased and cancelled, the Issuer hereby irrevocably covenants in favour of each Bondholder that the Secured Callable Bonds will be redeemed at their nominal value (together with interest accrued to the date fixed for redemption) on 9th August, 2029. Subject to the provisions of this paragraph, the Issuer may at any time purchase Secured Callable Bonds in the open market or otherwise at any price. Any purchase by tender shall be made available to all Bondholders alike. All Secured Callable Bonds so purchased will be cancelled forthwith and may not be re-issued or re-sold.

3. Early redemption

On or after 9th August 2026, at the option of the Issuer, the Issuer may redeem in whole the Bond upon providing not less than [60] days' notice in writing, at the redemption prices (expressed as a percentage of the principal amount) indicated in the below Early Redemption Schedule (plus any accrued and unpaid interest), during the 12 month period commencing on the 9th August, 2026 of the years indicated in the below Early Redemption Schedule:

Early Redemption Schedule

9th August 2026 to 8th August 2027 – 103%

9th August 2027 to 8th August 2028 – 102%

9th August 2028 to 8th August 2029 – 100%

As a result of the Early Redemption option, the bonds are complex financial instruments.

4. Payments

Payment of the principal amount of the Secured Callable Bonds will be made within 7 days of the Redemption Date in Euro by the Issuer to the person in whose name such Bonds are registered, with interest accrued up to the Redemption Date, by means of direct credit transfer into such bank account as the Bondholder may designate from time to time, provided such bank account is denominated in Euro. Payment of Interest on a Secured Callable Bond will be made to the person in whose name such Bond is registered at the close of business 15 days prior to the Interest Payment Date, by means of a direct credit transfer into such bank account as the Bondholder may designate, from time to time. Such payment shall be affected within 7 days of the Interest Payment Date.

5. Interest and Yield

The Secured Callable Bonds shall bear interest at the rate of 4.75% per annum payable annually on 9th August of each year. Interest shall accrue as from 9th August 2019. The first Interest Payment

Date following the issuance of this Company Admission Document shall be 9th August 2020. Any Interest Payment Date which falls on a day other than a Business Day will be carried over to the next following day that is a Business Day.

The gross yield calculated on the basis of the interest, the Bond Issue Price and the Redemption Value of the Secured Callable Bonds at Redemption Date, is 4.75%

6. Status of the Secured Callable Bonds

The Secured Callable Bonds secured by the Collateral as described in section 21.25 shall constitute the general, direct, secured and unconditional obligations of the Issuer and shall at all times rank *pari passu*, without any priority or preference among themselves. Furthermore, subject to the restrictive covenant clause (section 21.6 of this Admission Document), third-party security interests may be registered which will rank in priority to the Bonds against the assets of the Issuer for so long as such security interests remain in effect. The Secured Callable Bonds shall be guaranteed in respect of both the interest due and the principal amount under said Secured Callable Bonds by the Guarantor in terms of the Guarantee.

6. Events of Default

Section 21.13 sets out a list of events of default the occurrence of which would result in the Secured Callable Bonds becoming immediately due and repayable at their principal amount, together with accrued interest.

7. Transferability of the Secured Callable Bonds

The Secured Callable Bonds are freely transferable and once admitted to the Prospects MTF, shall be transferable only in whole (in multiples of €100) in accordance with the rules and regulations of Prospects MTF and the MSE applicable from time to time. If the Secured Callable Bonds are transferred in part, such an attempted partial transfer will not be cleared, and the transferee thereof will not be registered as a Bondholder or become entitled to claim from the Issuer any purported benefit therefrom.

8. Register of Bondholders

Certificates will not be delivered to Bondholders in respect of the Secured Callable Bonds in virtue of the fact that the entitlement to Secured Callable Bonds will be represented in an uncertificated form by the appropriate entry in the electronic register maintained on behalf of the Issuer by the

CSD. There will be entered in such electronic register the names, addresses, identity card numbers, registration numbers, Legal Entity Identifier (LEI) and MSE account numbers of the Bondholders and particulars of the Secured Callable Bonds held by them respectively, and the Bondholders shall have, at all reasonable times during business hours as defined by the MSE, access to the register of Bondholders held at the CSD for the purpose of inspecting information held on their respective account.

9. Further Issues

The Issuer may, from time to time, without the consent of the Bondholders, create and issue further debentures, debenture stock, bonds, loan notes, or any other debt securities, either having the same terms and conditions as any outstanding debt securities of any series (including the Secured Callable Bonds) and so that such further issue shall be consolidated and form a single series with the outstanding debt securities of the relevant series (including the Secured Callable Bonds), or upon such terms as the Issuer may determine at the time of their issue, provided that no issue breaches the covenants agreed with the security trustee and Centris II may not be put up as Security.

10. Meetings of Bondholders

The Terms and Conditions of the Secured Callable Bonds may, subject to the prior written approval of the Exchange until such time that the Bonds remain admitted on any of its markets, be amended or waived with the approval of the Bondholders at a meeting called for that purpose by the Issuer through the Security Trustee.

11. Governing Law and Jurisdiction

The Secured Callable Bonds have been created, and the Bond Issue relating thereto is being made, in terms of the Act. The Secured Callable Bonds, and all contractual arrangements arising therefrom, shall be governed by and shall be construed in accordance with Maltese law. Any legal action, suit or proceedings against the Issuer and/or the Guarantor arising out of or in connection with the Secured Callable Bonds and/or the Company Admission Document shall be brought exclusively before Maltese courts and the Bondholder shall be deemed to acknowledge that it is submitting to the exclusive jurisdiction of such courts.

12. Sinking Fund

The Issuer undertakes that as from the financial year ending 2025 it will, over a period of 4 years, build a Sinking Fund the value of which will by the Redemption Date be equivalent to 50% of the value of the issued Bonds.

The Issuer shall make periodic payments for the purpose of building up the Sinking Fund. The below table sets out the minimum amounts to be paid by the Issuer for this purpose:

The company will contribute an annual amount of €750k between 2025 and 2028. Therefore, by the end of FY2029 the company would have contributed a total of €3million.

The Sinking Fund shall have the Issuer as primary beneficiary, whereas the Security Trustee, in its capacity as trustee of the KA Trust, shall be identified as a secondary beneficiary. Upon the occurrence of any of the Events of Default, the secondary beneficiary shall be granted priority rights over the Sinking Fund.

Sinking fund contribution as at:

| €000 | 2025 | 2026 | 2027 | 2028 | 2029 |
|----------------------------|------|------|------|------|------|
| <i>Annual contribution</i> | 750 | 750 | 750 | 750 | 0 |
| <i>Cumulative balance</i> | 750 | 1500 | 2250 | 3000 | 3000 |

KA Finance p.l.c. shall ensure that the sinking fund shall remain separate from the other assets of the company and shall ensure that these are held in term deposits placed with the major retail commercial banks in Malta.

13. Security Trust

The Secured Callable Bonds are secured, and Bondholders shall have the benefit of the following Security:

- (a) the Special Hypothec
- (b) the General Hypothec
- (c) Guarantee
- (d) The Pledge

The Security shall be constituted in favour of the Security Trustee for the benefit of all Bondholders from time to time registered in the CSD.

The Issuer and the Guarantor have entered into a Security Trust Deed with the Security Trustee which consists of the covenants of the Issuer and the Guarantor to pay the principal amount under the Secured Callable Bonds on the Redemption Date and interest thereon in terms of the Company Admission Document and the Guarantee and all the rights and benefits under the Security Trust Deed. The Collateral will be vested in the Security Trustee for the benefit of the Bondholders in proportion to their respective holding of Secured Callable Bonds.

The Security Trustee's role includes:

- (i) Acting as a Pledgee and thus receiving all funds from the Bond Issue and holding them with the Placement Agent until the Centris II property is transferred from PTL to KAH and until the Collateral is constituted to the Security Trustee in favour of the Bondholders.
- (ii) Holding of the Collateral for the benefit of the Bondholders and the enforcement of the said Collateral upon the occurrence of certain events. The Security Trustee shall have no payment obligations to Bondholders under the Secured Callable Bonds which remain exclusively the obligations of the Issuer, or, in the case of default by the Issuer, of the Guarantor.

The Issuer and Guarantor have agreed to grant the Collateral for the benefit of the Bondholders as beneficiaries, in terms of the Trust Deed constituting the KA Trust;

The Issuer, the Guarantor, the Pledgee and the Manager have entered into a Pledge Agreement to ensure the Collateral is constituted in favour other Security Trustee.

The collateral shall include the following:

- i. A Special Hypothec on an immovable property being Centris II, in Triq il-Palazz I-Ahmar, Mriehel, valued at €6.7 million (€6,700,000) as per Valuation in Annex A;
- ii. A General Hypothec on all of the Guarantor's present and future assets;
- iii. The joint and several suretyship by the Guarantor;
- iv. The Pledge.

Without prejudice to other powers and discretions of the Security Trustee in terms of the KA Trust, the Security Trustee shall have the discretion to enforce the Collateral on its own accord or upon receiving notice from the Bondholders and/or of the Corporate Advisor appointed under the Prospects MTF Rules and acting in its duty of care to the Exchange, the market and the Bondholders,

that any of the Events of Default has occurred in accordance with the provisions of the Company Admission Document.

14. Issue Fees

Save for the subscription for Secured Callable Bonds by any authorised financial intermediaries (which include the Placement Agent and Manager) and any fees payable to Curmi & Partners Limited as Placement Agent and Manager in connection with the Bond Issue, to the best of the Issuer's knowledge no person involved in the Issue has an interest material to the Bond Issue.

Professional fees and costs related to, printing, registration, selling commission and other miscellaneous costs incurred in connection with this Bond Issue are estimated not to exceed €120,000 and shall be borne by the Issuer.

15. Subscription

The Issuer has entered into a conditional subscription agreement with Curmi & Partners Ltd, the Placement Agent and Manager, for the subscription of the Secured Callable Bonds, whereby it will bind itself to allocate Secured Callable Bonds thereto up to the total amount of €6 million, subject to the Secured Callable Bonds being admitted to trading on the Prospects MTF. Applications for subscriptions to the Bonds will be processed on a first-come-first-served basis and the Issue Period shall close immediately upon attaining full subscription or on the last day of the Issue Period, whichever is the earliest.

The Bonds are open for subscription to all categories of investors, provided that the Placement Agent and Manager, and any other authorised financial intermediaries, shall be required to carry out an Appropriateness Test in respect of each Applicant for the purpose of assessing such Applicant's level of knowledge and experience prior to investing in the Bonds. Applications shall not be accepted by the Placement Agent and Manager or any other authorised financial intermediaries unless, based on the results of such Appropriateness Test, the Placement Agent and Manager or any other authorised financial intermediary is satisfied that an investment in the Bonds may be considered appropriate for the Applicant. To the extent that the Placement Agent and Manager or any other authorised financial intermediary is providing advice in respect of a purchase of the Bonds by an Applicant, the Placement Agent and Manager or any other authorised financial intermediary shall also be required to conduct a Suitability Test in respect of the Applicant and, based on the results of such test, be satisfied that an investment in the Bonds may be considered suitable for the Applicant. Prospective investors should be aware of the potential risks in investing in the Bonds after careful evaluation of all the risk factors involved, and should consider making the decision to invest after consideration with his/her own independent financial advisor. Authorised financial intermediaries subscribing for Bonds may do so for their own account or for the account of underlying customers, including retail customers, and shall, in addition, be entitled to distribute any portion of the Secured Callable Bonds subscribed for upon commencement of trading. In any case the Placement Agent and Manager shall ensure that subscribers to the Bonds

are duly warned about the Risk Factors involved with investing in the Bonds and subscribers shall confirm that they have been so warned.

The Bond Issue is not underwritten. Should subscriptions for a total of at least €4,000,000 (the "Minimum Amount") not be received, no allotment of the Bonds shall be made, the Applications for Bonds shall be deemed not to have been accepted by the Issuer and all money received from Applicants for Bonds shall be refunded accordingly. In the event that the Minimum Amount is reached but the Bond Issue is still not fully subscribed, the Issuer will proceed with the allotment of the amount of Bonds subscribed.

In terms of said subscription agreement entered into with the Placement Agent and Manager, the Issuer will be conditionally bound to issue, and the Placement Agent and Manager will be conditionally bound to subscribe to, up to the total amount of six million Euro (€6,000,000) of Bonds as indicated therein, each subject to the Minimum Amount of €4,000,000 being subscribed.

The total amount of six million Euro (€6,000,000) of Bonds is being reserved for subscription by the Placement Agent and Manager participating in the Placement Offer. The Issuer shall enter into a conditional subscription agreement with the Placement Agent and Manager for the subscription of Bonds, whereby it will bind itself to allocate Bonds thereto up to the total amount of six million Euro (€6,000,000) as aforesaid.

In terms of said subscription agreement entered into with the Placement Agent and Manager, the Issuer will be conditionally bound to issue, and the Placement Agent and Manager will be conditionally bound to subscribe to, up to the total amount of six million Euro (€6,000,000) of Bonds as indicated therein, each subject to the Minimum Amount of €4,000,000 being subscribed.

For the purpose of this Company Admission Document, the term "Suitability Test" means the process through which a licensed financial intermediary providing investment advice or portfolio management services in relation to the subscription for and trading of Bonds, obtains such information from the Applicant or prospective transferee, as is necessary, to enable the licensed financial intermediary to recommend to or, in the case of portfolio management, to effect for, the Applicant or prospective transferee, the investment service and trading in Bonds that are considered suitable for him/her, in accordance with Part BI of the Investment Services Rules for Investment Services Providers issued by MFSA. The information obtained pursuant to this test must be such as to enable the licensed financial intermediary to understand the essential facts about the Applicant or prospective transferee and to have a reasonable basis for believing, giving due consideration to the nature and extent of the service provided, that the specific transaction to be recommended, or to be entered into in the course of providing a portfolio management service, satisfies the following criteria:

- it meets the investment objectives of the Applicant or prospective transferee in question;
- it is such that the Applicant or prospective transferee is able financially to bear any related investment risks consistent with the investment objectives of such Applicant or prospective transferee; and
- it is such that the Applicant or prospective transferee has the necessary experience and knowledge in order to understand the risks involved in the transaction or in the management of his portfolio.

Expected Timetable

| | |
|--|--|
| 1. Application Forms available | 24 th July 2019 |
| 2. Issue Period | 24 th July to 7 th August 2019 |
| 3. Issuance of Bonds | 9 th August 2019 |
| 4. Commencement of interest on Bonds | 9 th August 2019 |
| 5. Expected date of Constitution of Security | 12 th August 2019 |
| 7. Expected date of admission of the Bonds to Prospects MTF List | 14 th August 2019 |
| 8. Expected date of commencement of trading in the Bonds | 16 th August 2019 |

The Issuer reserves the right to close the offer of the Bonds before the 7th August 2019 at 12:00 CET in the event that the Bonds are fully subscribed prior to the said date and time. In such an eventuality, the events set out in steps three (3) to eight (8) above shall be brought forward although the number of working days between the respective events shall not also be altered.

3 Risk factors

THE VALUE OF INVESTMENTS CAN GO UP OR DOWN AND PAST PERFORMANCE IS NOT NECESSARILY INDICATIVE OF FUTURE PERFORMANCE.

THE NOMINAL VALUE OF THE BONDS WILL BE REPAYABLE IN FULL UPON MATURITY ON THE REDEMPTION DATE UNLESS THE BONDS ARE PREVIOUSLY REPURCHASED AND CANCELLED, OR UNLESS THE BONDS ARE OTHERWISE PREVIOUSLY REDEEMED AT THE OPTION OF THE ISSUER ON ANY OF THE EARLY REDEMPTION DATES AS DESCRIBED IN SECTION T 3.5.1 AND AS OUTLINED BY THE EARLY REDEMPTION SCHEDULE BY THE ISSUER GIVING NOT LESS THAN 60 DAYS' NOTICE IN WRITING TO BONDHOLDERS.

AN INVESTMENT IN THE SECURED CALLABLE BONDS INVOLVES CERTAIN RISKS INCLUDING THOSE DESCRIBED BELOW. PROSPECTIVE INVESTORS SHOULD CAREFULLY CONSIDER WITH THEIR OWN INDEPENDENT FINANCIAL AND OTHER PROFESSIONAL ADVISORS, THE FOLLOWING RISK FACTORS AND OTHER INVESTMENT CONSIDERATIONS AS WELL AS ALL THE OTHER INFORMATION CONTAINED IN THIS COMPANY ADMISSION DOCUMENT, BEFORE DECIDING TO MAKE ANY INVESTMENT DECISION WITH RESPECT TO THE ISSUER AND/OR THE GUARANTOR. SOME OF THESE RISKS ARE SUBJECT TO CONTINGENCIES WHICH MAY OR MAY NOT OCCUR AND NEITHER THE ISSUER NOR THE GUARANTOR ARE IN A POSITION TO EXPRESS A VIEW ON THE LIKELIHOOD OF ANY SUCH CONTINGENCIES OCCURRING. THE SEQUENCE IN WHICH THE RISKS BELOW ARE LISTED IS NOT INTENDED TO BE INDICATIVE OF ANY ORDER OF PRIORITY OR OF THE EXTENT OF THEIR CONSEQUENCES.

THE BONDS ARE COMPLEX FINANCIAL INSTRUMENTS AND MAY NOT BE SUITABLE FOR ALL TYPES OF RETAIL INVESTORS. A POTENTIAL INVESTOR SHOULD NOT INVEST IN THE BONDS UNLESS: I) HE/SHE HAS THE NECESSARY KNOWLEDGE AND EXPERIENCE TO UNDERSTAND THE RISKS RELATING TO THIS TYPE OF FINANCIAL INSTRUMENT; II) THE BONDS MEET THE INVESTMENT OBJECTIVES OF THE POTENTIAL INVESTOR; AND III) SUCH POTENTIAL INVESTOR IS ABLE TO BEAR THE INVESTMENT AND FINANCIAL RISKS WHICH RESULT FROM INVESTMENT IN THESE BONDS.

IF ANY OF THE RISKS DESCRIBED BELOW WERE TO MATERIALISE, THEY COULD HAVE A SERIOUS EFFECT ON THE ISSUER'S AND/OR GUARANTOR'S FINANCIAL RESULTS AND TRADING PROSPECTS AND THE ABILITY OF THE ISSUER AND/OR GUARANTOR TO FULFILL THEIR RESPECTIVE OBLIGATIONS UNDER THE SECURITIES ISSUED BY THE ISSUER FROM TIME TO TIME. THE RISKS AND UNCERTAINTIES DISCUSSED BELOW ARE THOSE IDENTIFIED AS SUCH BY THE DIRECTORS OF THE ISSUER AND THE GUARANTOR AS AT THE DATE OF THE COMPANY ADMISSION DOCUMENT, BUT THESE RISKS AND UNCERTAINTIES MAY NOT BE THE ONLY ONES THAT THE ISSUER AND GUARANTOR MAY FACE. ADDITIONAL RISKS AND UNCERTAINTIES, INCLUDING THOSE WHICH THE ISSUER'S AND/OR GUARANTOR'S DIRECTORS ARE NOT CURRENTLY AWARE OF, MAY WELL

RESULT IN A MATERIAL IMPACT ON THE FINANCIAL CONDITION AND OPERATIONAL PERFORMANCE OF THE ISSUER AND/OR GUARANTOR.

NEITHER THIS COMPANY ADMISSION DOCUMENT NOR ANY OTHER INFORMATION SUPPLIED HEREIN IN CONNECTION WITH THE SECURED CALLABLE BONDS ISSUED BY THE ISSUER (I) IS INTENDED TO PROVIDE THE BASIS OF ANY CREDIT OR OTHER EVALUATION, NOR (II) SHOULD BE CONSIDERED AS A RECOMMENDATION BY THE ISSUER OR THE GUARANTOR OR THE CORPORATE ADVISOR OR THE PLACEMENT AGENT AND MANAGER OR AUTHORISED INTERMEDIARY THAT ANY RECIPIENT OF THE COMPANY ADMISSION DOCUMENT, OR ANY OTHER INFORMATION SUPPLIED IN CONNECTION THEREWITH, SHOULD PURCHASE ANY SECURITIES ISSUED BY THE ISSUER. PROSPECTIVE INVESTORS SHOULD MAKE THEIR OWN INDEPENDENT EVALUATION OF ALL RISK FACTORS AND SHOULD CONSIDER ALL OTHER SECTIONS IN THIS DOCUMENT.

3.1 Forward-looking statements

The Company Admission Document and the documents incorporated therein by reference or annexed thereto contain forward-looking statements that include, among others, statements concerning the Issuer's and/or Guarantor's strategies and plans relating to the attainment of its objectives, capital requirements and other statements of expectations, beliefs, future plans and strategies, anticipated developments and other matters that are not historical facts and which may, accordingly, involve predictions of future circumstances. Prospective investors can generally identify forward-looking statements by the use of terminology such as "may", "will", "expect", "intend", "plan", "estimate", "forecast", "anticipate", "believe" or similar phrases. Such forward-looking statements are inherently subject to a number of risks, uncertainties and assumptions, a few of which are beyond the Issuer's and/or Guarantor's control.

Important factors that could cause actual results to differ materially from the expectations of the Issuer's and/or Guarantor's directors include those risks identified under this heading "Risk Factors" and elsewhere in the Company Admission Document. If any of the risks described were to materialise, they could have a material adverse effect on the Issuer's and/or Guarantor's financial results, trading prospects and the ability of the Issuer and/or Guarantor to fulfil their respective obligations under the securities to be issued in terms of the Company Admission Document.

Accordingly, the Issuer and/or Guarantor caution prospective investors that these forward-looking statements are subject to risks and uncertainties that could cause actual events or results to differ materially from those expressed or implied by such statements, that such statements do not bind the Issuer and/or Guarantor with respect to future results and no assurance is given that the projected future results or expectations covered by such forward-looking statements will be achieved.

Prospective investors are advised to read the Company Admission Document in its entirety and, in particular, the sections entitled “Risk Factors” for a further discussion of the factors that could affect the Issuer’s and/or Guarantor’s future performance. In the light of these risks, uncertainties and assumptions, the events described in the forward-looking statements in the Company Admission Document may not occur. All forward-looking statements contained in the Company Admission Document are made only as at the date hereof.

The value of investments can go up or down and past performance is not necessarily indicative of future performance. The nominal value of the Secured Callable Bonds will be repayable in full upon maturity, unless the Secured Callable Bonds are previously re-purchased and/or cancelled, or in the case of an early redemption as outlined in the Early Redemption Schedule. An investment in the Secured Callable Bonds involves certain risks, including those described below.

3.2 Suitability of Investment

The Bonds are complex financial instruments and may not be suitable for all recipients of the Company Admission Document. Prospective investors are urged to consult an independent investment advisor licensed under the Investment Services Act (Cap. 370 of the laws of Malta) as to the suitability or otherwise of an investment in the Bonds before making an investment decision. In particular, such advice should be sought with a view to ascertaining that each prospective investor:

- a. has sufficient knowledge and experience to make a meaningful evaluation of the Bonds, the merits and risks of investing in the Bonds and the information contained or incorporated by reference to the Company Admission Document or any applicable supplement;
- b. has sufficient financial resources and liquidity to bear all the risks of an investment in the Bonds, including where the currency for principal or interest payments is different from the prospective investor’s currency;
- c. understands thoroughly the terms of the Bonds and is familiar with the behaviour of any relevant indices and financial markets; and
- d. is able to evaluate possible scenarios for economic, interest rate and other factors that may affect its investment and its ability to bear the applicable risks.

3.3 Risks relating specifically to the Issuer

3.3.1 Risks relating specifically to the Issuer’s reliance on the Guarantor

The Issuer was established on 22nd April 2019 and, accordingly, has no trading record or history of operations. Furthermore, the Issuer itself does not have any substantial assets and is essentially a

special purpose vehicle set up to act as a financing company solely for the needs of the Group and, as such, its assets are intended to consist primarily of a loan issued to the Guarantor.

The Issuer is dependent on the business prospects of the Group and, consequently, the operating results of the Group have a direct effect on the Issuer's financial position. Therefore, the risks intrinsic in the business and operations of the Group companies have a direct effect on the ability of the Issuer and the Guarantor to meet their respective obligations in connection with the payment of Interest on the Secured Callable Bonds and repayment of principal when due. Accordingly, the risks of the Issuer are indirectly those of the Group (Guarantor) and, in turn, all risks relating to the Group are the risks relevant to the Guarantor.

Specifically, the Issuer is principally dependent, including for the purpose of servicing the Interest payments on the Secured Callable Bonds and the repayment of the principal amount on Redemption Date, or of the principal amount plus premium (as outlined in the Early Redemption Schedule) on any of the Early Redemption Dates, on the receipt of interest payments and loan repayments from the Guarantor.

The interest payments and loan repayments to be affected by the Guarantor are subject to certain risks. More specifically, the ability of the Guarantor to effect payments to the Issuer will depend on the cash flows and earnings of the Guarantor, which may be restricted by changes in applicable laws and regulations; by the terms of agreements to which they are or may become party; or by other factors beyond the control of the Issuer and/or Guarantor. The occurrence of any such factor could, in turn, negatively affect the ability of the Issuer and the Guarantor to meet their respective obligations in connection with the payment of Interest on the Secured Callable Bonds and repayment of principal when due.

3.4 Risks related to the Group and its business

3.4.1 Single shareholder

The parent company of the Group is owned by Kurt Abela (99.999%) and Project Teknik LTD (0.001%), a company exclusively owned by Kurt Abela. Accordingly, the ultimate owner of both the Issuer and Guarantor, is also the Managing Director of the Issuer and the Guarantor and exercises effective control over the Issuer. Kurt Abela is considered instrumental to the Group and the Issuer and any unexpected dilution, whether by sale and/or transfer of any of his interest in the Group, or by way of transmission, in his control or influence over the Issuer and/or the Group companies and their business could have an adverse effect on the Issuer. There can be no assurance that such individual will not at any time during the term of the Bonds dispose of any interest, direct or indirect, in the Issuer or the Group.

3.4.2 Potential exposure to certain financial risks

The Issuer's activities are potentially exposed to a variety of financial risks, including interest rate risk. The Issuer may be exposed to the risks associated with the effects of fluctuations in the prevailing levels of market interest rates on its financing position and cash flows.

3.4.3 Risks inherent in forecasts

This Company Admission Document features projected revenues of KA Holdings. Forecasts are inherently subject to the risks of adverse unexpected events which may affect the revenue streams and profitability of KA Holdings. The forecasts set out in this Company Admission Document are dependent on a number of assumptions and future expectations that may or may not occur. The non-occurrence of those future expectations could have material effects on the financial position and results of the Guarantor and hence the Issuer. The said forecasts are therefore merely an illustration of a possible future outcome which may or may not occur and the Issuer, its directors, officers and advisers make no representation as to their accuracy or likelihood of occurrence.

3.4.4 Business Risks

Given the Issuer's recent incorporation, it does not itself have any trading history. The Guarantor has a trading history in building Centris I in Mriehel and having all office space in this building rented out. The business model remains primarily reliant on offering its customers high-quality office space at competitive renting rates in the same location of Mriehel. In addition, KA Holdings shall also diversify its business by operating luxury apartments in Swieqi for short lets and a boutique hotel in Gzira. Consequently, the KA Holdings is dependent on the office space rental market and the hospitality industry in Malta. Accordingly, the Group's prospects should be considered in the light of the risks and difficulties encountered by companies operating in similar markets and industry sectors in Malta.

3.4.5 Risks relating to the political, economic and social environment in which KA Holdings operates

The Group's assets and operations are all situated in Malta. Accordingly, the Group is generally exposed to the economic and political conditions which are prevalent in Malta from time to time, thereby rendering the Group's operations overly exposed to the social, political and economic stability in Malta, which, in the event of downward trend could have a material adverse impact on the operations of the Group. Such over-exposure to the Maltese market could render investment in the Group riskier than investments in more geographically diversified operations.

Consequently, the Group is highly susceptible to the economic trends that may from time to time be felt in Malta and internationally, including fluctuations in consumer demand, financial market volatility, inflation, fall in value of the property market in Malta, reduction in economic growth in Malta leading to less office space being required, interest rates, exchange rates, direct and indirect taxation, wage rates, utility costs, government spending and budget priorities and other general

market, economic and social factors. Any future expansion of the Group's operations into other markets would further increase its susceptibility to adverse economic developments and trends affecting such other markets.

Negative economic factors impacting both local and foreign markets, could have a material impact on the business of the Group generally, and may adversely affect revenues and results of operations and the ability of the Issuer to meet its obligations under the Bonds.

3.4.6 The Group's dependence on its Managing Director and other skilled personnel

The Group's growth since inception is, in part, attributable to the efforts and abilities of the Managing Director. The Group's future success will also depend, among other things, on its future directors and management. If the Managing Director is unable or unwilling to continue in his present position, he may not be replaceable within the short term, which could have an adverse effect on the Group's business, financial condition and results of operations. Consequently, there is no guarantee that these objectives will be achieved to the degree expected should the Managing Director no longer continue in his present role.

The ability to compete effectively in the markets in which the Group operates depends upon the ability to identify, hire, train, motivate and retain personnel and skilled employees, particularly in the areas of commercial property, financial management, project management and operating a boutique hotel. The market for qualified personnel is competitive and the Group may not succeed in attracting, developing and retaining the right calibre of staff in line with the rapid growth of its business, or it may fail to effectively replace personnel who depart with qualified or effective successors. The failure of the Group to recruit and retain personnel and skilled specialist employees who can understand the value chain and provide the required expertise across the entire spectrum of the Group's operations, or to integrate new talent to supplement the existing team could adversely impact its sales performance, increase its wage costs, and adversely affect the Group's business, results of operations and financial condition.

3.4.7 Reliance on non-proprietary software systems and third-party IT providers

To varying degrees, the Group is reliant upon technologies and operating systems (including IT systems) developed by third parties for the running of its business and are exposed to the risk of failures in such systems. Whilst the Group has service level agreements and disaster recovery plans to ensure continuity and stability of these systems, there can be no assurance that the service or systems will not be disrupted. Disruption to those technologies or systems and/or lack of resilience in operational availability could adversely affect the efficiency of the Group's business, financial condition and/or operating results.

3.4.8 Failure to protect customers' confidential information could impact the Group's reputation and expose it to litigation

The Group must comply with restrictions on the use of customer data and ensure that confidential information (including financial and personal data) is transmitted in a secure manner over public networks. Despite controls to ensure the confidentiality, availability and integrity of customer data, the Group may inadvertently breach restrictions or may be subject to attack from computer programs that attempt to penetrate the network security and misappropriate confidential information. Due to advances in these programs, computing capabilities and other developments, there is no guarantee that the Group's security measures will be sufficient to prevent breaches. Any such breach or compromise of security could adversely impact the Group's reputation with current and potential customers, lead to litigation or fines, and as a result, have a material adverse effect on its business, results of operations and overall financial condition.

3.4.9 Regulation regarding the use of personal customer data

The Group will process sensitive personal customer data (including possibly name, address, age, bank details and identification details) as part of its business and therefore will be required to comply with strict data protection and privacy laws and other regulatory restrictions, including industry standards and limitations. Such laws will restrict the ability of the Group to collect and use personal information including the marketing use of that information. The Group relies on third-party contractors and employees to maintain databases and seek to ensure that procedures are in place to comply with the relevant data protection regulations. Notwithstanding such efforts, the Group is exposed to the risk that this data could be wrongfully appropriated, lost or disclosed, or processed in breach of data protection regulations, by or on behalf of the Group. If the Group, or any of the third-party service providers on which the Group relies, fails to transmit customer information and online payment details in a secure manner, or if any such loss of personal customer data were otherwise to occur, the Group could face liability under data protection laws. This could also result in the loss of the goodwill of customers and deter new customers from the Group's products which would have a material adverse effect on the Group's businesses, financial condition and results of operations.

The Group's failure to comply with, privacy, data use and security laws, standards and regulations could result in the limitation, suspension or termination of services or the imposition of administrative, civil or criminal penalties, including fines which may result after the General Data Protection Regulation (GDPR) became applicable in May 2018. In addition, such failure or non-compliance may cause existing or potential customers to be reluctant to do business with the Group, and could damage the Group's reputation and brand. Customer and regulator attitudes towards privacy and data protection are evolving, and there could be adverse changes or developments in customer or regulatory concerns regarding the extent to which business and personal information and data are stored, processed or shared with advertisers or other third parties. In addition, to the extent more restrictive laws, rules or industry security requirements relating to business and personal information and data are adopted in the future or by specific industry bodies, such changes could have an adverse impact on the Group by increasing its costs

or imposing restrictions on its business processes. Accordingly, the Group's failure to keep apprised of, and comply with, privacy, data use and security laws, standards and regulations, and any adverse changes or developments regarding user or regulatory concerns towards privacy and data protection or otherwise in the regulatory or legal landscape could have a material adverse effect on the Group's reputation, business, financial condition, results of operations and prospects. The Group's financial exposure to any actual or alleged breach of such regulations or standards may either not be insured against or not fully covered through any insurance maintained by the Group.

Furthermore, although a number of basic existing principles will remain the same, the GDPR introduces new obligations on data controllers and rights for data subjects, including, among others:

- accountability and transparency requirements, which will require data controllers to demonstrate and record compliance with the GDPR and to provide more detailed information to data subjects regarding processing;
- enhanced data consent requirements, which includes "explicit" consent in relation to the processing of sensitive data;
- obligations to consider data privacy as any new products or services are developed and limit the amount of information collected, processed, stored and its accessibility;
- limitation on using data to profile data subjects;
- providing data subjects with personal data in a useable format on request and erasing personal data in various circumstances; and
- reporting of breaches without undue delay, at times within 72 hours.

The GDPR also introduces new fines and penalties for a breach of requirements, including fines for serious breaches of up to the higher of 4% of annual worldwide turnover or €20m and fines of up to the higher of 2% of annual worldwide turnover or €10m (whichever is highest) for other specified infringements.

The implementation of the GDPR may require amendments to the Group's procedures and policies. The changes could adversely impact the Group's business by increasing its operational and compliance costs. Further, there is a risk that the measures will not be implemented correctly or that individuals within the business will not be fully compliant with the new procedures. If there are breaches of these measures, the Group could face significant administrative and monetary sanctions as well as reputational damage, as pointed out above, which may have a material adverse effect on its operations, financial condition and prospects.

3.4.10 Risk of litigation

Since KA Holdings operates in industries which involve the continuous provision of services to customers and such operations necessarily require continuous interaction with suppliers, employees, lessors and regulatory authorities, the Group is exposed to the risk of litigation from its customers, actual and potential partners, suppliers, employees, regulatory authorities and/or lessors. Consequently, the Group is subject to legal claims, with or without merit. Defence and settlement costs can be substantial, even with respect to claims that have no merit. Due to the inherent uncertainty of the litigation and dispute resolution process, there can be no assurance that the resolution of any particular legal proceeding or dispute will not have a material adverse effect on KA Holding's future cash flow, results of operations or financial condition.

3.4.11 The Group's insurance policies

The Group shall seek to take out an insurance policy covering accidental damage to property and an all risks insurance policy in respect of its most important assets. However, the Group cannot guarantee that cost incurred as a result of any natural disaster or other unforeseeable events (such as fire, flood, deluge, windstorm, hailstorm, etc.) would not have an adverse effect on its assets and/or economic and financial situation, as the Group's insurance does not fully cover any and all risks associated with assets owned by the Issuer.

There is the risk that the existing insurance coverage is not sufficient. In particular there is the risk that failures and losses arise exceeding the extent of the existing insurance coverage. In addition to this there is the risk that there is no adequate insurance coverage available for certain risks, or at least not available under proper conditions. If a loss against which there is no or only inadequate insurance coverage, should be inflicted on the Issuer and/or the Guarantor, such loss can have an adverse effect on the financial situation, status and results of the Guarantor and/or the Issuer.

3.4.12 Leveraged capital structure

The Group's capital structure is leveraged, especially in the initial years, which gives rise to all the risks typically associated with such leveraged capital structures. Gearing is then projected to decrease as the retained earnings levels improve the shareholder equity base and as borrowings decrease over time. However, there is the risk that the debt service obligations resulting from such a capital structure will absorb a significant portion of cash generation. Should the Group not manage to achieve its projected operating results, this will adversely impact gearing levels. Adverse changes to the Group's projected cash flows will reduce the projected level of debt service cover and may, therefore, adversely affect its ability to meet its debt service obligations.

3.4.13 KA Holding's indebtedness could adversely affect its financial position

KA Holdings has a material amount of debt and may incur additional debt in connection with its future growth. A portion of the cash flow generated from the Group's operations is utilised to repay debt obligations. This gives rise to a reduction in the amount of cash available for funding the

working capital, capital expenditure, development costs or other general corporate costs. A decrease in operating cash flow may limit further available cash for working capital purposes and other purposes, which may have an adverse material effect on the financial condition and results of KA Holdings.

In addition, the agreements regulating the KA Holding's bank debt impose guarantees and hypothecs on the KA Holdings and some of its assets. In relation to new indebtedness banks may impose operating restrictions and financial covenants on KA Holdings which could limit the company's ability to obtain future financing, to make capital expenditure, to withstand a future downturn in business or economic conditions generally or could otherwise inhibit the ability of the company to conduct necessary corporate activities.

3.4.14 Financing strategy

The Group may not be able to secure sufficient financing for its current and future investments. No assurance can be given that sufficient financing will be available on commercially reasonable terms or within the timeframes required by the Group, also taking into account the need from time to time for the Group's office space, luxury apartments and boutique hotel to undergo renovation, refurbishment or other improvements in the future. A decline in the capacity or willingness of banks to provide funding or any weakness in the capital markets may limit the Group's ability to raise capital for completion of projects that have commenced or for development of future properties. Failure to obtain, or delays in obtaining, the capital required to complete current or future developments and investments on commercially reasonable terms, including increases in borrowing costs or decreases in loan availability, may limit the Group's growth and materially and adversely affect its business, financial condition, results of operations and prospects.

3.4.15 Exposure to certain financial risks, including interest rate risk

The Guarantor's activities potentially expose it to a variety of financial risks, including market risk (principally interest rate risk and fair value risk), credit risk and risks associated with the unpredictability of financial markets, all of which could have adverse effects on its financial performance.

Interest rate risk refers to the potential changes in the value of financial assets and liabilities in response to changes in the level of interest rates and their impact on cash flows. The Group may be exposed to the risks associated with the effects of fluctuations in the prevailing levels of the market interest rates on its financial position and cash flows.

3.4.16 Changes to laws and regulation

The Group is subject to a variety of laws and regulations, including taxation, environmental, planning and health and safety regulations. The Group is at risk in relation to changes in the laws and regulations and the timing and effects of changes in the laws and regulations to which it is subject, including changes to the interpretation thereof, which cannot be predicted. No assurance

can be given as to the impact of any possible judicial decision, change in law, regulation or administrative practice, after the date of this Company Admission Document, on the business and operations of the Group.

3.4.17 Risks relating to taxation

The amount of taxation charged on the KA Holding's activities is subject to changes in tax laws and their practical application.

3.4.18 Risks relating to the Commercial property

3.4.18.1 Property Valuations

The valuation of property and property-related assets is inherently subjective. All relevant valuations have been done by independent architects and are being included in this Admission Document with such architects' consent, and such consent has not been withdrawn. The valuation of Centris II, in particular, which still has to be built, is more subjective in nature, since it is at an early stage of development. There can be no assurance that such valuation of development will reflect actual market values of the finished and commissioned building.

When estimating a property's market value, the independent architects made certain assumptions. Actual values may be materially different from any values that may be expressed or implied on the basis of such assumptions and forward-looking statements may not match reality. There can be no assurances that such valuations will reflect actual market values.

3.4.18.2 Property market trends

KA Holdings shall be developing the various outlined properties through building, refurbishment and finishing off of the mentioned properties. Therefore, the Group is exposed to fluctuations in the property and real estate markets. There are several factors that commonly affect the real estate market generally, many of which are beyond the control of KA Holdings, and which could adversely affect the economic performance and value of any property under development. Such factors include:

- changes in general economic conditions;
- general industry trends, including the cyclical nature of the real estate market;
- changes in local market conditions, such as over-supply of similar properties, a reduction in demand for real estate or change of local preferences and tastes;
- possible structural and environmental problems;
- acts of nature, such as earthquakes and floods, that may damage the property or delay its development;

- increase in competition in the market segment in which KA Holdings is undertaking property market development may lead to an over-supply of office space for rental, which could lead to a lowering of prices and a corresponding reduction in revenue;
- political developments;
- introduction or changes to regulation, policy or tax law;
- interest rate fluctuations;
- inflation; and
- the availability or otherwise of financing and alternative yields of investment.

Any of the factors described above could have a material adverse effect on the Group's business, its financial condition and prospects and accordingly on the repayment of the Secured Callable Bonds and interest thereon.

3.4.18.3 Development risk

KA Holdings may be subject to risks associated with the development of the real estate, including the risk relating to project financing, planning permits, delays, cost over-run, risk of insufficiency of resources, risk of licensing transactions not being effected at the prices and timeframes envisaged, higher interest costs, erosion of revenue generation, risk of suspension of works from any applicable authority or administrative body, and the possibility of legal disputes. If these risks were to materialise, they could have an adverse and material effect on the Group's financial condition and the results of its operations.

In addition, for the timely completion of development projects, KA Holdings may place certain reliance on counterparties such as architects, engineers, contractors and sub-contractors, engaged in the demolition, excavation, construction and finishing of developments. Such counterparties may fail to perform or default on their obligations, whether due to insolvency, lack of liquidity, economic or market downturn, operational failure or other reasons, all of which are beyond KA Holding's control. Failure of such counterparties to perform their obligations could, in turn, materially adversely affect the financial condition of the Group and its future prospects. In addition, the inability of KA Holdings to develop and maintain relationships with highly skilled, competent and reliable counterparties could have a material adverse effect on the KA Holding's development projects.

3.4.18.4 Risks related to the Rental Market

KA Holdings is reliant on rental income streams, with the rental of office space being the major business. The property rental market in Malta, including both commercial and residential properties, is very competitive. Increases in supply of and declines in demand for commercial and residential property to be leased may put downward pressure on the leases which the Group will

be able to achieve, or make it challenging to even rent out the properties. This may have an adverse impact on the financial performance and condition of the Group.

3.4.18.5 Environmental and other regulatory liabilities

Laws and regulations, which may be amended from time to time, impose liability for the presence of certain materials or substances or the release of certain materials or substances into the air, land or water or the migration of certain materials or substances from a real estate development, including asbestos, and such presence, release or migration could form the basis for liability to third parties for personal injuries or other damages.

In view of these obligations, in connection with any prospective property development project, KA Holdings may become liable for the costs of removal, investigation or remediation of any such substances, including hazardous or toxic substances that may be located on or in, or which may have migrated from, a property owned or occupied by it, which costs may be substantial. The Group may also be required to remove or remediate any such substances or materials that it causes or knowingly permits at any property that it owns or may in the future own.

In addition to environmental constraints, any activity the Group undertakes to carry out in the property development sector in the future will be subject to extensive regulations, including national and local regulation and administrative requirements and policies which relate to, among other things, planning, developing, land use, local urban regeneration strategy, fire, health and safety, and others. These regulations often provide broad discretion to the relevant authorities and non-compliance may adversely affect KA Group.

3.4.18.6 Risk of injuries or fatalities in construction and damage to reputation

There are inherent risks to health and safety arising from the nature of property development, which accordingly require a developer to adopt and maintain a rigorous health and safety programme. A health and safety track record is critical to the success and reputation of the Group's prospective property development operations. Any failure in health and safety performance may result in penalties for non-compliance with the relevant regulatory requirements, and a failure which results in a major or significant health and safety incident, such as injury to, or fatality of, members of the construction workforce or bystanders, may be costly in terms of potential liabilities arising as a result, as well as the generation of adverse publicity having a negative impact on KA Holding's reputation.

3.4.18.7 Costs incurred when proposed property investment is aborted

KA Holdings may at times incur significant costs in connection with the assessment of potential property investment opportunities. These may involve costs associated with property surveys, valuation reports, title and environmental investigations. If a proposed real estate investment were not to proceed to completion after such costs have been incurred, KA Holdings will be unable to recoup same directly from that investment, which could have a negative impact on profitability.

3.4.19 Risks relating to the hospitality industry

3.4.19.1 No history in short letting of luxury apartments or operating a boutique hotel

As set out in Section 20.2 of this Company Admission Document, the proceeds of the Bond will partly be used to build and finish off luxury apartments. KA Holdings has no history in operating the short letting of luxury apartments and a boutique hotel and has therefore employed a general manager to run these activities. Consequently, should these mentioned operations be unprofitable, this could have a material adverse effect on the business of KA Holdings, the results of its operations and its financial condition.

3.4.19.2 General risks associated with the hospitality industry

The Group will be subject to a number of external factors that could adversely affect its business once the luxury apartments and the boutique hotel commence operations, many of which are common to the hospitality industry and beyond the Group's control, including the following:

- changes in travel patterns, any increase in or the imposition of new taxes on air travel and fuel, and cutbacks and stoppages on Malta-bound airline routes;
- changes in laws and regulations on employment, the preparation and sale of foods and beverages, health and safety, environmental concerns, fiscal policies, zoning and development, and the related costs of compliance;
- the impact of increased threats of terrorism or actual terrorist events, impediments to means of transportation (including airline strikes and border closures), extreme weather conditions, natural disasters, travel-related accidents, outbreaks of diseases and health concerns, or other factors that may affect travel patterns and reduce the number of business and leisure travellers; and
- increases in operating costs due to inflation, employment costs, workers' compensation and healthcare related costs, utility costs, increased taxes and insurance costs.

The impact of any of these factors (or a combination of them) may adversely impact room rates and occupancy levels or otherwise cause a reduction in revenue, which could have a material adverse effect on the Group's business, financial condition and results of operations.

Furthermore, the hospitality industry is subject to rapidly evolving consumer trends, the success of KA Holding's hospitality operations is dependent upon the priorities and preferences of customers, whether local or foreign, and its ability to swiftly anticipate, identify and capitalise upon emerging consumer trends. If KA Holdings is unable to do so, it could experience reduced rates and occupancy levels, which could have a material adverse effect on the Group's operational results.

The Group's hospitality operations are also susceptible to strong and increasing local and global competition, influenced by a variety of determining factors including accommodation rates, packages variety, quality, availability, reliability, after-sales service and logistics, and the

fluctuations in demand for private and shared accommodation alternatives. The level of competition is subject to increase, and such increase or even saturation in the supply of accommodation may negatively impact the Group's sales revenue and profitability in the hospitality sector.

In addition, many of KA Holding's current and potential competitors may have greater name recognition, a larger customer base and greater financial and other resources than the Group. In particular, KA Holding may be compelled, by the strength of its competitors that are able to supply accommodation and services at lower prices, to reduce its own prices. The ability of the Group to maintain or increase its profitability will be dependent on its ability to offset such decreases in the prices and margins of its accommodation and services.

3.4.19.3 Relations with suppliers

The Group's profitability of its hospitality activities depends in part on its ability to anticipate and react to changes in the cost of its supplies, and on its dependence on frequent, timely and high-quality deliveries by its suppliers. The Group may not be able to acquire suitable products in sufficient quantities and/or on terms acceptable to it in the future. Any deterioration or change in the Group's relationships with its suppliers (including supplying on less favourable terms) could have an adverse effect on the Group.

3.4.19.4 Complaints and litigious claims

In its operations of the short letting of the luxury apartments and the boutique hotel, KA Holdings may be subject to complaints or claims from customers alleging illnesses, injuries suffered on premises, or financial damage suffered by the level of service offered operated. Adverse publicity from such allegations may materially affect sales revenue generated by KA Holdings hospitality establishments, regardless of whether such allegations are true or not.

In addition, other litigation, including but not limited to disputes with its employees based on claims of, amongst others, discrimination, harassment or wrongful termination, may divert financial and management resources that would otherwise be used to benefit the future performance of KA Holding's operations.

All litigation is expensive, time consuming and may divert management's attention away from the operation of the business. In addition, the Group cannot be certain that its insurance coverage will be sufficient to cover one or more substantial claims.

3.4.19.5 Regulatory compliance

The Group is subject to various laws and regulations affecting its business. The operation of short letting luxury apartments and a boutique hotel are both subject to licensing and regulation by a number of governmental authorities, which may include health and safety measures, disability access requirements and fire safety requirements. Difficulties in obtaining or maintaining the required licences or approvals, or the loss thereof, could adversely affect KA Holding's business and results of its operations. Various bodies also have the power to conduct inspections of, and possibly

close down, the mentioned hospitality establishments, if they fail to comply with the relevant laws and regulations. No assurance can be given that claims based on these laws will not be brought against KA Holdings in the future.

Malta Tourism Authority (MTA) licenses required are still to be applied for. There could be a delay in having these licences acquired, which would result in a delay in having the projected revenues materialised. There is also the risk of the MTA licence not being achieved at all, meaning that KAH would not be able to carry out its hospitality related business.

3.5 Risks specific to the Secured Callable Bonds

3.5.1 Early redemption

The Issuer has the option to redeem the Bonds, in whole, at any of the Early Redemption Dates in accordance with the provisions of Early Redemption Schedule as mentioned in Section 2.2.6 (sub section no.3) of this Company Admission Document, together with any unpaid interest until the time of redemption.

This optional redemption feature may have a negative impact on the market value of the Bonds. During a period when the Issuer may opt to redeem the Bonds, the market value may not rise considerably above the price at which the Bond will be redeemed.

Should the Issuer decide to redeem the Bonds on any of the Early Redemption Dates, the Bondholder may not be able to re-invest the proceeds from the redemption at yields that would have been received on the Bonds had they not been redeemed.

3.5.2 No Prior Public Market

Prior to the Bond Issue, there has been no public market nor trading record of the Secured Callable Bonds within or outside Malta. Due to the absence of any prior market for the Secured Callable Bonds, there can be no assurance that the Bond Issue Price will correspond to the price at which the Secured Callable Bonds will trade in the market subsequent to the Bond Issue

3.5.3 Lack of Market Liquidity

Upon successful admission, the Secured Callable Bonds may be traded on Prospects MTF but will NOT be traded on any regulated market. Hence, the market for these Secured Callable Bonds may be less liquid than a regulated market and a Bondholder may find it more difficult to identify willing buyers for their Secured Callable Bonds. The existence of an orderly and liquid market depends on a number of factors. Accordingly, there can be no assurance that an active secondary market for the Bonds will develop, or if it develops, that it will continue. Furthermore, there can be no assurance that an investor will be able to sell or otherwise trade in these Secured Callable Bonds at all.

3.5.4 Changes in Interest Rates

An Investment in the Secured Callable Bonds involves the risk that subsequent changes in market interest rates may adversely affect the value of the Secured Callable Bonds. Investment in such fixed rate Secured Callable Bonds involves the risk that subsequent changes in market interest rates may adversely affect the market value of the said Secured Callable Bonds. Investors should also be aware that the price of the fixed rate bonds moves adversely to changes in interest rates;

3.5.5 Suitability

Prospects MTF is a market regulated as a multilateral trading facility and operated by the MSE and provides a venue for SMEs to float their securities. Consequently, this market is designed primarily for companies to which a higher risk than that associated with established companies tends to be attached. A prospective investor should be aware of the potential risks in investing in such companies and should make the decision to invest only after careful consideration and consultation with his or her own independent financial advisor;

3.5.6 Exchange Rate Fluctuations

Bondholder has to bear the risk of any fluctuations in exchange rate between the currency of denomination of the Secured Callable Bond – Euro (€) and the investor's currency of reference if this is

3.5.7 Uncertain Future

No prediction can be made about the effect which any future public offerings of the Issuer's securities, or any takeover or merger activity involving the Issuer, will have on the market price of the Secured Callable Bonds prevailing from time to time;

3.5.8 Risk pertaining to Prospects MTF

Application has been made to the MSE for the Secured Callable Bonds to be admitted and traded on Prospects MTF once the Secured Callable Bonds are authorised as admissible by the MSE. Prospects MTF is a market regulated as a multilateral trading facility and operated by the MSE and provides a venue for SMEs to float their securities. MSE has every right to suspend the admission of any security if the Listing rules are not abided with. Consequently, this market is designed primarily for companies to which a higher risk than that associated with established companies tends to be attached. A prospective investor should be aware of the potential risks in investing in such companies and should make the decision to invest only after careful consideration and consultation with his or her own independent financial advisor;

4 Persons Responsible

Each and all of the Directors of the Issuer whose names appear in Section 5.1 hereunder, are the persons responsible for the information contained in this Admission Document. To the best of the knowledge and belief of the Directors, who have taken all reasonable care to ensure that such is the case, the information contained in this Document is in accordance with the facts and contains no omission likely to affect its import. The Directors accept responsibility accordingly.

As at the date of this Document there are no other facts or matters omitted from the Admission Document which were or are necessary to enable investors and their investment advisors to make an informed assessment of the assets and liabilities, financial position, profits and losses and prospects of the Issuer, the Guarantor and of the rights attaching to the Bonds.

5 Identity of Directors, Senior Management, Advisors and Auditors of The Issuer and Guarantor

This document includes information given in compliance with the Prospects MTF Rules for the purpose of giving information with regards to the Issuer.

5.1 Directors of the Issuer

As at the date of this Company Admission Document, the Board of Directors of the Issuer is constituted by the following persons:

| | |
|----------------------|--|
| John Soler | Chairman and Independent, non-Executive Director |
| Kurt Abela | Executive Director |
| Etienne Borg Cardona | Independent, non-Executive Director |

All three Directors serve on the Board of the Issuer. Mr Kurt Abela serves in the capacity of an executive director, whilst Mr Etienne Borg Cardona and Mr John Soler serve in the capacity of non-executive directors. Both non-Executive directors are considered as independent. The Business Address of the Directors is "Project Technik", Cannon Road, Qormi, Malta.

The Company Secretary and Compliance Officer is Darren Micallef.

Etienne Borg Cardona

Etienne Borg Cardona is a certified public accountant and auditor by profession and holds a practicing warrant. Following experience in banking and in audit practice, he has had a thirty-year career in leadership positions in the private sector. He is presently the founding partner of Capital Advisory Limited, an independent consulting firm, and advises on corporate finance, financial management and reporting, and corporate governance.

He currently sits as an independent non-executive director on boards of listed, regulated and private local and international companies in a number of industry sectors. He is an elected council member of the Malta Institute of Accountants and a member of the Malta Chamber of Commerce Family Business Committee.

A Fellow of the Chartered Association of Certified Accountants and the Malta Institute of Accountants, he holds a Masters' degree in Financial Services from the University of Malta, and is currently reading a PhD in Leadership and Management at Cranfield Business School, Cranfield University UK.

He lectures at the University of Malta in the departments of accountancy and public policy within the Faculty of Economics, Management and Accountancy. He has also lectured on the history of finance, commerce and money in modern economies at the University of Malta's Centre for Liberal Arts and Sciences, and as a visiting lecturer at Cranfield Business School.

John Soler

John Soler has more than 45 years' experience in retail banking after holding several senior positions with Bank of Valletta p.l.c. He led the bank's operations for over a decade before being appointed to the senior management team as Chief Officer Credit, with responsibility for Bank of Valletta's lending portfolio comprising corporate, business and consumer lending as well as home loans and card business. Mr Soler is presently chairman of the board of FCM Bank Ltd, and sits on the board of AX Holdings Limited, Valletta Cruise Port p.l.c., Orion Finance p.l.c. and Orion Retail Investments Ltd. He is Chairman of the Audit Committee of AX Holdings Limited, Orion Finance p.l.c., Orion Retail Investments Ltd. and M Demajo Holdings Ltd.

5.2 Senior Management

Kurt Abela - Managing Director

Kurt Abela is an entrepreneur who first set up business as a finishing and general services contractor in 2006. He quickly identified an opportunity for expansion in the market and soon after started an import retail business, providing building supplies to the turnkey contracting industry. In 2012, encouraged by the successful development of both businesses, he set up a property development business.

Darren Micallef - Financial Controller & Company Secretary

Darren Micallef is the Group Financial Controller. He is a Certified Public Accountant and fellow member of both the Malta Institute of Accountants (MIA) and the Association of Chartered Certified Accountants (ACCA). He started working with one of the big audit firms in Malta in 1999, and after one year moved to an established small audit firm for seven years where he gained vast experience in accounting, audit and taxation. After obtaining his warrant in 2008, he moved to Where's Everybody Group, the biggest TV production company in Malta at that time, taking the

role of Group Financial Controller and Company Secretary. In 2013, he joined Project Technik as Financial Controller. In this new position for the group, he managed to upgrade the accounting system to a more professional setup and also upgraded the level of reporting within the group. He also took over all company secretarial work and all taxation related submissions and consultancy.

Joe Caruana Dingli (General Manager – Office Rentals)

Joseph Caruana Dingli started his working career in the banking sector joining Bank of Valletta in 1986. Eight years after, he moved on to the manufacturing industry, managing the exports of a well-established export orientated factory. An enthusiast of the construction trade, Mr Caruana Dingli joined a consortium entrusted with the regeneration of the Vittoriosa Waterfront and its Palaces, serving as Company Secretary to the companies within the group. Working close to the project's architects, he gained valuable experience in the construction, restoration and finishing sectors. Besides taking over the Project Management of this rehabilitation development, he also took care of the leasing out and sales of the finished premises. Mr Caruana Dingli joined KA Holdings Ltd in 2014 as the General Manager seeing through the construction of the first phase of Centris I. He was instrumental in the renting out of the entire block with significant deals as a lease contract of two levels with one of the mayor banks in Malta. Another important role within the company is project managing the finishing works requested by the tenants within the building and ensuring the smooth running of the condominium itself.

Jean Mifsud (General Manager – Hospitality)

Mr Jean Mifsud started his career in 1998 as a Receptionist at the former Sa Maison Hotel in Pieta after few months he was employed by Busy Bee Catering as an Assistant Catering Manager, where he spent almost 3 years in which he gained experience in the catering sector. In 2001 he was employed as an Accounts Executive with Falzon's Bathroom & Ceramics where he was also involved in sales. In 2006 he moved to Galea Ceramics and continued his career in the Bathrooms and Tiles industry. In 2011 he was employed with Project Technik as an Accounts executive, then in 2013 he was promoted to Operations Manager, where his contribution was pivotal at growing the company. In 2016 Jean Mifsud was offered a job as a Furniture Department Manager within the OK Group and then, in 2017, moved to work as a Deputy Manager with Alberta Group, before returning to KA Holdings in 2018 as a Project and Property Manager.

5.3 Advisors to the Issuer

5.3.1 Corporate Advisor,

NAME: EMCS LTD C 68521

ADDRESS: Level 2, Regional Business Centre,
University Heights,
Msida MSD 1751,
Malta



5.3.2 Placement Agent & Manager

NAME: CURMI & PARTNERS LTD C 3909

ADDRESS: Finance House,
Princess Elisabeth Street,
Ta' Xbiex XBX 1102
Malta



5.3.3 Security Trustee

NAME: EMCS INTERNATIONAL LTD C25114

ADDRESS: Level 2, Regional Business Centre,
University Heights,
Msida MSD 1751,
Malta

5.3.4 Auditors to the Issuer & Guarantor

NAME: GRANT THORNTON MALTA

ADDRESS: Fort Business Centre
Floor 2
Mriehel Bypass
Birkirkara, BKR 3000
Malta

6 Information About the Issuer and The Guarantor

6.1 Information on the Issuer

| | |
|---|--|
| Full legal and commercial name of the Issuer: | KA FINANCE PLC |
| Registered address: | "Project Technik", Cannon Road, Qormi Malta. |
| Place of registration and domicile: | Malta |
| Company registration number: | C 91544 |
| Date of registration: | 22 nd April 2019 |
| Legal form: | Public limited liability company |
| Telephone numbers: | +356-21470988 |
| Email: | info@project-technik.com |

The Issuer is, except for one share which is held by Kurt Abela, a fully-owned subsidiary of the Guarantor.

The Issuer was registered as KA Finance plc on 22nd April 2019 registered in terms of the Companies Act, with company registration number C91544. The Issuer is domiciled in Malta, having its registered office at Project Technik, Cannon Road Qormi, QRM 9032 Malta. As at the date of the Company Admission Document, the Issuer has an authorised and issued share capital of €50,000, divided into 50,000 ordinary shares of €1 each, all fully paid-up. At present, the shares in the Issuer are subscribed to and held as indicated in section 10.1 of this Admission Document.

The principal objects of the Issuer relate to carrying on the business of a finance company. Furthermore, the issue of bonds falls within the objects of the Issuer, however, to date the Issuer has no track record in raising finance from capital markets.

6.2 Information on the Guarantor

| | |
|---|--|
| Full legal and commercial name of the Issuer: | K.A. HOLDINGS LIMITED |
| Registered address: | "Project Technik", Cannon Road, Qormi Malta. |
| Place of registration and domicile: | Malta |
| Company registration number: | C 56023 |
| Date of registration: | 19 th April 2012 |
| Legal form: | Private limited liability company |
| Telephone numbers: | +356-21470988 |
| Email: | info@project-technik.com |

The Guarantor is a private limited liability company incorporated and registered in Malta with company registration number C 56023 having its registered office at 'Project Technik', Cannon Road, Qormi Malta.

As at the date of the Company Admission Document the Guarantor has an authorised and issued share capital of 150,000 ordinary shares of €1 each, all fully paid-up and subscribed to and held as indicated in section 10.2 of this Admission Document.

KA Holdings is a property development company incorporated in Malta on 19th April 2012. Its primary business objective is to invest in real estate assets for resale or rental returns.

6.2.1 Organisational Structure

Below is the organisational structure of KA Holdings, which outlines that specialised persons are employed for each important business sector which the Guarantor will be involved in.

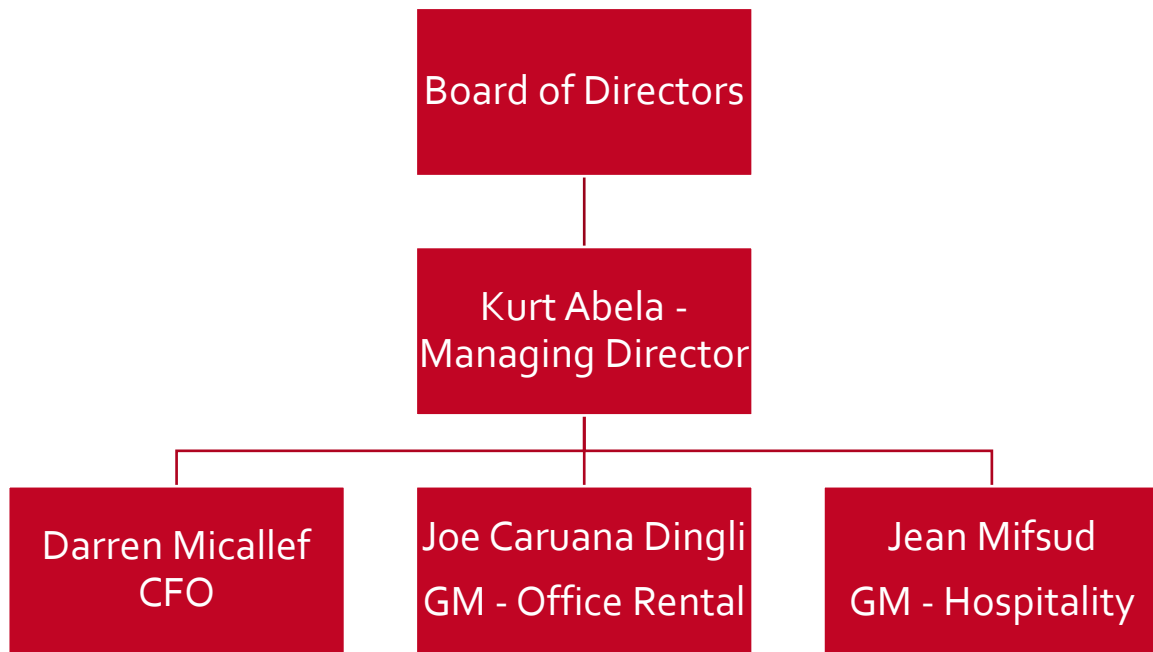

7 Trend information

The Issuer is dependent on the business prospects of the Guarantor and therefore, the trend information of the Guarantor (detailed below) has a material effect on its financial position and prospects.

There has been no material adverse change in the prospects of the Issuer since its incorporation. It should be noted that the Issuer has not yet published audited financial statements as it was incorporated shortly prior to the date of this Company Admission Document.

7.1 Trend information of the Guarantor

7.1.1 Overview of the rental market

The principal objects of the Guarantor is related to developing of office space and renting it out, developing of an apartment complex in Swieqi for short term rental purposes and the refurbishment and eventual operation of a Boutique Hotel in Gzira.

To date the Guarantor has focused on offering renting out office space from its building in Mriehel (Centris I).

Without prejudice to the risks identified in this Document, as at the time of publication of the Company Admission Document, the Issuer and the Guarantor consider that generally they shall be subject to the normal business risks associated with the business in which they operate, and, barring unforeseen circumstances, do not anticipate any particular trends, uncertainties, demands, commitments or events outside the ordinary course of business that could be deemed likely to have a material adverse effect on the upcoming prospects of KA Holdings and its business, at least with respect to the current financial year. However, investors are strongly advised to carefully read the risk factors in the Company Admission Document.

The following is a brief synopsis of the significant trends affecting the key areas of operation of the KA Holdings

7.1.1.1 *Office space rental market*

Malta is presently experiencing an economic boom. The real GDP growth experienced in Malta is outlined below:

Quarterly GDP Growth

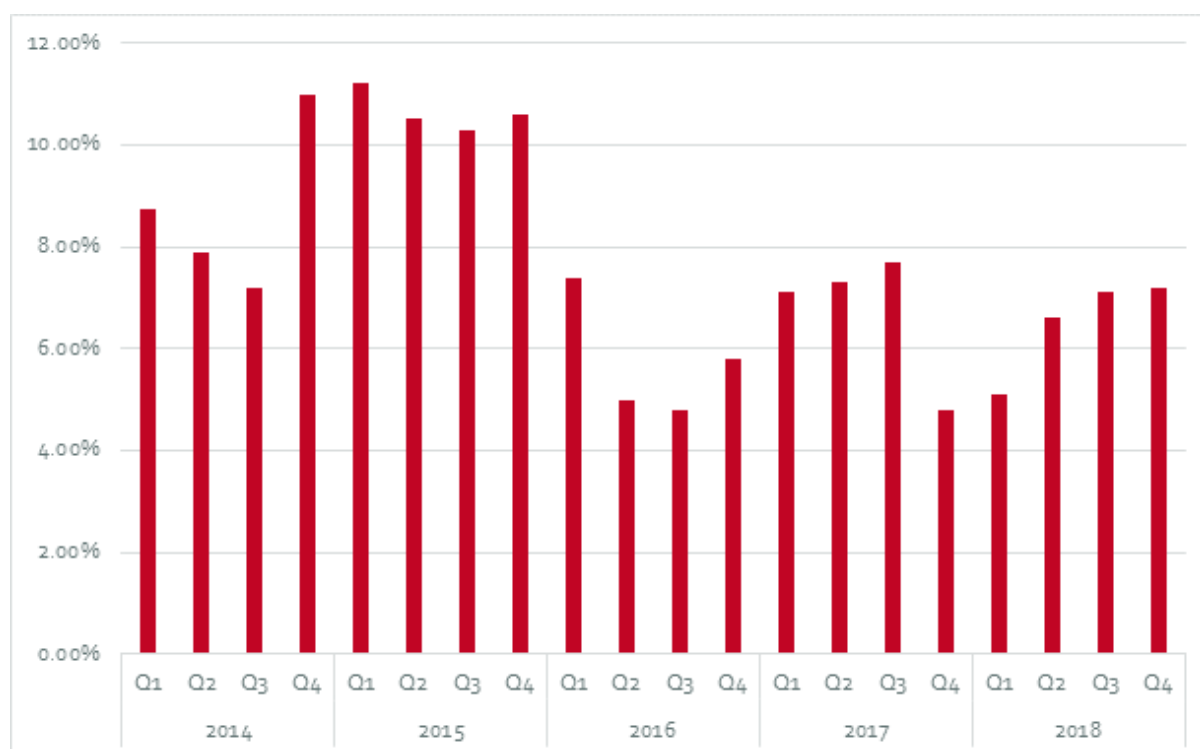

Source: NSO- Gross Domestic Product: 2018 as published on the 8th March 2019

Both the 'construction' and 'real estate activities' experienced a strong growth in the past years. Taking GDP figures for 2018 one can see that the 'construction' sector registered a 10.2%⁴ increase in output in 2018 when compared to 2017 and the 'real estate' sector registered a 13%⁵ increase in output in 2018 when compared to 2017.

A market exercise in which around 40 local real-estate agents participated through telephone interviews, was carried out during the first weeks of January 2018⁶. The results of this exercise

4

https://nso.gov.mt/en/News_Releases/View_by_Unit/Unit_A1/National_Accounts/Documents/2019/News2019_038.pdf

5

https://nso.gov.mt/en/News_Releases/View_by_Unit/Unit_A1/National_Accounts/Documents/2019/News2019_038.pdf

⁶ <https://www.pwc.com/mt/en/publications/middlemarketbarometer/barometer-real-estate-january-2018.html>

outline that 26% of the respondents attribute the surge in demand for property to the increase in the number of foreign workers in Malta. 20% of local real-estate operators deem that the increase in the investment in the buy-to-let market has fuelled the activity in the industry. Other factors affecting the demand for property were determined to be the growth in disposable income, the Government initiatives in the sector, the increase in demand for office space and the Individual Investor Programme.

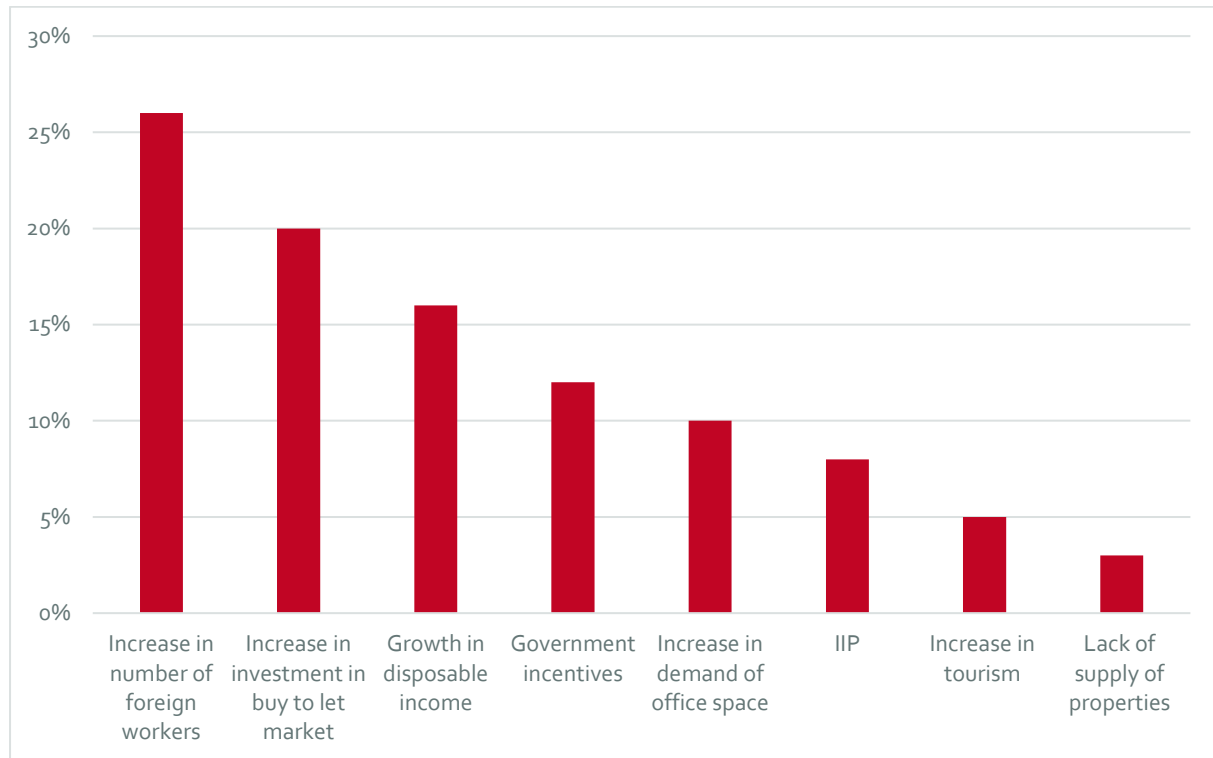

7.1.2 Overview of the hospitality industry

7.1.2.1 The overall tourism performance in Malta

The Maltese tourism industry has, in recent years, been renowned for its unabated growth, with each passing year yielding new record highs of inbound tourists visiting the island. Indeed, the tourism industry is considered to be a crucial pillar of the economy as, directly and indirectly, it is estimated to account for 29% of Malta's GDP (National Tourism Policy 2015-2020).

The strong performance in the tourism sector observed over the past few years has persisted during 2017 in terms of inbound tourists. NSO data for 2018, revealed that the influx for the year stood at 2.6 million tourists – representing an increase of 14.3% over the previous year. Over the past 5 years (2014-2018), there has been a compounded annual growth rate of 11.33% per annum. According to the NSO, this improvement was mostly driven by an increase in the number of leisure tourists. Furthermore, 65.9% of tourists organised their own stay and thus opted for a non-package

holiday. The below figure illustrates the development of the Maltese tourism industry over the past 5 years, showing both percentage growth as well as growth in absolute terms.

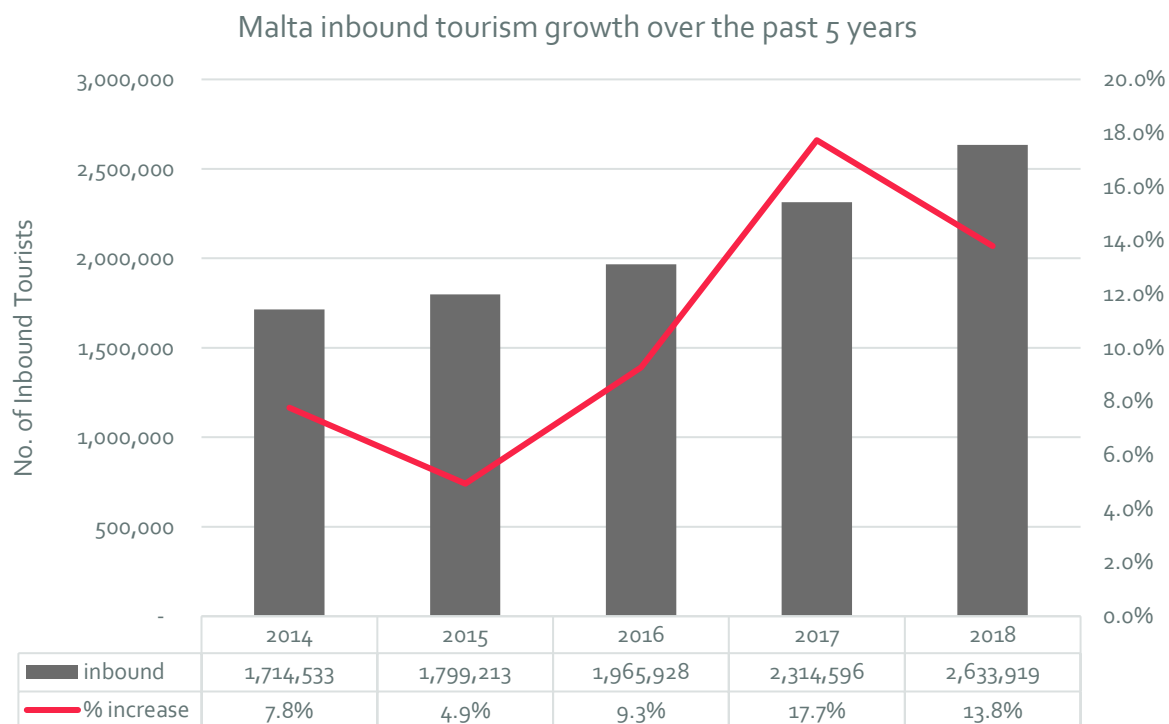

Source: NSO – Inbound Tourism December 2018, as published on the 5th February 2019

The substantial increase in tourist head count over recent years has also increase the aggregate level of tourist expenditure in each year. According to NSO statistics, total tourist expenditure in Malta in 2017 and 2018 stood at €1.9 billion and €2.1 billion respectively, meaning that expenditure increased by 8%. The increase in expenditure was less than the increase in inbound tourism (14.3%), this resulted in a decrease in expenditure per capita. This downward trend in expenditure per capita has been observed for the past 4 years as can be seen from the graph below. During the past 4 years expenditure has decreased by €110 or 12% from €919 in 2015 to €809 in 2018.

This decrease in expenditure per capita was partly due to the fact that air/sea fares have decreased as well as a decrease in the average length of stay, as an increasing number of tourists opted to visit Malta for shorter breaks.

Note: the analysis below does not include cruise passengers

| | <i>total tourist</i> | <i>total expenditure €000</i> | <i>expenditure per capita €</i> | <i>% change</i> |
|------|----------------------|-----------------------------------|-------------------------------------|-----------------|
| 2015 | 1,783,533 | 1,639,067 | 919 | |
| 2016 | 1,965,928 | 1,708,952 | 869 | -5.4% |
| 2017 | 2,273,837 | 1,946,894 | 856 | -1.5% |
| 2018 | 2,598,690 | 2,101,765 | 809 | -5.5% |

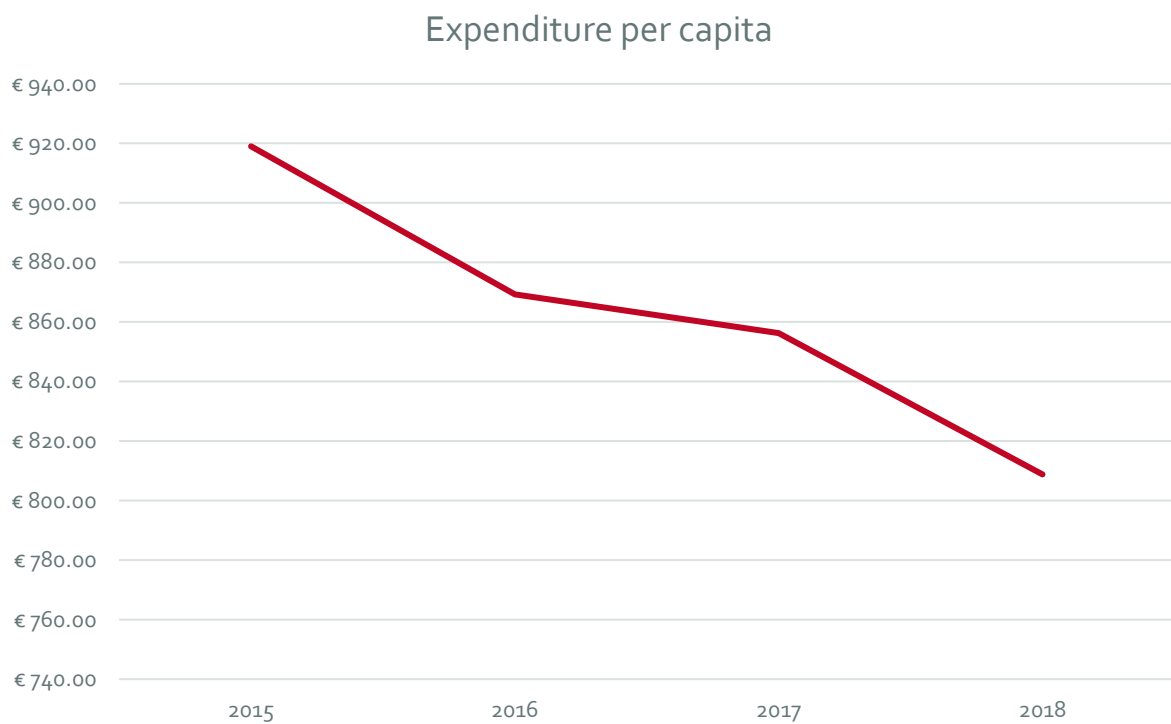

Source: NSO– Inbound Tourism December 2018, as published on the 5th February 2019

8 Financial information on the Issuer & Guarantor

The Issuer was set up on 22nd April 2019 to issue the Secured Callable Bonds and lend the proceeds to Group companies. The Issuer has not conducted any business and has no trading record. Since incorporation to the date of this Admission Document, no financial statements have been prepared in respect of the Issuer.

There has not been any significant change in the financial or trading position of the Issuer, which has occurred since the Issuer's date of incorporation

8.1 Financial information of the Guarantor

KA Holdings is a property development company incorporated in Malta on 19th April 2012. Its primary business objective is to invest in real estate assets for resale or rental returns.

In 2012 the Group acquired 1250sqm of land in a prime site in Mriehel with the objective of developing an office building named Centris Business Gateway. In 2014 an adjacent plot of land of equivalent size was acquired by a related company.

The development was projected to be completed in two phases and with approximately half of the land developed by KA Holdings Ltd for the building of Centris I (Centris 1), which was Phase 1. Construction on this 8-storey building consisting of 5 floors of open-plan office space and 3 floors garage parking, started towards the end of 2013 and was completed in Q1 2016.

8.1.1 Centris I

By the end of 2017 Centris I was essentially fully rented out to 8 blue chip tenants operating in different industries mainly within the Banking and financial sector (44%), Medical Aesthetics (17%) and creative marketing (10%). All the contracts entered into by the guarantor are for periods of between 4 and 15 years. However, 77% of the contracts in terms of rental income are for periods of between 10 and 15 years. The contracts also stipulate a 2% yearly increase in rent payable by the tenants. Tenants are also responsible for the general repairs and maintenance on equipment which they have bought and installed within their particular rented space. Furthermore, any maintenance expense incurred by KAH will be recharged to the tenants.

In 2018 the company generated a total of €600K in rental income. In early 2019 the company rented out the last of the available spaces to a gaming company taking the number of tenants to 9.

A valuation report was issued on the 6th May 2019, which is based on having 92% of all rentable space (both commercial as well as parking facilities) forming part of the property in question being

rented out. When this rental value is capitalised at the rate of 5.0% (considered to be an average rate of rental return for similar properties in the Maltese market), the market value of the property in question, in its current state was set at €12million.



Centris Gateway Building (CENTRIS I)

With regards the Guarantor, since its incorporation to the date of the Company Admission Document 6 sets of financial statements has been prepared. The Guarantor's historical financial information for the financial year ended 31st December 2018, was audited by Grant Thornton Malta.

There were no significant changes to the financial or trading position of the Guarantor or the Group since the end of the financial period 31st December 2018.

8.1.2 Income statement

Consolidated income statement for the years ending 31 December

| | A 2017 | A 2018 | B 2019 | P 2020 | P 2021 | P 2022 | P 2023 |
|--|------------------|------------------|------------------|------------------|------------------|------------------|------------------|
| Revenue | | | | | | | |
| Centris 1 | 483,930 | 685,607 | 749,432 | 773,168 | 788,203 | 803,543 | 819,193 |
| Centris 2 | - | - | - | 237,884 | 922,054 | 927,837 | 945,981 |
| Swieqi | - | - | - | 394,408 | 484,858 | 509,391 | 535,167 |
| Gzira | - | - | - | 29,023 | 124,124 | 130,404 | 137,003 |
| Total revenue | 483,930 | 685,607 | 749,432 | 1,434,484 | 2,319,238 | 2,371,175 | 2,437,342 |
| Cost of sales | | | | | | | |
| Centris 1 | - | (24,000) | (24,480) | (24,970) | (25,469) | (25,978) | (26,498) |
| Centris 2 | - | - | - | (12,000) | (24,480) | (24,970) | (25,469) |
| Swieqi | - | - | - | (95,977) | (138,441) | (144,086) | (160,896) |
| Gzira | - | - | - | (10,820) | (45,012) | (46,813) | (48,685) |
| Total cost of sales | - | (24,000) | (24,480) | (143,767) | (233,403) | (241,847) | (261,548) |
| Gross profit | | | | | | | |
| Centris 1 | 483,930 | 661,607 | 724,952 | 748,199 | 762,734 | 777,564 | 792,695 |
| Centris 2 | - | - | - | 225,884 | 897,574 | 902,868 | 920,512 |
| Swieqi | - | - | - | 298,431 | 346,416 | 365,305 | 374,271 |
| Gzira | - | - | - | 18,203 | 79,111 | 83,591 | 88,317 |
| Total gross profit | 483,930 | 661,607 | 724,952 | 1,290,717 | 2,085,836 | 2,129,328 | 2,175,795 |
| Administrative expenses | | | | | | | |
| Centris 1 | (50,921) | (61,484) | (62,800) | (64,147) | (65,526) | (66,937) | (68,381) |
| Centris 2 | - | - | - | (46,629) | (94,989) | (84,760) | (86,572) |
| Swieqi | - | - | - | (42,272) | (86,536) | (88,575) | (90,665) |
| Gzira | - | - | - | (16,580) | (67,647) | (69,000) | (70,380) |
| Other costs (CA & trust) | - | - | (44,750) | (63,000) | (63,000) | (63,000) | (63,000) |
| Total Administrative expenses | (50,921) | (61,484) | (107,550) | (232,629) | (377,698) | (372,273) | (378,999) |
| Operating profit | 433,009 | 600,123 | 617,402 | 1,058,087 | 1,708,137 | 1,757,055 | 1,796,796 |
| Depreciation | - | - | - | (20,000) | (57,000) | (57,000) | (57,000) |
| PBIT | 433,009 | 600,123 | 617,402 | 1,038,087 | 1,651,137 | 1,700,055 | 1,739,796 |
| Interest | | | | | | | |
| Bank | (89,492) | (129,386) | (117,551) | (111,001) | (104,107) | (96,851) | (89,214) |
| Interest on Prospects MTF Bond | - | - | - | (148,500) | (297,000) | (297,000) | (297,000) |
| Total interest | (89,492) | (129,386) | (117,551) | (259,501) | (401,107) | (393,851) | (386,214) |
| Profit before tax | 343,517 | 470,737 | 499,851 | 778,587 | 1,250,031 | 1,306,205 | 1,353,582 |
| Tax | (66,268) | (90,505) | (103,719) | (179,579) | (290,636) | (301,970) | (309,977) |
| Net profit before Fair Value gain | 277,249 | 380,232 | 396,131 | 599,007 | 959,395 | 1,004,235 | 1,043,605 |
| Fair Value gain on IP | 2,258,060 | 1,071,115 | 5,172,827 | 4,401,500 | - | - | - |
| Deferred Tax on Fair Value gain | (264,000) | (96,000) | (1,340,416) | - | - | - | - |
| Total Net Profit | 2,271,309 | 1,355,347 | 4,228,542 | 5,000,507 | 959,395 | 1,004,235 | 1,043,605 |

A – Audited

B- Budgeted

P – Projected

8.1.2.1 Revenue

Through the Bond Issue, the Group is projecting to expand its core business by investing in immovable property and diversifying its business by operating a hostel and boutique hotel.

Revenue from different streams

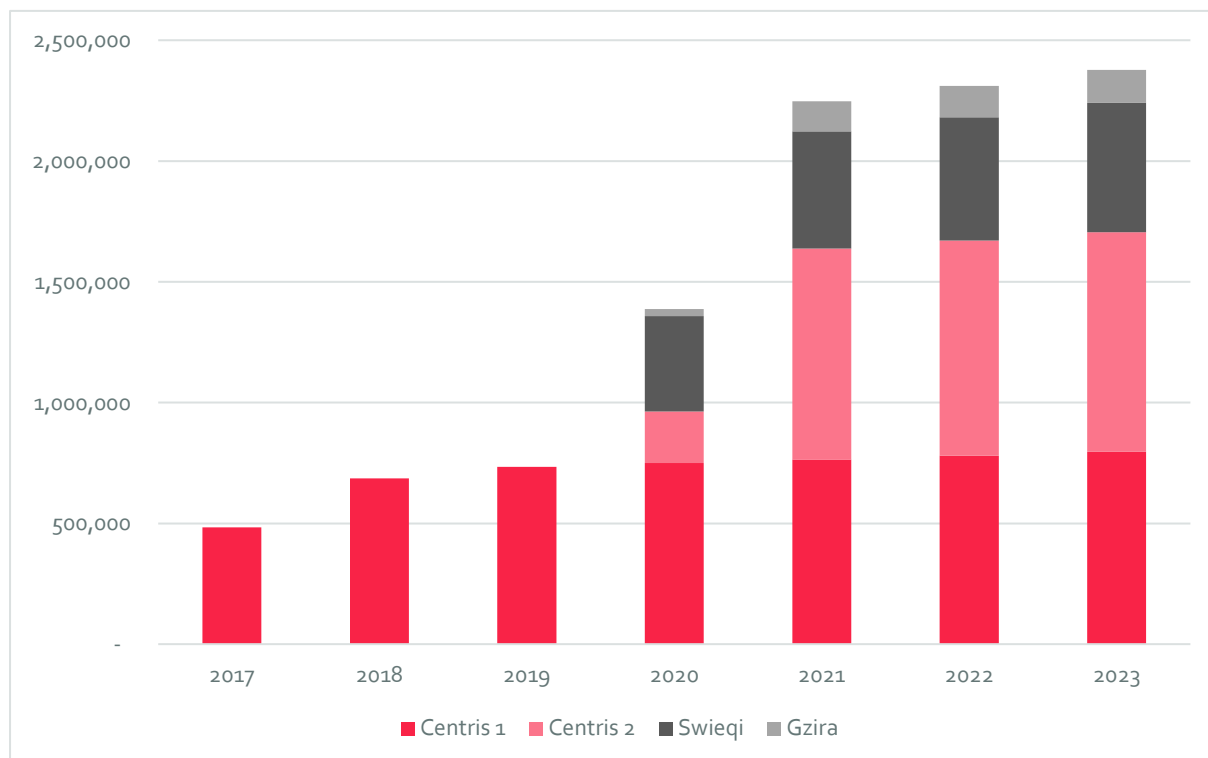

Currently revenue is only generated from one source, Centris I. By the end of 2017 Centris I was almost fully leased out and in 2018 the company generated revenue amounting to €0.685 million which included rental income and recharge of expenses to tenants. Rental income will increase by 2% per annum as stated in the rental contracts.

In 2019 with the proceeds from the Bond the company will commence with the development of three properties; Centris II, Swieqi apartment complex and Gzira boutique hotel.

The Centris building will be completed with the development of Centris II on the plot of land adjacent to Centris I.

8.1.2.2 Centris II

Centris II will be developed into a building offering 5,500 sqm of office space and underground parking. The plot of land adjacent to Centris I is currently owned by PTL (related party) and will be transferred to KAH for €2million. The plot of land was originally purchased by PTL back in 2014 for €1.4million. Since then PTL incurred a total of €0.6million in excavation, hence the transfer price

of €2million. The KAH will spend €1.9million on construction and €1million on furnishings for a total project costs of €4.9 million.

It is projected that Centris II will be completed in Q2 2020 and fully rented out in early 2021 and generate revenues of almost €0.9million. Centris II will be the highest revenue generating asset from 2021 onwards as it is expected to generate 38% of total revenue. The contracts with the tenants for Centris II will be in line with the current contracts for Centris I, therefore, tenants will be responsible for repairs & maintenance and rent payable will increase by 2% per annum.

Planning Permits to have Centris II developed have been issued in March 2019, with the planning permit number being PA04584/17. Further details are found in the relevant valuation in Annex A

8.1.2.3 Strategy for Centris II

With the experience gained when Centris I was being rented out, the strategy for having the office space being built in Centris II rented out in the stipulated timeline, rests on the following strategic points:-

- Location: Mriehel is becoming ever more a very important business centre. The Planning Authority has the strategic objectives for the transformation of Mriehel Industrial Area into a high-quality enterprise hub.
- Timing: Centris II will be completed by mid- 2020, much ahead of larger development projects, also intended for office rental in Mriehel. This means that Centris II will be available to satisfy the need for office space in Mriehel much before other projects.
- Price: Centris II will offer rental prices which are much more competitive than competing projects being presently developed in Mriehel, whilst still offering high-quality office space and car parking facilities.

8.1.2.4 Swieqi apartment complex

The site in Swieqi was acquired in 2018 for €0.45million by KA Holdings. Permits have been issued (PA 08699/17) and work has commenced to redevelop the property into a 15-apartment complex, complete with communal pool. This development is expected to cost €0.8million. The apartments will be offered for short term leases via AirBnB. Further details are found in the relevant valuation in Annex A.

Revenue projections are based on an average occupancy rate of 60% in the first year and increase by 2% each year, in line with current industry trends. Rates per night will fluctuate during the year depending on the season, however, the average apartment rate per night is expected to be €150 including 7% VAT.

The Graph below shows the expected monthly occupancy rate over a year.

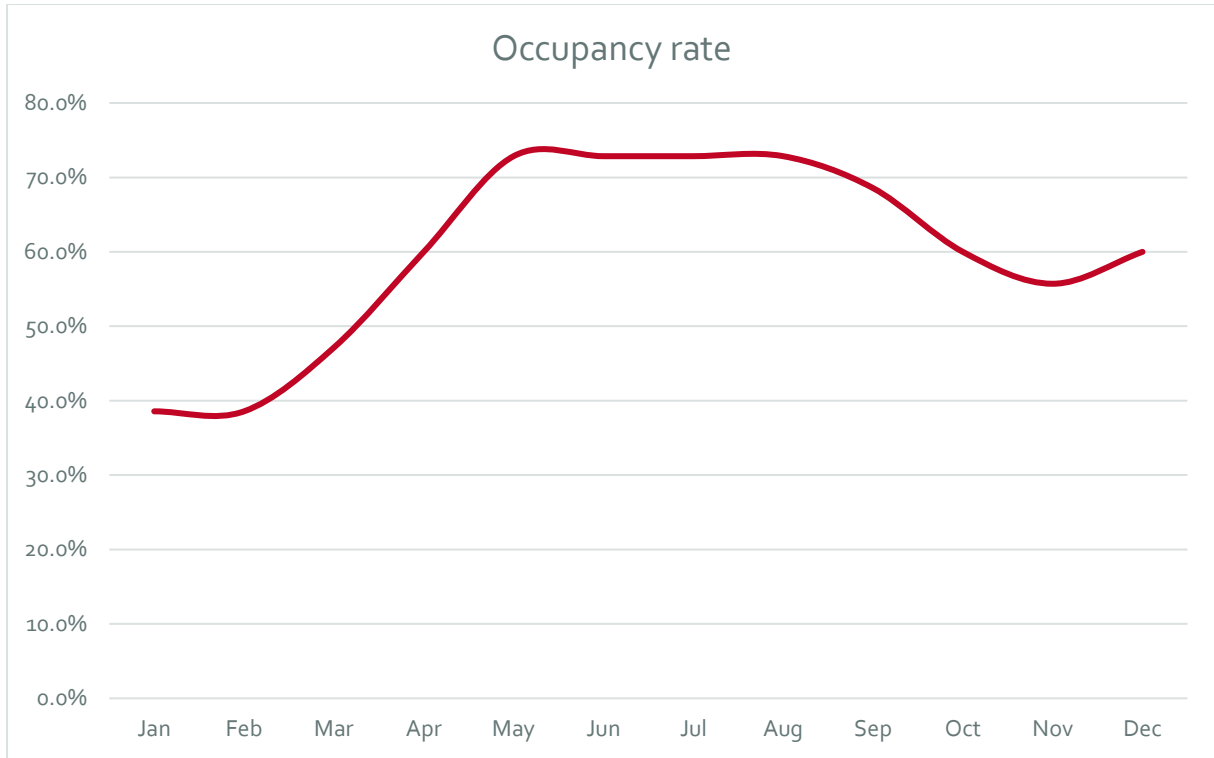

8.1.2.5 Gzira boutique hotel

This property was bought in August 2018 by KA Holdings for €0.3million and will be converted into an 8-room boutique hotel, covered by Planning Permit (PA 02735/18) issued in January 2019. This part of the project is predicted to be completed in Q3 2020. Revenue was based on an average occupancy rate of 60% and weighted average room rates of €72 (€50 in Q1, €70 in Q2, €110 in Q3 and €45 in Q4). These rates were taken after observing room rates of similar hotels in that area. The expected revenue in 2021 (first full year) from the boutique hotel is €124K. Further details are found in the relevant valuation in Annex A.

8.1.2.6 Total revenue

It is predicted that each property will be operating at its maximum potential by early 2022. Revenue in that year should exceed €2.3 million. As it can be seen from the chart below in the financial year 2023, 71% of total revenue is expected to be generated from the two Centris buildings with Centris I and Centris II generating 33% and 38% respectively.

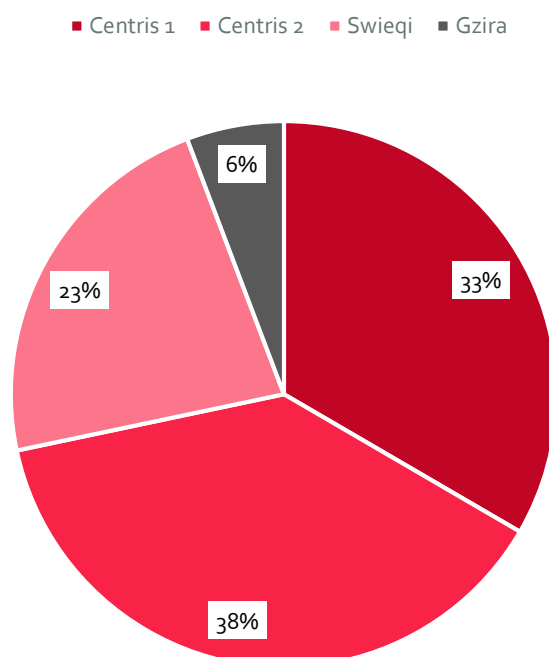

8.1.2.7 Cost of sales

Historically, the company had very minimal cost of sales, mainly wage expenses, since it only rented out office spaces. However, as new lines of business are brought in by the apartment complex and the boutique hotel, the company shall start incurring direct costs attributable to these supply of services. Cost of sales will mainly consist of cleaning & laundry, water & electricity and food and beverages. These will cost the company (both for the Gzira and Swieqi property) over €200K in 2021. Total Gross profit is predicted to grow at a compounded annual growth rate of 31% between 2019 and 2023 and it is expected that the company generates over €2.1 million in gross profits in 2023.

| | 2017 | 2018 | 2019 | 2020 | 2021 | 2022 | 2023 |
|---------------------|---------|----------|----------|-----------|-----------|-----------|-----------|
| | A | A | B | P | P | P | P |
| Revenue | 483,930 | 685,607 | 749,432 | 1,434,484 | 2,319,238 | 2,371,175 | 2,437,342 |
| Cost of sales | - | (24,000) | (24,480) | (143,767) | (233,403) | (241,847) | (261,548) |
| Gross profit | 483,930 | 661,607 | 724,952 | 1,290,717 | 2,085,836 | 2,129,328 | 2,175,795 |
| Gross profit margin | 100% | 96% | 97% | 90% | 90% | 90% | 89% |
| Gross profit growth | | 37% | 10% | 78% | 62% | 2% | 2% |
| | | | | | CAGR | 32% | |

A- Audited

B- Budgeted

P- Projected

8.1.2.8 Administrative, selling and distribution expenses

During the 2018 financial year total administrative costs stood at €0.06million. Over the next 4 years (2020–2023) an increase in administrative costs will be required to support the new operations. In fact, administrative costs are expected to increase from €0.06 million in 2018 to €0.35 million in 2023. The main administrative costs will be water and electricity, repairs and maintenance and the wages of employees which include the wage of the general manager responsible for running the apartment complex and boutique hotel.

8.1.2.9 EBITDA (operating profit)

During 2018 EBITDA totalled €0.6million an increase of €0.17 million (38.6%) over the previous year. EBITDA is expected to increase with the increase in operations and is expected to exceed €1.7million in 2021.

8.1.2.10 Depreciation and amortisation

Depreciation is expected to increase to €0.057 million from 2021 onwards due to the higher value of property plant and equipment. Depreciation is expected to stay constant at this level since the company adopts a straight-line depreciation policy.

Amortisation costs will be fully attributed to the amortisation of the bond issue costs.

8.1.2.11 Finance costs

Historical finance costs are primarily interest cost on a variable interest BOV loan. Finance costs are expected to increase with the issue of the bond. Interest costs during the construction period will be capitalised in accordance with IAS 23 borrowing costs.

8.1.2.12 Tax

The company will adopt the 15% FWT regime on rental income from Centris I and Centris II and the 35% tax regime on the luxury apartments and boutique hotel.

8.1.2.13 Fair value gain

Fair value gain on IP includes the revaluation of all 4 properties to reflect current market prices. Centris II will be revalued to €7 million in 2019 when the building is half complete and re-valued to €14 million when the building is fully finished.

8.1.2.14 Profit after tax

For the year ended 31st December 2018 the company registered total net profit after tax of €0.33 million. The company is expected to still be profitable in 2019. Net profit is expected to increase year on year and predicted to reach almost €1 million by the end of 2023

8.1.3 Statement of financial position

Consolidated statement of financial position as at 31st December

| | A 2017 | A 2018 | P 2019 | P 2020 | P 2021 | P 2022 | P 2023 |
|--------------------------------------|-------------------|-------------------|-------------------|-------------------|-------------------|-------------------|-------------------|
| ASSETS | | | | | | | |
| Non-current assets | | | | | | | |
| Investment property | | | | | | | |
| Centris 1 | 10,800,000 | 12,000,000 | 12,000,000 | 12,000,000 | 12,000,000 | 12,000,000 | 12,000,000 |
| Centris 2 | - | - | 7,000,000 | 14,000,000 | 14,000,000 | 14,000,000 | 14,000,000 |
| Swieqi | - | 646,681 | 2,281,650 | 2,261,650 | 2,221,650 | 2,181,650 | 2,141,650 |
| Gzira | - | 212,942 | 473,550 | 473,550 | 456,550 | 439,550 | 422,550 |
| Total Investment property | 10,800,000 | 12,859,623 | 21,755,200 | 28,735,200 | 28,678,200 | 28,621,200 | 28,564,200 |
| Other | | | | | | | |
| Financial assets | 36,736 | 36,736 | 36,736 | 36,736 | 36,736 | 36,736 | 36,736 |
| Total non-current assets | 10,836,736 | 12,896,359 | 21,791,936 | 28,771,936 | 28,714,936 | 28,657,936 | 28,600,936 |
| Current assets | | | | | | | |
| Trade and other receivables | 223,789 | 350,813 | 184,791 | 353,708 | 571,867 | 584,673 | 600,989 |
| Cash and cash equivalents | 42,282 | 12,362 | 2,849,037 | 404,180 | 1,295,175 | 2,073,356 | 2,880,095 |
| Total current assets | 266,071 | 363,175 | 3,033,828 | 757,888 | 1,867,041 | 2,658,030 | 3,481,084 |
| Total assets | 11,102,807 | 13,259,534 | 24,825,764 | 29,529,824 | 30,581,977 | 31,315,965 | 32,082,019 |
| EQUITY AND LIABILITIES | | | | | | | |
| Capital and reserves | | | | | | | |
| Share capital | 150,000 | 150,000 | 150,000 | 150,000 | 150,000 | 150,000 | 150,000 |
| Retained earnings | 280,486 | 660,719 | 1,056,850 | 1,655,858 | 2,615,253 | 3,619,488 | 4,663,092 |
| Revaluation reserve | 5,764,508 | 6,739,623 | 10,572,034 | 14,973,534 | 14,973,534 | 14,973,534 | 14,973,534 |
| Total equity | 6,194,994 | 7,550,342 | 11,778,884 | 16,779,392 | 17,738,787 | 18,743,022 | 19,786,626 |
| Non-current liabilities | | | | | | | |
| Interest-bearing borrowings | 1,914,123 | 1,855,722 | 1,982,985 | 1,844,775 | 1,699,310 | 1,546,208 | 1,385,068 |
| MTF prospects Bond | - | - | 6,102,750 | 6,114,750 | 6,126,750 | 6,138,750 | 6,150,750 |
| Shareholder's loans | - | - | - | - | - | - | - |
| Amounts due to related parties | - | 812,320 | 812,320 | 812,320 | 662,320 | 512,320 | 362,320 |
| Deferred taxation | 864,000 | 960,000 | 2,300,416 | 2,300,416 | 2,300,416 | 2,300,416 | 2,300,416 |
| Security Deposits received | 403,053 | 406,052 | 454,177 | 598,552 | 598,552 | 598,552 | 598,552 |
| Total non-current liabilities | 3,181,176 | 4,034,094 | 11,652,648 | 11,670,813 | 11,387,348 | 11,096,246 | 10,797,106 |
| Current liabilities | | | | | | | |
| Interest-bearing borrowings | 137,872 | 126,832 | 131,315 | 138,209 | 145,465 | 153,102 | 161,140 |
| Trade and other payables | 1,518,076 | 1,453,840 | 1,159,197 | 761,830 | 1,019,741 | 1,021,626 | 1,027,170 |
| Current taxation | 70,689 | 94,426 | 103,719 | 179,579 | 290,636 | 301,970 | 309,977 |
| Total current liabilities | 1,726,637 | 1,675,098 | 1,394,232 | 1,079,619 | 1,455,843 | 1,476,698 | 1,498,287 |
| Total liabilities | 4,907,813 | 5,709,192 | 13,046,879 | 12,750,432 | 12,843,191 | 12,572,944 | 12,295,393 |
| Total equity and liabilities | 11,102,807 | 13,259,534 | 24,825,764 | 29,529,824 | 30,581,977 | 31,315,965 | 32,082,019 |

A – Audited

B- Budgeted

P – Projected

The financial position of the group is expected to strengthen as a result of the growth in revenue from the new operations introduced in 2021.

8.1.3.1 Assets

The Group's non-current assets as at 31st December 2018 stood at €13million, which included the market value of Centris 1 which has recently been revalued to €12million as stated in section 8.1.1

Non-current assets are expected to exceed €28million by the end of 2020. This rapid increase in growth in non-current assets will be driven by the land acquisition and subsequent development of Centris 2 made by KAH during 2019. This property will be bought at cost from a related party and revalued upwards by the end of 2019. Centris 2 is expected to be revalued to €14million and the apartment complex and boutique hotel will be revalued to €2.3 million and €0.473 Million respectively.

On these 3 properties a valuation exercise has already been carried out.

Note: in 2019 the Gzira boutique hotel and Swieqi Apartment complex will be reclassified as Property, Plant and Equipment (PPE) since these two properties will be rented out on short lets.

8.1.3.2 Centris II

The annual rental return of Centris II when built including the office space and parking spaces is calculated at circa €0.79million per annum. For capitalisation purposes, however, this annual return has been reduced to €0.7million. When this amount is capitalised at 5%, then the value of the built-up asset will be of €14million.

8.1.3.3 Boutique Hotel (Gzira)

The architect's valuation dated 6th May 2019 values this property in its current state at €0.28million. The same architect's valuation, using a comparative method values the property once built in shell form for a value of €0.55million.

8.1.3.4 Swieqi Apartment complex

As per architect's valuation dated 6th May 2019 the value of the property in its present state using the residual method, is set at €0.835million. The same architect's valuation estimates using a comparative method that once the property is build up and finished it can reach a total value of €2.65million.

8.1.3.5 Current Assets

As at 31st December 2018 trade and other receivables amounted to €0.35 million, of which €0.19 million were prepaid expenses. Vat refundable and amounts due by related parties accounted for €0.041 Million and €0.062 Million respectively. Trade and other receivables are expected to increase from €0.35 Million in FY 2018 to €0.6 Million in FY2023. The guarantor closed the 2018

financial year with a cash balance of €0.012 Million. Cash and cash equivalents are predicted to increase in line with the increase in profits.

8.1.3.6 Equity

Total equity of the guarantor as at 31st December 2018 amounted to €7.5million, following the €6.8million revaluation of Centris 1. Total equity is predicted to exceed €18million by the end of 2021. This growth will be driven by the expected increase in retained earnings and revaluation of all four properties. Retained earnings and revaluation reserves for the FY 2023 are expected to equal €4.1million and €15.1million respectively.

8.1.3.7 Liabilities

Total liabilities amounted to €5.7million as at 31st December 2018, €4million non-current liabilities and €1.7million current liabilities. The BOV loan of €1.98million accounted for almost half of the total non-current liabilities. The remaining €2 million were split between amounts due to related parties (€0.812Million), deferred taxation (€0.929Million) and security deposits. The related party loans are interest free. The related party loans will start being repaid as from the year 2021 and the maximum annual repayment shall not surpass €0.15Million.

The deferred tax liability arose due to the revaluation of Centris 1 and was calculated on 8% final withholding tax on the market value of the property.

Gearing ratio (debt/ (debt + equity)) as at 31st December 2018 stood at 27%. Gearing ratio for the FY 2019 is estimated to increase to 50% after the issue of the Bond Note that the debt components is composed of bank loans, long term related party loans and the Bond.

8.1.4 Statement of cash flow

Consolidated statement of cash flows for the years ending

| | A | A | P | P | P | P | P |
|---|--------------------|------------------|--------------------|--------------------|------------------|------------------|------------------|
| | 2017 | 2018 | 2019 | 2020 | 2021 | 2022 | 2023 |
| | € | € | € | € | € | € | € |
| Cash flows from operating activities | | | | | | | |
| Total Net Profit | 2,271,309 | 1,355,347 | 4,228,542 | 5,000,507 | 959,395 | 1,004,235 | 1,043,605 |
| Adjustments Fair Value gain | (1,994,060) | (975,115) | (3,832,411) | (4,401,500) | - | - | - |
| Net income Before Fair Value gain | 277,249 | 380,232 | 396,131 | 599,007 | 959,395 | 1,004,235 | 1,043,605 |
| Interest | 89,492 | 129,386 | 117,551 | 259,501 | 401,107 | 393,851 | 386,214 |
| Tax | 66,268 | 90,505 | 103,719 | 179,579 | 290,636 | 301,970 | 309,977 |
| Operating profit | 433,009 | 600,123 | 617,402 | 1,038,087 | 1,651,137 | 1,700,055 | 1,739,796 |
| depreciation | - | - | - | 20,000 | 57,000 | 57,000 | 57,000 |
| Changes in working capital | | | | | | | |
| (Increase) decrease in receivables | (400,810) | (127,024) | 166,022 | (168,917) | (218,159) | (12,806) | (16,315) |
| (Increase) decrease inventory | - | - | - | - | - | - | - |
| Increase (decrease) payables | 241,690 | 751,083 | (246,518) | (252,992) | 107,911 | (148,115) | (144,456) |
| Interest Paid | (89,492) | (129,386) | (117,551) | (396,001) | (389,107) | (381,851) | (374,214) |
| Tax Paid | - | (66,768) | (94,426) | (103,719) | (179,579) | (290,636) | (301,970) |
| Cash from operating activities | 184,397 | 1,028,028 | 324,928 | 136,459 | 1,029,204 | 923,647 | 959,841 |
| Cash flows from investing activities | | | | | | | |
| Purchase of property plant and equipment | (1,010,822) | (988,507) | (3,500,000) | (2,450,000) | - | - | - |
| Purchase of financial assets | | | | | | | |
| (Payments to)/from Sinking fund | | | | | | | |
| Net cash from investing activities | (1,010,822) | (988,507) | (3,500,000) | (2,450,000) | - | - | - |
| Cash flows from financing activities | | | | | | | |
| Proceeds from loans | 892,371 | 43,489 | 256,511 | | | | |
| Payments of loans excluding interest | | (112,930) | (124,765) | (131,315) | (138,209) | (145,465) | (153,102) |
| Share capital | | | | | | | |
| Proceeds from MTF prospects Bond | | | 5,880,000 | | | | |
| Payments of MTF prospects Bond | | | | | | | |
| Net cash from financing activities | 892,371 | (69,441) | 6,011,746 | (131,315) | (138,209) | (145,465) | (153,102) |
| Net cash movement for the period | 65,946 | (29,920) | 2,836,674 | (2,444,856) | 890,994 | 778,182 | 806,739 |
| Opening cash balance | (23,664) | 42,282 | 12,362 | 2,849,037 | 404,180 | 1,295,175 | 2,073,356 |
| Closing cash balance | 42,282 | 12,362 | 2,849,037 | 404,180 | 1,295,175 | 2,073,356 | 2,880,095 |

A – Audited

B- Budgeted

P – Projected

During FY 2017 and FY 2018 the guarantor invested over €1.6million in property plant and equipment. As it can be seen the company is expected to remain in a cash positive position throughout the projected period. The bond proceeds, net of issue costs, will be fully invested in non-current assets which will be split as follows:

8.1.4.1 *Centris 2*

- Plot of land €2million (land €1.4million + €0.6million excavation & capitalisation of interest already incurred by a related party).
- Construction: €1.9 million
- Furnishings and Finishings: €1 million

8.1.4.2 *Swieqi apartment complex*

- Excavation and construction: €0.5million
- Furnishings: €0.3million

8.1.4.3 *Gzira boutique hotel*

- Refurbishment and Finishings: €0.18million

9 Management and Administration

9.1 The Issuer

9.1.1 The Board of Directors of the Issuer

The Memorandum of Association of the Issuer provides that the affairs of the Issuer shall be managed and administered by a Board of Directors to be composed of not less than three (3) and not more than seven (7) Directors, who are appointed by the shareholders.

Directors of the Issuer are appointed by means of an ordinary resolution in general meeting. Accordingly, the Guarantor is empowered to appoint the Directors of the Issuer, thereby putting it in a position to appoint an absolute majority of the Directors of the Issuer and, accordingly, have control over the management and operations of the Issuer.

The Issuer is currently managed by a Board of three (3) Directors, who are responsible for the overall direction and management of the Issuer. The Board currently consists of one executive Director, who is entrusted with the Issuer's day-to-day management and 2 non-executive Directors, both of which independent of the Issuer, whose main functions are to monitor the operations of the executive Director. In line with Prospects MTF Rules and generally accepted principles of sound corporate governance, at least one (1) of the Directors shall be a person independent of the Group. All of the Directors of the Issuer were elected by the shareholders upon the Issuer's incorporation and no Directors have been removed and no further Directors have been elected and appointed since the Issuer's inception.

As at the date of the Company Admission Document, the Board of the Issuer is composed of the individuals listed in section 5.1.1 of this Company Admission Document.

None of the Directors of the Issuer have been:

- a) convicted in relation to fraud or fraudulent conduct in the last five (5) years;
- b) made bankrupt or associated with any liquidation or insolvency caused by action of creditors;
- c) the subject of any official public incrimination or sanction by any statutory or regulatory authority; or
- d) disqualified by a court from acting as director or manager in the last five (5) years.

The Directors believe that the Issuer's current organisational structure is adequate for its present activities. The Directors will maintain this structure under continuous review to ensure that it meets the changing demands of the business and to strengthen the checks and balances necessary for better corporate governance.

9.1.2 Non-Executive Directors

The non-executive Directors' main functions are to monitor the operations of the executive Directors and their performance, as well as to review any proposals tabled by the executive Directors.

The Non-Executive Directors are Etienne Borg Cardona and John Soler

9.1.3 Directors' service contracts

None of the directors have a service contract with the Issuer.

9.1.4 Conflict of interest

Etienne Borg Cardona and John Soler sit solely on the board of KA Finance PLC and do not sit on any board or audit committee of any other company related to the issuer or the guarantor.

The Audit Committee of the Issuer has the task of ensuring that any potential conflicts of interest that may arise at any moment pursuant to these different roles held by directors are handled in the best interest of the Issuer and the Guarantor and according to law. The fact that the Audit Committee of the Issuer is constituted with a majority of non-executive Directors, who are also independent of KA Holdings, provides an effective measure to ensure that transactions between related parties vetted by the Audit Committee are determined on an arm's length basis at all times and on a continuing basis.

9.1.5 Loans to Directors

There are no loans outstanding by the Issuer to any of its Directors, nor any guarantees issued for their benefit by the Issuer.

9.1.6 Removal of Directors

In terms of the Issuer's Articles of Association, unless appointed for a longer or shorter period, or unless they resign or are removed, Directors shall hold office for a period of one (1) year. Provided that no appointment may be made for a period exceeding three (3) years. Provided further that an election of Directors shall take place every year. All Directors shall retire from office every year, but shall be eligible for re-election. The Directors of the Issuer currently in office are expected to remain in office at least until the next annual general meeting of the Issuer.

The present directors shall remain in office until they resign, retire or are removed at any time by the shareholders.

9.1.7 Powers of Directors

By virtue of the provisions of the Articles of Association of the Issuer, the Directors are empowered to transact all business which is not by the Articles expressly reserved for the shareholders in general meeting. Specifically, the Directors are vested with the management of the Issuer and their powers of management and administration emanate directly from the Memorandum and Articles of Association and the law. The Directors are empowered to act on behalf of the Issuer and, in this respect, have the authority to enter into contracts, sue and be sued in representation of the Issuer.

Directors may not vote on any contract, arrangement or investment in which they have a personal material interest, whether direct or indirect.

In terms of the Memorandum and Articles of Association, the Board of Directors may exercise all the powers of the Issuer to borrow money and to issue debentures, debenture stock and other securities whether outright or as security for any debt, liability or obligations of the Issuer or of any third party as it thinks fit, subject to any limit as may be established in the Articles of Association and the overriding authority of the shareholders in general meeting to change, amend, restrict and/or otherwise modify such limit and the Directors' borrowing powers.

The Non-Executive directors' main functions are to monitor the Group operations as well as ensure that the interests of the Bondholders are upheld at all times.

9.1.8 Aggregate emoluments of Directors

Pursuant to the Issuer's Articles of Association, the maximum annual aggregate emoluments that may be paid to the Directors are approved by the shareholders in general meeting.

The remuneration of Directors is a fixed amount per annum and does not include any variable component relating to profit sharing, share options or pension benefits.

For the financial year ending on the 31st December 2020 it is expected that the Issuer will pay an aggregate of €45,000 to its Directors.

9.1.9 Working capital

As at the date of the Company Admission Document, the Directors of the Issuer and the directors of the Guarantor are of the opinion that the working capital available to the Issuer and the Guarantor respectively, is sufficient for the attainment of their objects and the carrying out of their respective business for the next twelve (12) months of operations.

9.2 The Guarantor

9.2.1 The Board of Directors of the Guarantor

The Memorandum of Association of the Guarantor provides that the board of directors shall be composed of not less than one (1) and not more than five (5) directors.

The only appointed Director of KA Holdings Ltd and Company Secretary is Kurt Abela. The Business Address of KA Holdings Ltd is "Project Technik", Cannon Road, Qormi Malta.

9.2.2 Directors' service contracts

None of the directors have a service contract with the Guarantor.

9.2.3 Removal of the Guarantor's directors

A director of the Guarantor may, unless he resigns, be removed by an ordinary resolution of the shareholders as provided by Article 140 of the Act. The directors of the Guarantor currently in office are expected to remain in office at least until the next annual general meeting of the Guarantor.

10 Major shareholders

10.1 Major shareholders of the Issuer

The Issuer has an authorised and issued share capital of €50,000 divided into 50,000 ordinary shares of a nominal value of €1 each which are subscribed to and allotted as fully paid shares, as follows:

| <i>Name of shareholder</i> | <i>Number of shares held</i> |
|-----------------------------------|-------------------------------------|
| <i>KAH limited</i> | 49,999 Ordinary shares |
| <i>Project Technik LTD</i> | 1 Ordinary share |

The Issuer adopts measures in line with the Code of Principles of Good corporate Governance forming part of the Listing Rules (the “Code”) with a view to ensuring the relationship with its major shareholders is retained at an arm’s length, including adherence to rules on related party transactions requiring the sanction of the Audit Committee, which is constituted in its majority by non-executive Directors, all of which are independent. Mr John Soler acts as Chairman of the board. The Audit Committee has the task of ensuring that any potential abuse is managed, controlled and resolved in the best interests of the Issuer. The composition of the Board, including the presence of two non-executive and independent Directors, effectively minimises the possibility of any abuse of control by the major shareholder.

10.2 Major shareholders of the Guarantor

The Guarantor’s current authorised and issued share capital is €150,000 divided into 150,00 ordinary shares of a nominal value of €1 each which are subscribed to and allotted as fully paid shares, as follows:

| <i>Name of shareholder</i> | <i>Number of shares held</i> |
|-----------------------------------|-------------------------------------|
| <i>Kurt Abela</i> | 149,999 Ordinary shares |
| <i>Project Technik</i> | 1 Ordinary share |

Therefore, the Guarantor is ultimately full owned by Mr Kurt Abela.

11 DIVIDEND POLICY

The Directors currently do not have a fixed dividend policy in place. The decision on whether the Group will declare a dividend will be determined by the Directors on an annual basis, subject to the Restrictive Covenants in Section 21.6.

12 Board Committees

12.1 Audit Committee

The Audit Committee will always be made up by a majority of Independent, Non-Executive Directors. The Chairman of the Audit Committee has to be appointed from amongst the Independent, Non-Executive Directors. Meetings of the Audit Committee shall only be held if a quorum of at least 2 members is satisfied.

In the case of an equality of votes during a meeting of the Board of Directors or Audit Committee, the Chairman thereof shall have a casting vote. However, where the Chairman is him/herself conflicted, the consideration of the relevant matter (in respect of which an interest has been declared) shall be chaired by another independent non-executive director or member (as the case may be), who shall also have a casting vote.

The terms of reference of the Audit Committee of the Issuer consist of offering its support to the Guarantor in its responsibilities in dealing with issues of risk, control and governance, and associated assurance.

The Board of Directors of the Issuer has set formal rules of establishment and the terms of reference of the Audit Committee that establish its composition, role and function, the parameters of its remit, as well as the basis for the processes that it is required to comply with. The Audit Committee, which meets at least once every three months, is a sub-committee of the board of the issuer and is directly responsible and accountable to the board of the issuer. The Board reserves the right to change the Committee's terms of reference from time to time, subject to the prior notification to the Exchange.

The terms of reference of the Audit Committee have been formally set out in a separate document. Briefly, the Audit Committee are expected to deal with and advise the Board on:

- a) its monitoring responsibility over the financial reporting processes, financial policies, internal control structures and audit of the annual and consolidated financial statements. The guarantor has the obligation of providing monthly management accounts;
- b) monitoring the performance of the entity borrowing funds (the Guarantor) from the Company;
- c) maintaining communications on such matters between the Board, management and the independent auditors;
- d) facilitating the independence of the external audit process and addressing issues arising from the audit process; and

- e) preserving the Issuer's assets by understanding the Issuer's risk environment and determining how to deal with those risks.

Additionally, the Audit Committee has the role and function of considering and evaluating the arm's length nature of any proposed transactions to be entered into by the Issuer/Guarantor and a related party, given the role and position of the Issuer/Guarantor within the Group, to ensure that the execution of any such transaction is, indeed, at arm's length and on a sound commercial basis and, ultimately, in the best interests of the Issuer/Guarantor. In this regard, the Audit Committee has the task of ensuring that any potential abuse which may arise in consequence of the foregoing state of affairs is immediately identified and resolved.

For this purpose, the Audit Committees have, pursuant to the relative terms of reference, been granted express powers to be given access to the financial position of the Issuer, the Guarantor, and all other entities forming part of the Group on at least a quarterly basis.

The Audit committee of KA finance Plc will be chaired by Etienne Borg Cardona, with John Soler and Kurt Abela being members of the same committee.

13 Compliance with Corporate Governance Requirements

13.1 The Issuer

The Issuer supports The Code of Principles of Good Corporate Governance annexed to the Listing Rules (the "Code") with the exceptions mentioned below and is confident that the adoption of the Code shall result in positive effects accruing to it. The Issuer adopts measures in line with the Code with a view to ensuring that all the transactions are carried out at arm's length.

The Board of Directors sets the strategy and direction of the Issuer and retains direct responsibility for appraising and monitoring the Issuer's financial statements and annual report. The activities of the Board are exercised in a manner designed to ensure that it can effectively supervise the operations of the Issuer so as to protect the interests of Bondholders, amongst other stakeholders. The Board is also responsible for making relevant public announcements and for the Issuer's compliance with its continuing obligations in terms of the Prospects MTF Rules.

As required by the Act and the Prospects MTF Rules, the Issuer's financial statements are to be subject to annual audit by the Issuer's external auditors. Moreover, the non-executive Directors will have direct access to the external auditors of the Issuer who attend Board meetings at which the Issuer's financial statements are approved. Moreover, in ensuring compliance with other statutory requirements and with continuing Prospects MTF admission obligations, the Board is advised directly, as appropriate, by its appointed Corporate Advisor and the external auditors. Directors are entitled to seek independent professional advice at any time on any aspect of their duties and responsibilities, at the Issuer's expense.

As at the date hereof, the Board considers the Issuer to be in compliance with the Code save for the following exceptions:

Principle 7: "Evaluation of the board's performance"

Under the present circumstances, the Board does not consider it necessary to appoint a committee to carry out a performance evaluation of its role, as the Board's performance is always under scrutiny of the shareholders of the Issuer.

Principle 8: "Committees"

The Board of Directors considers that the size and operation of the Issuer does not warrant the setting up of nomination and remuneration committees. Given that the Issuer does not have any employees other than the Directors and the company secretary, it is not considered necessary for the Issuer to maintain a remuneration committee. Also, the Issuer will not be incorporating a nomination committee. Appointments to the Board of Directors are determined by the

shareholders of the Issuer in accordance with the Issuer's Memorandum and Articles of Association. The Issuer considers that the members of the Board possess the level of skill, knowledge and experience expected in terms of the Code.

13.2 The Guarantor

The Guarantor is a private company, and accordingly, is not bound by the provision of the Code set out in the Listing Rules. Whilst the Guarantor is not required to adopt the provisions of the Code, the Audit Committee of the Issuer has been specifically tasked with keeping a watching brief over the financial performance of the Guarantor and any other Group subsidiaries, as well as ensuring that rules regarding related party transactions carried out with the Guarantor are adhered to at all times.

14 Litigation Proceedings

There have been no governmental, legal or arbitration proceedings (including any such proceedings which are pending or threatened of which the Issuer is aware about itself and the Guarantor) since incorporation of the Issuer and the Guarantor which may have, or have had, in the recent past significant effects on the financial position or profitability of the Issuer and the Guarantor.

15 Additional Information

15.1 Memorandum and articles of association of the Issuer

15.1.1 Incorporation

The Issuer was incorporated on 22nd April 2019 as a public limited company in terms of the Companies Act, 1995, with company registration number C91544.

In terms of Clause 3 of its Memorandum of Association, the Issuer is authorised to float its capital (including equity or debt) on Prospects MTF, and to borrow and raise funds through the issue of bonds.

The Memorandum and Articles of Association of the Issuer otherwise regulate matters customarily dealt with therein, including matters such as voting rights and restrictions thereof, and the appointment and powers of Directors, as elaborated upon in section 9 above.

15.1.2 Share capital

The Issuer has, as at the date hereof, an authorised and issued share capital of €50,000 divided into 50,000 ordinary shares of a nominal value of €1 each.

The shares of the Issuer are not admitted on Prospects MTF or listed on the Official List or the Alternative Companies list of the MSE, nor has an application ever been filed for the shares of the Issuer to be quoted on any trading platform. There is no capital of the Issuer which has been issued to the public as from the date of incorporation to date of the Company Admission Document, nor is it expected that the Issuer issues during the next financial year any shares to the public, whether fully or partly paid-up, in consideration for cash or otherwise. There is no capital of the Issuer which is currently under option, nor is there any agreement by virtue of which any part of the capital of the Issuer is to be put under option.

15.1.3 Objects

The Memorandum and Articles of Association of the Issuer are registered with the Registry of Companies, Malta. The objects of the Issuer include carrying on the business of a finance company thereby to lend and advance money or otherwise give credit, without limitation in such manner as the Issuer shall think fit and to invest and deal with the moneys in such manner as the Issuer shall think fit. The issue of bonds falls within the objects of the Issuer. Clause 3 of the Memorandum of Association contains the full list of objects of the Issuer.

The Memorandum and Articles of Association of the Issuer otherwise regulate matters customarily dealt with therein, including matters such as voting rights and restrictions thereof, and the appointment and powers of Directors.

A copy of the Memorandum and Articles of Association of the Issuer may be inspected during the lifetime of the Company Admission Document at the registered office of the Issuer as set out under the heading "Documents available for inspection" in section 18 of this Company Admission Document and at the Malta Registry of Companies during the lifetime of the Issuer.

15.1.4 Voting rights

In terms of the Memorandum of Association of the Issuer, all shares shall grant the right of one (1) vote for every share held and are participating shares entitled to receive dividend distributions as deemed fit by the Board of Directors and shall rank *pari passu* in all respects including dividend and capital repayment rights.

Holders of preference shares have the right to attend and vote at General Meetings except on a resolution:

- (a) for the purpose of reducing the capital of the Company; or
- (b) for the purpose of winding up of the Company; or
- (c) for the purpose of any proposal submitted to the meeting which directly affects their rights and privileges; or
- (d) for the purpose of affecting the dividend on preference shares when the dividend on their shares is in arrears for more than six (6) months.

Thus, preference shareholders are entitled to vote, where each preference share shall carry one vote.

15.2 Memorandum and articles of association of the Guarantor

15.2.1 Incorporation

The Guarantor was incorporated on 19 April 2012 as a public limited company in terms of the Companies Act, 1995, with company registration number C 56023.

15.2.2 Objects

The memorandum and articles of association of the Guarantor are registered with the Registry of Companies, Malta. The main objects of the Guarantor's activities are set out in Clause 3 of the memorandum of association, which include but are not limited to:

- I. Acquire investment, moveable or immovable and to deal in such investments;

- II. Provide to other companies any advisory, consultative, administrative and management services;
- III. Sell, take on lease, hire or otherwise acquire any moveable or immovable property;
- IV. Sell, give or otherwise dispose of the whole or any part of the business or property of the company for such consideration as the company may think fit;
- V. Acquire, in any manner valid at law, any kind of property, moveable or immovable, for use of the company and to dispose of any such property in any manner valid at law. This also to include the renting of immovable property;
- VI. Guarantee in favour of third parties, and to accept third party guarantees in favour of the company, in relation to any overdraft, loan or other arrangement, whereby the company or third parties are obliged to repay any sums of money in relation to such overdraft, loan or arrangements as the case may be;
- VII. Invest in any manner the funds of the company.

15.2.3 Share capital

The guarantor has an authorised and issued share capital of €150,000 divided into 150,000 ordinary shares of € 1 each.

15.2.4 Voting rights

All shares grant the right of one (1) vote for every share held and are participating shares entitled to receive dividend distributions as deemed fit by the board of directors of the Guarantor and rank *pari passu* in all respects including dividend and capital repayment rights.

15.2.5 Appointment of Directors

In terms of the memorandum and articles of association of the Guarantor, the directors shall be appointed in the general meeting of the Guarantor.

Further details on the appointment of directors of the Guarantor may be found in the memorandum and articles of association of the Guarantor, a copy of which may be inspected during the lifetime of the Company Admission Document at the registered office of the Guarantor and at the Registrar of Companies of the MFSA.

16 Material Contracts

On the 22nd of February 2019 the Guarantor has entered into a contract with Project Technik Ltd, being a related party. The Guarantor as at 31st December 2018 owed the related party eight hundred and twelve thousand three hundred and twenty Euro (€ 812,320).

The contract stipulates that the debt due is constituted of principal only and no interest was ever charged and will be charged by the creditor (related party) over the debt that is outstanding.

Furthermore, no payments can be made to the related party by the Guarantor before the 1st of January 2021.

The Guarantor shall have the right to make payments in respect to the related party loan from 1st January 2021 onwards as long as the Restrictive Covenants outlined in the Company Admission Document are respected, without any penalty or indemnity to the creditor. As outlined in the Restrictive Covenants, no payments can be done without these payments being fully approved and endorsed by the Board of Directors of KA Finance PLC.

Other from the contract mentioned above, the Issuer and the Guarantor have not entered into any material contracts which are not in the ordinary course of its business which could result in either the Issuer or the Guarantor being under an obligation or entitlement that is material to the Issuer's or Guarantor's ability to meet its obligations to Bondholders in respect of the Bonds being issued pursuant to, and described in, the Company Admission Document.

17 Third-Party Information, Statements by Experts and Declaration of Any Interest

17.1 Valuation reports

The Company commissioned Architect Ivan Bondin to issue a valuation report on the freehold value of the Properties. The business address of Architect Ivan Bondin is Triq il-Blata l-Kaħla, Santa Venera, SVR 1813.

Prospects MTF Rule 4.13.04.03 provides that property valuations to be included in a company admission document must not be dated (or be effective from) more than 60 days prior to the date of publication of the Company Admission Document. The valuation reports are dated 17th June, 2019

17.2 Accountants' report on prospective financial information

The Issuer engaged Kosco Management Services Limited (C-17184) a firm of Certified Public Accountants, to issue the Accountants' Report dated 24th July 2019. The following are the details of the said expert

Name: Kosco Management Services Limited

Address: "Kosco", G. Cali' Street, Ta Xbiex XBX1424

17.3 Interests of experts and advisers

Save for the valuation reports prepared in relation to the freehold value of the property and the accountants' report on the consolidated profit forecast, the Company Admission Document does not contain any statement or report attributed to any person as an expert.

The valuation report dated 6th May 2019 has been included in the form and context in which they appear with the authorisation of Architect Ivan Bondin of Triq il-Blata l-Kaħla, Santa Venera, SVR 1813, which has given and has not withdrawn his consent to the inclusion of such report herein. Architect Ivan Bondin does not have any material interest in the Company. The Company confirms that the valuation report has been accurately reproduced in the Company Admission Document

and that there are no facts of which the Company is aware that have been omitted and which would render the reproduced information inaccurate or misleading.

The accountants report dated 29th March 2019 has been included in the form and context in which they appear with the authorisation of Kosco Management Services Limited, which has given and has not withdrawn its consent to the inclusion of such report herein. Kosco Management Services Limited does not have any material interest in the Company. The Company confirms that the accountants report has been accurately reproduced in the Company Admission Document and that there are no facts of which the Company is aware that have been omitted and which would render the reproduced information inaccurate or misleading.

The Corporate Advisor, the Broker, the Lawyer, the Security Trustee and the Auditor are all independent to the Issuer, Guarantor and any related party of the Issuer.

18 Documents Available for Inspection

- a) Memorandum and Articles of Association of the Issuer;
- b) Memorandum and Articles of Association of the Guarantor;
- c) Audited statutory financial statements of the Guarantor for the years ended 31st December 2017 and 2018;
- d) the consolidated profit forecast and accountants' report for the years ending 31 December 2019, 2020; 2021; 2022 and 2023.
- e) Loan agreement between KA Holdings Ltd and Project Technik Ltd
- f) Loan agreements between Issuer and Guarantor on use of bond funds
- g) Insurance on Centris II
- h) Final Deed of Sale with regards the transfer of Centris II from PTL to KAH.
- i) Investment Management Policy
- j) Postponement of the General Hypothec by BOV with regards Centris II and KA Holdings Ltd.

19 Consent for Use of the Company Admission Document

As explained in section 2.1.2 of this Company Admission Document, the Secured Callable Bonds shall be made available for subscription by an authorised intermediary

For the purposes of any subscription for Secured Callable Bonds by the authorised intermediary pursuant and any subsequent resale, placement or other offering of Secured Callable Bonds by authorised intermediary, the Issuer consents to the use of this Company Admission Document (and accepts responsibility for the information contained therein) with respect to any such subsequent resale, placement or other offering of Secured Callable Bonds, provided this is limited only:

- a) in respect of Secured Callable Bonds subscribed for by the authorised intermediary
- b) to any resale, placement or other offering of Secured Callable Bonds subscribed for as aforesaid, taking place in Malta;
- c) to any resale or placement of Secured Callable Bonds taking place within the period of 60 days from the date of the Company Admission Document.

There are no other conditions attached to the consent given by the Issuer hereby which are relevant for the use of the Company Admission Document.

All information on the Terms and Conditions of the Secured Callable Bonds which is offered to any prospective investor by an authorised intermediary is to be provided by such authorised intermediary to the prospective investor prior to such investor subscribing to any Secured Callable Bonds. Any interested investor has the right to request that an authorised intermediary provide the investor with all and any information on the Company Admission Document, including the Terms and Conditions of the Secured Callable Bonds.

None of the Issuer, or any of their respective advisors take any responsibility for any of the actions of the Placement Agent and Manager including their compliance with applicable conduct of business rules or other local regulatory requirements or other securities law requirements in relation to a resale or placement of Bonds.

Other than as set out herein, neither the Issuer nor the Placement Agent and Manager has authorised (nor do they authorise or consent to the use of this Company Admission Document in connection with) the making of any public offer of the Secured Callable Bonds by any person in any circumstances. Any such unauthorised offers are not made on behalf of the Issuer or the Placement Agent and Manager and neither the Issuer nor the Placement Agent and Manager has any responsibility or liability for the actions of any person making such offers.

Prospective investors should enquire whether an intermediary is considered to be an authorised intermediary in terms of the Company Admission Document. If the prospective investor is in doubt

as to whether it can rely on the Company Admission Document and/or who is responsible for its contents, the investor should obtain legal advice in that regard.

No person has been authorised to give any information or to make any representation not contained in or inconsistent with this Company Admission Document. If given or made, it must not be relied upon as having been authorised by the Issuer or Placement Agent and Manager. The Issuer does not accept responsibility for any information not contained in this Company Admission Document.

In the event of a resale, placement or other offering of Secured Callable Bonds by the authorised intermediary said authorised intermediary shall be responsible to provide information to prospective investors on the terms and conditions of the resale, placement or other offering at the time such resale, placement or other offering is made.

Any resale, placement or other offering of Secured Callable Bonds to an investor by an authorised intermediary, will be made in accordance with any terms and other arrangements in place between such authorised intermediary and such investor including as to price, allocations and settlement arrangements. Where such information is not contained in the Company Admission Document, it will be the responsibility of the applicable authorised intermediary at the time of such resale, placement or other offering to provide the investor with that information and neither the Issuer nor the Placement Agent and Manager has any responsibility or liability for such information.

Any authorised intermediary using this Company Admission Document in connection with a resale, placement or other offering of Secured Callable Bonds subsequent to the Bond Issue shall, limitedly for the period of 60 days from the date of the Company Admission Document, publish on its website a notice to the effect that it is using this Company Admission Document for such resale, placement or other offering in accordance with the consent of the Issuer and the conditions attached thereto. The consent provided herein shall no longer apply following the lapse of such period.

20 Key Information

20.1 Estimated expenses and proceeds of the Issue

Professional fees and costs related to printing, admission, registration, management, registrar fees, selling commission and other miscellaneous costs incurred in connection with this Bond Issue, are estimated not to exceed €120,000 and shall be borne by the Issuer.

The amount of the expenses will be deducted from the proceeds of the Bond Issue, which, accordingly, will bring the estimated net proceeds from the Bond Issue to €5.88 million. There is no particular order of priority with respect to such expenses.

20.2 Reasons for the Issue and Use of Proceeds

The proceeds from the Bond Issue, which net of issue expenses are expected to amount to approximately €5,880,000 will be used by the Issuer for the following purposes in the following order of priority, and should the amount not be utilised in full, such additional proceeds will cascade to the following order of priority:

- a) A maximum amount of €2,000,000 of the proceeds from the Secured Callable bonds will be advanced under title of loan to the guarantor to be utilised for the purchase the land on which Centris II will be built upon. Further information provided in Section 8.1.4.1 and section 21.25.1
- b) An amount of €2,900,000 of the net proceeds from the Secured Callable Bonds will be advanced under title of loan to the Guarantor to be utilised in order to develop the Centris II property in Mriehel. This amount would cover all constructions and finishing works. Further information provided in Section 8.1.4.1;
- c) An amount of €800,000 of the proceeds from the Secured Callable Bonds will be advanced under title of loan to the Guarantor to be utilised to build and finish off the luxury apartments in Swieqi. Further information provided in Section 8.1.4.2;
- d) An amount of €180,000 of the proceeds from the Secured Callable Bonds will be advanced under title of loan to the Guarantor to build and finish off the Boutique Hotel in Gzira. Further information provided in Section 8.1.4.3.

In the event that the Issuer does not receive subscriptions for the full €6.0 million in Secured Callable Bonds, the Issuer will proceed with the admission of the amount of Secured Callable Bonds subscribed for, however, should the amount of Secured Callable Bonds subscribed for be less than €4.0 million, the Issuer will return the amount of Secured Callable Bonds subscribed for, to Bondholders. Any residual amounts required by the Issuer for the purposes of the uses specified in

this section which shall not have been raised through the Bond Issue, subject that the amount of Secured Callable Bonds subscribed for is not returned to Bondholders, shall be financed from the Group's general cash flow and/or bank financing.

21 Information Concerning the Secured Callable Bonds

21.1 Each Secured Callable Bond shall be issued subject to the Terms and Conditions set out in this Company Admission Document and by subscribing to or otherwise acquiring the Secured Callable Bonds, the Bondholders are deemed to have knowledge of all the Terms and Conditions of the Secured Callable Bonds hereafter described and to accept and be bound by the said Terms and Conditions.

21.2 General

21.2.1 Each Secured Callable Bond forms part of a duly authorised issue of 4.75% Secured Callable Bonds 2026-2029 of a nominal value of €100 per Bond issued by the Issuer at par up to the principal amount of €6.0 million (except as otherwise provided under section 21.16 "Further Issues" below).

21.2.2 The issue date of the Secured Callable Bonds is 9th August, 2019

21.2.3 The currency of the Secured Callable Bonds is Euro (€).

21.2.4 The Bonds are complex financial instruments and may not be suitable for all recipients of the Company Admission Document Prospective investors are urged to consult an independent investment advisor licensed under the Investment Services Act (Cap. 370 of the laws of Malta) as to the suitability or otherwise of an investment in the Bonds before making an investment decision. In particular, such advice should be sought with a view to ascertaining that each prospective investor:

- a) has sufficient knowledge and experience to make a meaningful evaluation of the Bonds, the merits and risks of investing in the Bonds and the information contained, or incorporated by reference, in the Company Admission Document or any applicable supplement;
- b) has sufficient financial resources and liquidity to bear all the risks of an investment in the Bonds, including where the currency for principal or interest payments is different from the prospective investor's currency;
- c) understands thoroughly the terms of the Bonds and is familiar with the behaviour of any relevant indices and financial markets; and
- d) is able to evaluate possible scenarios for economic, interest rate and other factors that may affect its investment and its ability to bear the applicable risks. The Secured Callable Bonds shall bear Interest at the rate of 4.75% per annum payable annually in arrears on 9th August

of each year, the first interest falling on 9th August 2020. Any Interest Payment Date which falls on a day other than a Business Day will be carried over to the next following day that is a Business Day.

- 21.2.5 Subject to admission of the Secured Callable Bonds to Prospects MTF, the Secured Callable Bonds are expected to be assigned ISIN: MT0002301209
- 21.2.6 Unless previously purchased and cancelled or redeemed on any of the early redemption dates, the bonds shall be redeemable at par on the redemption date.
- 21.2.7 The issue of the Secured Callable Bonds is made in accordance with the requirements of the Prospects MTF Rules.
- 21.2.8 The Secured Callable Bonds are expected to be admitted on the Prospects MTF List on the 14th August, 2019 and dealing is expected to commence on the 16th August, 2019
- 21.2.9 The Issuer reserves the right that should any Secured Callable Bonds be sold on the secondary market, such Secured Callable Bonds may be purchased by the Issuer, at the price they would be trading at the time, prior to the Secured Callable Bonds' Redemption Date.
- 21.2.10 All outstanding Secured Callable Bonds, not previously purchased and cancelled, shall be redeemed by the Issuer at par (together with interest accrued to the date fixed for redemption) on the Redemption Date.
- 21.2.11 Should any Application not be accepted, or be accepted for fewer Bonds than those applied for, the monies or the balance of the amount paid but not allocated will be returned by the Placement Agent and Manager without interest by direct credit into the Applicant's bank account as indicated by the Applicant in the Application Form within five (5) Business Days from the date of final allocation. Neither the Issuer nor the Placement Agent and Manager will be responsible for any charges, loss or delays in transmission of the refunds. In this regard, save as otherwise may be established by the applicable law, any monies returnable to Applicants may be retained pending clearance of the remittance and any verification of identity or compliance with customer acceptance policy as required by the PMLFT Regulations . Such monies will not bear interest while retained as aforesaid.
- 21.2.12 There are no special rights attached to the Secured Callable Bonds other than the right of the Bondholders to payment of capital and interest (as detailed below) and in accordance with the ranking specified in section 21.5 of this Company Admission Document.
- 21.2.13 The minimum subscription amount of Secured Callable Bonds that can be subscribed for by Applicants is €2,000, and in multiples of €100 thereafter.

21.2.14 The Bond Issue is not underwritten. In the event that the Bond Issue is not fully subscribed the Issuer will proceed with the admission of the amount of Secured Callable Bonds subscribed for, as long as the Minimum Amount is achieved

21.3 Subscription

The Issuer has entered into conditional subscription agreements with Curmi & Partners Ltd, the Placement Agent and Manager, for the subscription of the Secured Callable Bonds, whereby it will bind itself to allocate Secured Callable Bonds thereto up to the total amount of €6 million, subject to the Secured Callable Bonds being admitted to trading on the Prospects MTF. Interested investors may contact the Placement Agent and Manager for the purposes of subscribing to Bonds during the Issue Period. Applications for subscriptions to the Bonds will be processed on a first-come-first-served basis and the Issue Period shall close immediately upon attaining full subscription or on the last day of the Issue Period, whichever is the earliest.

The Bonds are open for subscription to all categories of investors, provided that the Placement Agent and Manager or other authorised financial intermediary shall be required to carry out an Appropriateness Test in respect of each Applicant for the purpose of assessing such Applicant's level of knowledge and experience prior to investing in the Bonds. Applications shall not be accepted by the Placement Agent and Manager unless, based on the results of such Appropriateness Test, the Placement Agent and Manager is satisfied that an investment in the Bonds may be considered appropriate for the Applicant. To the extent that the Placement Agent and Manager or other authorised financial intermediary is providing advice in respect of a purchase of the Bonds by an Applicant, the Placement Agent and Manager or other authorised financial intermediary shall also be required to conduct a Suitability Test in respect of the Applicant and, based on the results of such test, be satisfied that an investment in the Bonds may be considered suitable for the Applicant. Prospective investors should be aware of the potential risks in investing in the Bonds after careful evaluation of all the risk factors involved, and should consider making the decision to invest after consideration with his/her own independent financial advisor. The authorised financial intermediary subscribing for Bonds may do so for their own account or for the account of underlying customers, including retail customers, and shall, in addition, be entitled to distribute any portion of the Secured Callable Bonds subscribed for upon commencement of trading. In any case the Placement Agent and Manager shall ensure that subscribers to the Bonds are duly warned about the Risk Factors involved with investing in the Bonds and subscribers shall confirm that they have been so warned.

The Bond Issue is not underwritten. Should subscriptions for a total of at least €4,000,000 (the "Minimum Amount") not be received, no allotment of the Bonds shall be made, the Applications for Bonds shall be deemed not to have been accepted by the Issuer and all money received from Applicants for Bonds shall be refunded accordingly. In the event that the Minimum Amount is reached but the Bond Issue is still not fully subscribed, the Issuer will proceed with the allotment of the amount of Bonds subscribed.

The total amount of six million Euro (€6,000,000) of Bonds is being reserved for subscription by the Placement Agent and Manager participating in the Placement Offer. The Issuer shall enter into a conditional subscription agreement with the Placement Agent and Manager for the subscription

of Bonds, whereby it will bind itself to allocate Bonds thereto up to the total amount of six million Euro (€6,000,000) as aforesaid.

In terms of said subscription agreement entered into with the Placement Agent and Manager, the Issuer will be conditionally bound to issue, and the Placement Agent and Manager will be conditionally bound to subscribe to, up to the total amount of six million Euro (€6,000,000) of Bonds as indicated therein, each subject to the Minimum Amount of €4,000,000 being subscribed.

For the purpose of this Company Admission Document, the term "Suitability Test" means the process through which a licensed financial intermediary providing investment advice or portfolio management services in relation to the subscription for and trading of Bonds, obtains such information from the Applicant or prospective transferee, as is necessary, to enable the licensed financial intermediary to recommend to or, in the case of portfolio management, to effect for, the Applicant or prospective transferee, the investment service and trading in Bonds that are considered suitable for him/her, in accordance with Part BI of the Investment Services Rules for Investment Services Providers issued by MFSA. The information obtained pursuant to this test must be such as to enable the licensed financial intermediary to understand the essential facts about the Applicant or prospective transferee and to have a reasonable basis for believing, giving due consideration to the nature and extent of the service provided, that the specific transaction to be recommended, or to be entered into in the course of providing a portfolio management service, satisfies the following criteria:

- it meets the investment objectives of the Applicant or prospective transferee in question;
- it is such that the Applicant or prospective transferee is able financially to bear any related investment risks consistent with the investment objectives of such Applicant or prospective transferee; and
- it is such that the Applicant or prospective transferee has the necessary experience and knowledge in order to understand the risks involved in the transaction or in the management of his portfolio.

21.4 Status and Ranking of the Secured Callable Bonds

Subject to any other privileged or prior ranking debt according to law, the Secured Callable Bonds are secured by the Collateral/Security as described in section 21.25 shall constitute the general, direct and unconditional obligations of the Company, guaranteed by the Guarantor, and shall at all times rank *pari passu*, without any priority or preference among themselves, but with priority over any other unsecured debt of each of the Company and the Guarantor, if any. The Special Hypothec agreements shall constitute a preferential claim in favour of the Security Trustee for the benefit of the Bondholders in the event of any claim against the Company or the Guarantor for any payment of any interest or of the principal amount.

The group has the below bank debt in the name of KA Holdings Ltd as at 31st December, 2018:-

| Bank | Amount | Type of Facility | Security |
|------------------|------------|------------------|--|
| Bank of Valletta | €1,982,553 | Bank Loan | Special Hypothec on Centris I and a general hypothec on all assets |

A postponement of the General Hypothec was issued by BOV in favour of KA Trust on the 17th July, 2019

21.5 Rights attaching to the Secured Callable Bonds

There are no special rights attached to the Secured Callable Bonds other than the right of the Bondholders to:

- i. the payment of interest;
- ii. the payment of capital as and when due;
- iii. qualify as primary beneficiary of the Security Trust and thereby to benefit from the Collateral through the Security Trustee in accordance with the terms of the Security Trust Deed;
- iv. attend, participate in and vote at meetings of Bondholders in accordance with the Terms and Conditions of the Bond Issue; and
- v. enjoy all such other rights attached to the Secured Callable Bonds emanating from the Company Admission Document.

21.6 Restrictive covenants

Restricted Payments

Neither the Issuer or the Guarantor shall:

- (i) declare or make any dividend payments
- (ii) make any repayments towards any outstanding related party loan

(any such payment as set forth in (i) and (ii) above referred to as a Restricted Payment) until after the financial year ending 31st December 2020.

Furthermore, in the financial years following the financial year ending 31st December 2020, for as long as any principal or interest under the Secured Callable Bonds remain outstanding, the Guarantor shall not make any Restricted Payment unless:

- The Interest Cover Ratio calculated on the basis of the most recent audited consolidated financial statements of the Guarantor, adjusted to take into consideration the proposed Restricted Payment, is not below 2.0x;
- The Debt-to-Total Capital Ratio calculated on the basis of the most recent audited consolidated financial statements of the Guarantor, adjusted to take into consideration the proposed Restricted Payment, is below 60%; and
- The Restricted Payment is approved and endorsed by the Board of Directors of the Issuer, KA Finance PLC.

Permitted indebtedness

The Guarantor shall not, for as long as any principal or interest under the Secured Callable Bonds remain outstanding, incur or guarantee any "Financial Indebtedness", unless:

- The Interest Cover Ratio calculated on the basis of the most recent audited consolidated financial statements of the Guarantor, adjusted to take into consideration the proposed incurrence of additional Financial Indebtedness, is not below 2.0x;
- The Debt-to-Total Capital Ratio calculated on the basis of the most recent audited consolidated financial statements of the Guarantor, adjusted to take into consideration the proposed incurrence of additional Financial Indebtedness, is below 60%; and
- The Financial Indebtedness is approved and endorsed by the Board of Directors of the Issuer, KA Finance PLC.

"Financial Indebtedness" means any indebtedness in respect of:

- (a) monies borrowed;
- (b) any debenture, bond, note, loan stock or other security;
- (c) any acceptance credit;
- (d) the acquisition cost of any asset to the extent payable before or after the time of acquisition or possession by the party liable where the advance or deferred payment is arranged primarily as a method of raising finance for the acquisition of that asset;
- (e) leases entered into primarily as a method of raising finance for the acquisition of the asset leased;
- (f) amounts raised under any other transaction having the commercial effect of borrowing or raising of money;
- (g) any guarantee, indemnity or similar assurance against financial loss of any person;

Negative Pledge

Neither the Issuer nor the Guarantor shall, for as long as any principal or interest under the Secured Callable Bond remain outstanding, create any liability or financial indebtedness which is secured by the Collateral that may have the effect of diminishing the Collateral which is securing the interest of the bond holders.

21.7 Interest

21.7.1 The Secured Callable Bonds shall bear Interest from and including 9th August, 2019 at the rate of 4.75% per annum on the nominal value thereof, payable annually in arrears on each Interest Payment Date. The first Interest payment will be effected on 9th August, 2020 (covering the period 9th August, 2019 to 8th August, 2020). Any Interest Payment Date which falls on a day other than a Business Day will be carried over to the next following day that is a Business Day. Each Secured Callable Bond will cease to bear Interest from and including its due date for redemption, unless payment of the principal in respect of the Secured Callable Bond is improperly withheld or refused or unless default is otherwise made in respect of payment, in any of which events Interest shall continue to accrue at the highest rate applicable by law .In terms of article 2156 of the Civil Code (Cap. 16 of the laws of Malta), the right of Bondholders to bring claims for payment of interest and repayment of the principal on the Secured Callable Bonds is barred by the lapse of five (5) years.

21.7.2 When interest is required to be calculated for any period of less than a full year, it shall be calculated on the basis of a three hundred and sixty (360) day year consisting of twelve (12) months of thirty (30) days each, and in the case of an incomplete month, the number of days elapsed.

21.8 Yield

21.8.1 The gross yield calculated on the basis of the Interest, the Bond Issue Price and the Redemption Value of the Secured Callable Bonds at Redemption Date is 4.75%.

21.9 Registration, Form, Denomination and Title

- 21.9.1 Certificates will not be delivered to Bondholders in respect of the Secured Callable Bonds in virtue of the fact that the entitlement to Secured Callable Bonds will be represented in an uncertificated form by the appropriate entry in the electronic register maintained on behalf of the Issuer by the CSD. There will be entered in such electronic register the names, addresses, identity card numbers (in the case of natural persons), registration numbers (in the case of body corporates) LEI (Legal Entity Identifier) and MSE account numbers of the Bondholders and particulars of the Secured Callable Bonds held by them respectively; and the Bondholders shall have, at all reasonable times during business hours, access to the register of Bondholders held at the CSD for the purpose of inspecting information held on their respective account.
- 21.9.2 The CSD will issue, upon a request by a Bondholder, a statement of holdings to such Bondholder evidencing his/her/its entitlement to Secured Callable Bonds held in the register kept by the CSD in accordance with the MSE's applicable terms and conditions.
- 21.9.3 Upon submission of an Application Form, Bondholders who opt to subscribe for the online e-portfolio account with the CSD, by marking the appropriate box on the Application Form, will be registered by the CSD for the online e-portfolio facility and will receive by mail at their registered address a handle code to activate the new e-portfolio login. The Bondholder's statement of holdings evidencing entitlement to Secured Callable Bonds held in the register kept by the CSD and registration advices evidencing movements in such register will be available through the said e-portfolio facility on <https://eportfolio.borzamalta.com.mt/>. Further detail on the e-portfolio is found on <https://eportfolio.borzamalta.com.mt/Help>.
- 21.9.4 The Secured Callable Bonds will be issued in fully registered form, in denominations of any integral multiple of €100 per Bond, provided that on subscription the Secured Callable Bonds will be issued for a minimum of €2,000 per individual Bondholder. Authorised intermediary subscribing to the Secured Callable Bonds through nominee accounts for and on behalf of clients shall apply the minimum subscription amount of €2,000 to each underlying client.
- 21.9.5 Any person in whose name a Secured Callable Bond is registered, may (to the fullest extent permitted by applicable law) be deemed and treated at all times, by all persons and for all purposes (including the making of any payments), as the absolute owner of such Secured Callable Bond. Title to the Secured Callable Bonds may be transferred as provided below under the heading "Transferability of the Secured Callable Bonds" in section 21.15 of the Company Admission Document.

21.10 Pricing

The Secured Callable Bonds are being issued at par, that is, at €100 per Bond.

21.11 Payments

- 21.11.1 Payment of the principal amount of the Secured Callable Bonds will be made in Euro by the Issuer to the person in whose name such Secured Callable Bonds are registered, with interest accrued up to the Redemption Date, by means of direct credit transfer into such bank account as the Bondholder may designate from time to time. Upon payment of the Redemption Value, the Secured Callable Bonds shall be redeemed and the appropriate entry shall be made in the electronic register of the Secured Callable Bonds at the CSD.
- 21.11.2 In the case of Secured Callable Bonds held subject to usufruct, payment of interests will be made against the joint instructions of all bare owners and usufructuaries. Before effecting payment, the Issuer and/or the CSD shall be entitled to request any legal documents deemed necessary concerning the entitlement of the bare owner/s and the usufructuary/ies to payment of the Secured Callable Bonds.
- 21.11.3 Payment of interest on a Secured Callable Bond will be made to the person in whose name such Secured Callable Bond is registered at the close of business fifteen (15) days prior to the Interest Payment Date, by means of a direct credit transfer into such bank account as the Bondholder may designate, from time to time. Such payment shall be effected within seven (7) days of the Interest Payment Date. The Issuer shall not be responsible for any charges, loss or delay in transmission.
- 21.11.4 All payments with respect to the Secured Callable Bonds are subject in all cases to any pledge (duly constituted) and to any applicable fiscal or other laws and regulations prevailing in Malta. In particular, but without limitation, all payments of principal and Interest by or on behalf of the Issuer in respect of the Secured Callable Bonds shall be made net of any amount which the Issuer is compelled by law to deduct or withhold for or on account of any present or future taxes, duties, assessments or other government charges of whatsoever nature imposed, levied, collected, withheld or assessed by or within the Republic of Malta or any authority thereof or therein having power to tax.
- 21.11.5 No commissions or expenses shall be charged by the Issuer to the Bondholders in respect of payments made in accordance with this section 21.12. The Issuer shall not be liable for charges, expenses and commissions levied by parties other than the Issuer.

21.12 Redemption and Purchase

21.12.1 Unless previously purchased and cancelled, the Issuer hereby irrevocably covenants in favour of each Bondholder that the Secured Callable Bonds will be redeemed at their nominal value (together with accrued interest) on 9th August, 2029, provided that the Issuer reserves the right to redeem all the bond on any one of the early redemption dates at prices according to the Early Repayment Schedule. The Issuer shall give at least 60 days notice in writing to all bondholders of its intention to effect such early redemption. In such a case the Issuer shall be discharged of any and all payment obligations under the Bonds upon payment made net of any withholding or other taxes due or which may be due under Maltese Law and which is payable by the Bondholders.

21.12.2 Subject to the provisions of this section 21.12, the Issuer may at any time purchase Secured Callable Bonds in the open market or otherwise at any price. Any purchase by tender shall be made available to all Bondholders alike.

21.12.3 All Secured Callable Bonds so redeemed or purchased will be cancelled forthwith and may not be re-issued or re-sold.

21.13 Events of Default

Pursuant to the Security Trust Deed, the Security Trustee may in its absolute and unfettered discretion, and shall upon the request in writing of not less than 60% in value of the Bondholders qua primary beneficiaries and/or of the Corporate Advisor appointed under the Prospects MTF Rules and acting in its duty of care to the Exchange, the market and the Bondholders, by notice in writing to the Issuer and the Guarantor and copied to the Security Trustee, declare the Secured Callable Bonds to have become immediately due and repayable at their principal amount, together with any accrued interest, if any of the following events ("Events of Default") shall occur:

- I. the Issuer and/or Guarantor shall fail to pay any Interest on any Secured Callable Bond when due and such failure shall continue for thirty (30) days after written notice thereof shall have been given to the Issuer and/or Guarantor, by the Security Trustee; and/or
- II. the Issuer shall fail duly to perform or shall otherwise be in breach of any other material obligation contained in the Terms and Conditions of the Secured Callable Bonds and such failure shall continue for sixty (60) days after written notice thereof shall have been given to the Issuer by any Bondholder; and/or
- III. in terms of article 214(5) of the Act, a Court order or other judicial process is levied or enforced upon or sued out against any part of the property of the Issuer and is not paid out, withdrawn or discharged within one month; and/or

- IV. the Issuer stops payment of its debts or ceases or threatens to cease to carry on its business; and/or
- V. the Issuer or the Guarantor is unable to pay its debts within the meaning of article 214(5) of the Act, or any statutory modification or re-enactment thereof; and/or
- VI. a judicial or provisional administrator is appointed upon the whole or any part of the property of the Issuer or the Guarantor; and such appointment is certified by the Security Trustee to be prejudicial, in its opinion, to the Bondholders; and/or
- VII. the Issuer or the Guarantor substantially changes the object or nature of its business as currently carried on; and/or
- VIII. the Issuer or the Guarantor commits a breach of any of the covenants or provisions contained in the trust deed and/or Guarantee and on its part to be observed and performed and the said breach still subsists for 30 days after having been notified by the Security Trustee (other than any covenant for the payment of interests or principal monies owing in respect of the Secured Callable Bonds); and/or
- IX. the security constituted by any hypothec or charge upon the whole or any part of the undertaking or assets of the Issuer or the Guarantor shall become enforceable and steps are taken to enforce the same and the taking of such steps shall be certified in writing by the Security Trustee to be in its opinion prejudicial to the Bondholders; and/or
- X. any representation or warranty made or deemed to be made or repeated by or in respect of the Issuer or the Guarantor is or proves to have been incorrect in any material respect in the sole opinion of the Security Trustee; and/or
- XI. any material indebtedness of the Issuer or the Guarantor is not paid when properly due or becomes properly due and payable or any creditor of the Issuer or the Guarantor (as the case may be) becomes entitled to declare any such material indebtedness properly due and payable prior to the date when it would otherwise have become properly due or any guarantee or indemnity of the Issuer or the Guarantor in respect of indebtedness is not honoured when properly due and called upon; provided that for the purposes of this provision, material indebtedness shall mean an amount exceeding €500,000; and/or
- XII. it becomes unlawful at any time for the Issuer or the Guarantor to perform all or any of its obligations hereunder or to develop the Group's Projects and/or hostel or to continue with the development of these Projects and/or hostel; and/or
- XIII. the Issuer or the Guarantor repudiates, or does or causes or permits to be done any act or thing evidencing an intention to repudiate the Secured Callable Bonds and/or the Guarantee; and/or
- XIV. all, or in the sole opinion of the Security Trustee, a material part, of the undertakings, assets, rights, or revenues of or shares or other ownership interests in the Issuer or the Guarantor are seized, nationalised, expropriated or compulsorily acquired by or under the authority of any government; and/or

- XV. there shall have been entered against the Issuer a final judgement by a court of competent jurisdiction from which no appeal may be or is made for the payment of money in excess of one million Euro (€1,000,000) or its equivalent and ninety (90) days shall have passed since the date of entry of such judgement without its having been satisfied or stayed;

Upon any such declaration being made as aforesaid the said principal monies and interest accrued under the Secured Callable Bonds shall be deemed to have become immediately payable at the time of the event which shall have happened as aforesaid.

Provided that in the event of any breach by the Issuer of any of the covenants, obligations or provisions herein contained due to any fortuitous event of a calamitous nature beyond the control of the Issuer, then the Security Trustee may, but shall be under no obligation so to do, give the Issuer such period of time to remedy the breach as in its sole opinion may be justified in the circumstances and if in its sole opinion the breach is remediable within the short term and without any adverse impact on the Bondholders. Provided further that in the circumstances contemplated by this proviso, the Security Trustee shall at all times act on and in accordance with any instructions it may receive in a meeting of Bondholders satisfying the conditions set out in the Security Trust Deed. The Security Trustee shall not be bound to take any steps to ascertain whether any Event of Default or other condition, event or circumstance has occurred or may occur, and, until it shall have actual knowledge or express notice to the contrary, the Security Trustee shall be entitled to assume that no such Event of Default or condition, event or other circumstance has happened and that the Issuer and/or Guarantor are observing and performing all the obligations, conditions and provisions on their respective parts contained in the Company Admission Document, the Guarantee and the Security Trust Deed. Provided further that, in the event that the Security Trustee becomes aware of the fact that an Event of Default has occurred or is likely to occur, it shall notify in writing the Malta Stock Exchange, the Corporate Advisor and the Bondholders of such fact without delay.

21.14 Transferability of the Secured Callable Bonds

- 21.14.1 The Secured Callable Bonds are freely transferable and, once admitted to the Prospects MTF, shall be transferable only in whole (in multiples of €100) in accordance with the rules and regulations of Prospects MTF and the MSE applicable from time to time. If Secured Callable Bonds are transferred in part, such attempted partial transfer will not be cleared and the transferee thereof will not be registered as a Bondholder or claim from the Issuer any purported benefit therefrom.
- 21.14.2 Any person becoming entitled to a Secured Callable Bond in consequence of the death or bankruptcy of a Bondholder may, upon such evidence being produced as may, from time to time, properly be required by the Issuer or the CSD, elect either to be registered himself as holder of the Secured Callable Bond or to have some person nominated by him registered as the transferee thereof. If the person so becoming entitled shall elect to be registered himself, he shall deliver or send to the CSD any and all documentation required in furtherance to his election in accordance with CSD rules and procedures. If he shall elect to have another person registered he shall testify his election by transferring the Secured Callable Bond, or procuring the transfer of the Secured Callable Bond, in favour of that person. Provided always that if a Secured Callable Bond is transmitted in furtherance of this paragraph, a person will not be registered as a Bondholder unless such transmission is made in multiples of €100.
- 21.14.3 All transfers and transmissions are subject in all cases to any pledge (duly constituted) of the Secured Callable Bonds and to any applicable laws and regulations.
- 21.14.4 The cost and expenses of effecting any registration of transfer or transmission, except for the expenses of delivery by any means other than regular mail (if any) and except, if the Issuer shall so require, the payment of a sum sufficient to cover any tax, duty or other governmental charge that may be imposed in relation thereto, will be borne by the person to whom the transfer/transmission has been made.
- 21.14.5 The Issuer will not register the transfer or transmission of Secured Callable Bonds for a period of fifteen (15) days preceding the Interest Payment Date or the due date for redemption.

21.15 Further Issues

21.15.1 The Issuer may, from time to time, without the consent of the Bondholders, create and issue further debentures, debenture stock, bonds, loan notes or any other debt securities, either having the same terms and conditions as any outstanding debt securities of any series (including the Secured Callable Bonds) and so that such further issue shall be consolidated and form a single series with the outstanding debt securities of the relevant series (including the Secured Callable Bonds), or upon such terms as the Issuer may determine at the time of their issue.

21.16 Meetings of Bondholders

21.16.1 The Issuer may, through the Security Trustee, from time to time, call meetings of Bondholders for the purpose of consultation with Bondholders or for the purpose of any of the following: (i) considering and approving any matter affecting their interest, including the amendment, modification, waiver, abrogation or substitution of any of the Terms and Conditions of the Secured Callable Bonds and the rights of the Bondholders arising under the Company Admission Document, subject to the prior written approval of the Exchange until such time that the Bonds remain admitted on any of its markets; (ii) considering and approving the exchange or substitution of the Secured Callable Bonds by, or the conversion of the Secured Callable Bonds into, shares, debentures or other obligations or securities of the Issuer; and (iii) obtaining the consent of Bondholders on other matters which in terms of the Company Admission Document require the approval of a Bondholders' meeting.

21.16.2 A meeting of Bondholders shall be called by the Directors by giving the Security Trustee not less than 21 days' notice in writing. Upon receiving due notice from the Directors, the Security Trustee shall call such meeting by giving all Bondholders listed on the register of Bondholders as at a date being not more than thirty (30) days preceding the date scheduled for the meeting, not less than fourteen (14) days' notice in writing. Such notice shall set out the time, place and date set for the meeting and the matters to be discussed or decided thereat, including, if applicable, sufficient information on any amendment of the Company Admission Document that is proposed to be voted upon at the meeting and seeking the approval of the Bondholders, subject to the prior written approval of the Exchange until such time that the Bonds remain admitted on any of its markets. Following a meeting of Bondholders held in accordance with the provisions contained hereunder, the Issuer shall, acting in accordance with the resolution(s) taken at the meeting, communicate to the Bondholders whether the necessary consent to the proposal made by the Issuer has been granted or withheld. Subject to having obtained the necessary approval by the Bondholders in accordance with the provisions of this section at a meeting called for that purpose as aforesaid, any such decision shall subsequently be given effect to by the Issuer.

- 21.16.3 The amendment or waiver of any of the Terms and Conditions of Issue of the Secured Callable Bonds may only be made with the approval of Bondholders at a meeting called and held for that purpose in accordance with the terms hereof, subject to the prior written approval of the Exchange until such time that the Bonds remain admitted on any of its markets.
- 21.16.4 A meeting of Bondholders shall only validly and properly proceed to business if there is a quorum present at the commencement of the meeting. For this purpose, at least two (2) Bondholders present, in person or by proxy, representing not less than 75% in nominal value of the Secured Callable Bonds then outstanding, shall constitute a quorum. If a quorum is not present within thirty (30) minutes from the time scheduled for the commencement of the meeting as indicated on the notice convening same, the meeting shall stand adjourned to a place, date and time as shall be communicated by the Directors to Bondholders present at that meeting. The Issuer shall within two (2) days from the date of the original meeting publish by way of a company announcement the date, time and place where the adjourned meeting is to be held, together with a warning about the new quorum at such adjourned meeting. An adjourned meeting shall be held not earlier than seven (7) days, and not later than fifteen (15) days, following the original meeting. At an adjourned meeting the number of Bondholders present at the commencement of the meeting, in person or by proxy, shall constitute a quorum; and only the matters specified in the notice calling the original meeting shall be placed on the agenda of, and shall be discussed at, the adjourned meeting.
- 21.16.5 Any person who in accordance with the Memorandum and Articles of Association of the Issuer is to chair the annual general meetings of shareholders shall also chair meetings of Bondholders.
- 21.16.6 Once a quorum is declared present by the chairman of the meeting, the meeting may then proceed to business and address the matters set out in the notice convening the meeting. In the event that decisions are required to be taken at the meeting, the Directors or their representative shall present to the Bondholders the reasons why it is deemed necessary or desirable and appropriate that a particular decision is taken. The meeting shall allow reasonable and adequate time to Bondholders to present their views to the Issuer and the other Bondholders present at the meeting. The meeting shall then put the matter as proposed by the Issuer to a vote of Bondholders present at the time at which the vote is being taken, and any Bondholders taken into account for the purpose of constituting a quorum who are no longer present for the taking of the vote shall not be taken into account for the purpose of such vote.
- 21.16.7 The voting process shall be managed by the Issuer's Company Secretary under the supervision and scrutiny of the auditors of the Issuer and the Security Trustee.
- 21.16.8 The proposal placed before a meeting of Bondholders shall only be considered approved if at least sixty per cent (60%) in nominal value of the Bondholders present at the meeting at the time when the vote is being taken, in person or by proxy, shall have voted in favour of the proposal.

21.16.9 Save for the above, the rules generally applicable to proceedings at general meetings of shareholders of the Issuer shall *mutatis mutandis* apply to meetings of Bondholders.

21.17 Authorisations and Approvals

The Directors authorised the Bond Issue and the publication of the Company Admission Document pursuant to a board of directors' resolution passed on 2nd May, 2019. The Guarantee being given by the Guarantor in respect of the Secured Callable Bonds has been authorised by a resolution of the board of directors of the Guarantor dated 2nd May, 2019.

21.18 Admission to Trading

21.18.1 Application has been made to the Malta Stock Exchange for the Secured Callable Bonds being issued pursuant to the Company Admission Document to be admitted and traded on its Prospects MTF.

21.18.2 The Secured Callable Bonds are expected to be admitted to the Malta Stock Exchange with effect from 14th August, 2019 and trading is expected to commence on 16th August, 2019. Dealing may commence prior to notification of the amount allocated being issued to Applicants.

21.19 Representations and Warranties

21.19.1 The Issuer represents and warrants to Bondholders and to the Security Trustee for the benefit of Bondholders, who shall be entitled to rely on such representations and warranties, that:

- I. it is duly incorporated and validly existing under the laws of Malta and has the power to carry on its business as it is now being conducted and to hold its property and other assets under legal title; and
- II. it has the power to execute, deliver and perform its obligations under the Company Admission Document and that all necessary corporate, shareholder and other actions have been duly taken to authorise the execution, delivery and performance of the same, and further that no limitation on its power to borrow or guarantee shall be exceeded as a result of the Terms and Conditions or the Company Admission Document.

21.19.2 The Company Admission Document contains all relevant material information with respect to the Issuer and Guarantor and all information contained in the Company Admission Document is in every material respect true and accurate and not misleading, and there are no other facts in relation to the Issuer and/or Guarantor, their respective business and financial position, the omission of which would, in the context of issue of the Secured Callable Bonds, make any statement in the Company Admission Document misleading or inaccurate in any material respect.

21.20 Secured Callable Bonds held jointly

In respect of any Secured Callable Bonds held jointly by several persons (including spouses), the joint holders shall nominate one (1) of their number as their representative and his/her name will be entered in the register with such designation. By default, the person whose name shall be inserted in the field entitled "Applicant" on the Application Form, or the first named in the register of Bondholders shall, for all intents and purposes, be deemed to be such nominated person by all those joint holders. Such person shall, for all intents and purposes, be deemed to be the registered holder of the Secured Callable Bond/s so held.

21.21 Secured Callable Bonds held subject to usufruct

In respect of a Secured Callable Bond held subject to usufruct, the name of the bare owner and the usufructuary shall be entered in the register. The usufructuary shall, for all intents and purposes, be deemed vis-a-vis the Issuer to be the holder of the Secured Callable Bond/s so held and shall have the right to receive interest on the Secured Callable Bond/s and to vote at meetings of the Bondholders but shall not, during the continuance of the Secured Callable Bond/s, have the right to dispose of the Secured Callable Bond/s so held without the consent of the bare owner, and shall not be entitled to the repayment of principal on the Secured Callable Bond (which shall be due to the bare owner, subject to the right of the usufructuary).

21.22 Governing law and jurisdiction

21.22.1 The Secured Callable Bonds are governed by and shall be construed in accordance with Maltese Law.

21.22.2 Any legal action, suit or proceedings against the Issuer and/or Guarantor and arising out of or in connection with the Secured Callable Bonds and/or the Company Admission Document shall be brought exclusively before the Maltese courts.

21.23 Notices

Notices will be mailed to Bondholders at their registered addresses and shall be deemed to have been served at the expiration of twenty-four (24) hours after the letter containing the notice is posted, and in proving such service it shall be sufficient to prove that a prepaid letter containing such notice was properly addressed to such Bondholder at his/her/its registered address and posted.

21.24 Sinking Fund

The Issuer hereby undertakes that as from the financial year ending 31st December 2025 it shall, over a period of four (4) years, build a Sinking Fund the value of which will by the Redemption Date be equivalent to 50% of the value of the issued Secured Callable Bonds. The Issuer shall primarily use the Sinking Fund to repay the Secured Callable Bonds on the Redemption Date or in any other manner in accordance with this Company Admission Document. The Issuer shall make periodic payments for the purpose of building up this Sinking Fund. Below is a table with the minimum amounts to be paid by the Issuer for this purpose:

Sinking fund contribution as at

| €000 | 2025 | 2026 | 2027 | 2028 | 2029 |
|----------------------------|------|------|------|------|------|
| <i>Annual contribution</i> | 750 | 750 | 750 | 750 | 0 |
| <i>Cumulative balance</i> | 750 | 1500 | 2250 | 3000 | 3000 |

The sinking fund shall be managed by the Issuer and administered by its Board of Directors.

The functions of the Board of Directors in relation to the administration of the Sinking Fund shall include the following activities:

- I. take control of the assets of the Sinking Fund which shall be segregated from the other assets of the Issuer;
- II. monitor the Issuer's obligation to effect yearly payments to the Sinking Fund;
- III. seek to ensure that by Redemption Date, the Sinking Fund would have accumulated 50% of the nominal amount of the Bonds still outstanding. In the event of a shortfall, the Board of Directors are to ensure that such discrepancy, caused by the Issuer, would be due to justifiable reasons;
- IV. ensure that the sinking fund is held in term deposits placed with the major retail commercial banks in Malta.

The Issuer may not create or permit to subsist security over the Sinking Fund assets, other than the creation of a general hypothec or privilege with a credit institution in the event that the Issuer is

facing temporary liquidity problems. Prior to the utilisation of the Sinking Fund assets for such temporary use, approval by the Board of Directors of the Issuer shall be required.

The Issuer shall be the primary beneficiary of the Sinking Fund, whereas the Security Trustee, in its capacity as trustee of the KA Trust, shall be identified as a secondary beneficiary. Upon the occurrence of any of the Events of Default, the secondary beneficiary shall be granted priority rights over the Sinking Fund, such that its entitlement to the Sinking Fund shall rank prior to that of the primary beneficiary and the Board of Directors shall make the necessary arrangements to safeguard the right of the Security Trustee to take ownership of the Sinking Fund making the necessary distribution of the Sinking Fund to the Security Trustee in its capacity as trustee of the KA Trust.

The Issuer shall on a half-yearly basis, in its interim and annual financial statements, explain the Issuer's compliance with the Sinking Fund requirements and if necessary explain the reasons for non-compliance, if any. The Bondholders will be informed on the publication of the said financial statements through the issuance of a company announcement by the Issuer. The financial information will be available for inspection at the registered office of the Issuer and in electronic form on the Guarantor's website www.kaholdings.com.mt

21.25 Security Trust

The obligation of the Issuer to the Bondholders under the Bond shall be Secured Callable by the Security Trust which shall have the benefit of the following security interests:

- (a) the Special Hypothec
- (b) the General Hypothec
- (c) Guarantee
- (d) The Pledge

Such Security shall be granted in favour of the Security Trustee for the benefit of the Bondholders. The Issuer has entered into a Security Trust Agreement with the Security Trustee and the Guarantor for the benefit of such Bondholders to represent their interests and effect payment of the principal amount of the Bond and interest in such an event that the issuer fails to satisfy his obligations under the Company's Admission Document. The Security Trust shall have at its disposal the Collateral for the benefit of the Bondholders.

The Security Trustee's role includes

- (i) Acts as a Pledgee and thus receives all funds from the Bond issue and holds onto them until the Centris II property is transferred from PTL and KAH and until the above-mentioned Special hypothec, General hypothec and Guarantee are granted in favour of the security trust and

- (ii) Holding of the Collateral for the benefit of the Bondholders and the enforcement of the said Collateral upon the occurrence of certain events. The Security Trustee shall have no payment obligations to Bondholders under the Bonds which remain exclusively the obligations of the Company, or, in the case of default by the Issuer, of the Guarantor.

The Security Trust shall be created in terms of article 2095E of the Civil Code (Chapter 16 of the Laws of Malta). This security shall exist in the name of the Security Trustee for the benefit of the Bondholders for all the amounts due to the Bondholders and thus the principal amount and any interest due on the Bond, in terms of the Company Admission Document of the Company.

The Security Trustee may, at its sole discretion, require the Company and the Guarantor to enter into any arrangement it deems necessary for the benefit of the Bondholders.

The Guarantor has created a Special Hypothec over the following asset as a security in favour of the Security Trust, for the benefit of the Bondholders, which more than covers the nominal issue of this Secured Callable bond:

- (i) The immovable property located at Centris II, Triq il-Palazz I-Ahmar Mriehel currently valued at €6,700,000. This shall be Secured Callable by a Special Hypothec for the Security Trustee.

The property mentioned in (i) above is also covered by an insurance policy. This policy shall be available for inspection.

In such an event that an Event of Default materialises, the Security Trustee shall have the authority to enforce the relevant Collateral. The Security Trustee shall not make any assumption that any Event of Default has materialised but shall carry out due checks and controls towards ensuring that the Company and the Guarantor are observing the terms of this issue.

Should any of the Events of Default materialise, the Security Trustee shall, in terms of the Security Trust Deed, pay the below dues in such an order;

- a. The Security Trustee for its professional fees in relation to the Security Trust services;
- b. The Bondholders in terms of the Company Admission Document;
- c. The Company and the Guarantor, if any funds remain.

21.25.1 Constitution of the Security

The constitution of the Security pertaining to Centris II in favour of KA Trust will take place as follows:

- (i) The bond proceeds are to be kept by the Security Trustee in a nominee account held with Curmi & Partners;
- (ii) On the agreed transfer day of Centris II from PTL to KAH, which is expected to take place on 12th August 2019, the Security Trustee will issue a direct payment to HSBC (equivalent to €0.9 million) to extinguish the outstanding loan of PTL with HSBC in relation to Centris II;
- (iii) Concurrently with the extinguishment of the loan with HSBC (as per point (ii) above), the special hypothec on Centris II in favour of HSBC will be cancelled;
- (iv) The Security Trustee will issue a direct payment in favour of PTL of €1.1 million (the difference between the transfer price of €2 million to acquire Centris II, as stated in the use of proceeds, and the amount paid to HSBC to extinguish the debt);
- (v) In parallel to (ii), (iii) and (iv) above, the deed of sale for the acquisition of Centris II by KAH is entered into and the Special Hypothec on Centris II in favour of KA Trust is finalised;
- (vi) As soon as the Special Hypothec on Centris II is constituted in favour of the KA Trust, the Security Trustee will transfer the remaining bond proceeds to KA Finance plc.

Further details can be found in Annex B by reviewing the Security Trust Deed and the pledge agreement.

22 Taxation

22.1 General

Investors and prospective investors are urged to seek professional advice as regards both Maltese and any foreign tax legislation which may be applicable to them in respect of the Bonds, including their acquisition, holding and transfer, as well as any income/gains derived therefrom or made on their transfer. The following is a summary of the anticipated tax treatment applicable to the Bonds and to Bondholders in so far as taxation in Malta is concerned at the time of issue of this Company Admission Document. This information does not constitute legal or tax advice and does not purport to be exhaustive.

The information below is based on an interpretation of tax law and practice relative to the applicable legislation, as known to the Issuer at the date of issue of the Company Admission Document, in respect of a subject on which no official guidelines exist. Investors are reminded that tax law and practice and their interpretation, as well as the levels of tax on the subject matter referred to in the preceding paragraph, may change from time to time.

This information is being given solely for the general information of prospective investors. The precise implications for investors will depend, among other things, on their particular circumstances and on the classification of the Bonds from a Maltese tax perspective, and professional advice in this respect should be sought accordingly.

22.2 Malta Tax on Interest

, Unless the Issuer is otherwise instructed by a Bondholder or if the Bondholder does not fall within the definition of "recipient" in terms of article 41(c) of the Income Tax Act (Cap. 123 of the laws of Malta), interest shall be paid to such person net of a final withholding tax, currently at the rate of 15% (10% in the case of certain types of collective investment schemes) of the gross amount of the interest pursuant to article 33 of the said Income Tax Act. Bondholders who do not fall within the definition of a "recipient" do not qualify for the said rate and should seek advice on the taxation of such income.

This withholding tax is considered as a final tax and a Maltese resident individual Bondholder need not declare the interest so received in his income tax return if paid net of tax. No person shall be charged to further tax in respect of such income and the tax deducted shall not be available as a credit against the recipient's tax liability or available as a refund.

In the case of a valid election made by an eligible Bondholder resident in Malta to receive the interest due without the deduction of final tax, interest will be paid gross and such person will be obliged to declare the interest so received in his income tax return and be subject to tax on it at the standard rates applicable to that person at that time. Additionally, in this latter case the Issuer will

advise the Malta Commissioner for Revenue on an annual basis in respect of all interest payments and of the identity of all such recipients. Any such election made by a resident Bondholder at the time of subscription may be subsequently changed by giving notice in writing to the Issuer. Such election or revocation will be effective within the time limit set out in the Income Tax Act (Cap. 123 of the laws of Malta).

In terms of article 12(1)(c) of the Income Tax Act (Cap. 123 of the laws of Malta), Bondholders who are not resident in Malta and satisfying the applicable conditions set out in the Income Tax Act (Cap. 123 of the laws of Malta) are not taxable in Malta on the interest received and will receive interest gross, subject to the requisite declaration/evidence being provided to the Issuer in terms of law.

22.3 Exchange of Information

In terms of applicable Maltese legislation, the User and/or its agent are required to collect and forward certain information (including but not limited to, information regarding payments made to certain Bondholders) to the Commissioner of Revenue. The Commissioner for Revenue may, in turn, automatically or on request, exchange the information to other relevant tax authorities subject to certain conditions. Please note that this does not constitute tax advice and Applicants are to consult their own independent tax advisers in case of doubt.

22.4 Foreign Account Tax Compliance Act

The United States (US) enacted the Foreign Account Tax Compliance Act, 2010 (FATCA) that generally imposes a reporting regime and withholding requirements with respect to certain US source payments (including dividends and interest), gross proceeds from the disposition of property that can produce US source interest and dividends and certain payments made by, and financial accounts held with, entities that are classified as financial institutions under FATCA. The US entered into an intergovernmental agreement with Malta on 6 December 2013 regarding the implementation of FATCA. More specifically FATCA requires foreign financial institutions to provide the IRS with information on Specified US persons as defined holding accounts outside of the US, including certain non-US entities with US Controlling Persons. Non-compliance shall result in punitive withholding 30% tax on distributions captured by FATCA. Bondholders should choose any custodians or intermediaries with care (to ensure each is compliant with FATCA or other laws or agreements related to FATCA) and provide each custodian or intermediary with any information, forms, other documentation or consents that may be necessary for such custodian or intermediary to ensure compliance with FATCA. The Issuer's obligations under the Bonds are discharged once it has affected payment as stipulated in this Company Admission Document and therefore the Issuer has no responsibility for any amount thereafter transmitted through the payment chain. FATCA requires reporting financial institutions, as defined, to satisfy applicable due diligence and reporting requirements in terms of the intergovernmental agreement entered into by Malta together with the relevant regulations and guidelines issued by the Commissioner

for Revenue. Consequently, certain confidential information in relation to the Bondholders and/or other relevant persons may be reported to the Commissioner for Revenue and automatically exchanged with the IRS pursuant to these requirements. FATCA is rather complex and each Bondholder should consult his own tax advisor to obtain a more detailed explanation of FATCA and to determine how it might affect such holder in his specific circumstance.

22.5 Maltese Taxation on Capital Gains on Transfer of the Bonds

On the assumption that the Bonds would not fall within the definition of “securities” in terms of article 5(1)(b) of the Income Tax Act (Cap. 123 of the laws of Malta), that is, “shares and stocks and such like instrument that participate in any way in the profits of the company and whose return is not limited to a fixed rate of return”, and that such Bonds are held as a capital asset and not for trading purposes, no Maltese income tax on capital gains should be chargeable in respect of any capital gain arising on the transfer of the Bonds.

22.6 Duty on Documents and Transfers

In terms of the Duty on Documents and Transfers Act (Cap. 364 of the laws of Malta), duty is chargeable *inter alia* on the transfer or transmission *causa mortis* of marketable securities, defined in the said legislation as “*a holding of share capital in any company and any document representing the same*”. Accordingly, the Bonds should not be treated as constituting marketable securities within the meaning of the legislation and that, therefore, the transfer or transmission thereof should not be chargeable to duty.

INVESTORS AND PROSPECTIVE INVESTORS ARE URGED TO SEEK PROFESSIONAL ADVICE AS REGARDS BOTH MALTESE AND ANY FOREIGN TAX LEGISLATION APPLICABLE TO THE ACQUISITION, HOLDING AND TRANSFER OF BONDS AS WELL AS INTEREST PAYMENTS MADE BY THE ISSUER. THE ABOVE IS A SUMMARY OF THE ANTICIPATED TAX TREATMENT APPLICABLE TO THE BONDS AND TO BONDHOLDERS. THIS INFORMATION, WHICH DOES NOT CONSTITUTE LEGAL OR TAX ADVICE, REFERS ONLY TO BONDHOLDERS WHO DO NOT DEAL IN SECURITIES IN THE COURSE OF THEIR NORMAL TRADING ACTIVITY.

23 Terms and Conditions of The Bond Issue

The following terms and conditions shall be read in conjunction with all the other terms and conditions relative to and regulating the contractual relationship created between the Issuer and the Guarantor on the one hand and the Security Trustee and Bondholders on the other.

- 23.1 The issue and allotment of the Secured Callable Bonds is conditional upon: (i) the Collateral being constituted in favour of the Security Trustee, in accordance with the provisions of the Pledge Agreement and the Security Trust Deed prior to Admission; and (ii) the Bonds being admitted to the Prospects MTF List of the MSE. In the event that either of the aforementioned conditions is not satisfied within 15 Business Days of the close of the Issue Period, any application monies received by the Issuer will be returned without interest by direct credit into the Applicant's bank account indicated by the Applicant on the relative Application Form. If no such bank account number is provided, or in the event that bank account details on the Application Form are incorrect or inaccurate, such returns will be made by means of a cheque mailed to the Applicant's address (or, in the case of joint applications, the address of the first named Applicant) indicated in the Application Form. The Issuer shall not be responsible for any charges, and any loss or delay in transmission.
- 23.2 The completed Application Forms are to be lodged with the Placement Agent and Manager.
- 23.3 It is the responsibility of investors wishing to apply for the Secured Callable Bonds to inform themselves as to the legal requirements of so applying, including any requirements relating to external transaction requirements in Malta and any exchange control in the countries of their nationality, residence or domicile.
- 23.4 The contract created by the Issuer's acceptance of an Application filed by a prospective bondholder shall be subject to all the terms and conditions set out in this Company Admission Document and the Memorandum and Articles of Association of the Issuer.

- 23.5 Any person, whether natural or legal, shall be eligible to submit an Application and any one (1) person, whether directly or indirectly, should not submit more than one (1) application form. If an Application Form is signed on behalf of another party or on behalf of a corporation or corporate entity or association of persons, the person signing will be deemed to have duly bound his principal, or the relative corporation, corporate entity, or association of persons, and will be deemed also to have given the confirmations, warranties and undertakings contained in these terms and conditions on their behalf. Such representative shall be requested to submit the relative power of attorney/resolution or a copy thereof duly certified by a lawyer or notary public unless already known to the Placement Agent / Manager..
- 23.6 In the case of joint Applications, reference to the Applicant in these Terms and Conditions is a reference to each of the joint Applicants, and liability therefor is joint and several.
- 23.7 Applications in the name and for the benefit of minors shall be allowed provided that they are signed by both parents or the legal guardian/s and accompanied by a Public Registry birth certificate of the minor in whose name and for whose benefit the Application Form is submitted. Any Secured Callable Bonds allocated pursuant to such an Application Form shall be registered in the name of the minor as Bondholder, with interest and redemption monies payable to the parents / legal guardian/s signing the application form until such time as the minor attains the age of eighteen (18) years, following which all interest and redemption monies shall be paid directly to the registered holder, provided that the Issuer has been duly notified in writing of the fact that the minor has attained the age of eighteen (18) years.
- 23.8 The Secured Callable Bonds have not been and will not be registered under the Securities Act of 1933 of the United States of America and, accordingly, may not be offered or sold within the United States or to or for the account or benefit of a U.S. person (as such term is defined in Regulation S under the Securities Act of 1933 of the United States of America, as amended).
- 23.9 No person receiving a copy of the Company Admission Document or an Application Form in any territory other than Malta may treat the same as constituting an invitation or offer to such person nor should such person in any event use such Application Form, unless, in the relevant territory, such an invitation or offer could lawfully be made to such person or such Application Form could lawfully be used without contravention of any registration or other legal requirements.
- 23.10 It is the responsibility of any person outside Malta, wishing to make any Application, to satisfy himself/herself/itself as to full observance of the laws of any relevant territory in connection therewith, including obtaining any requisite governmental or other consent, observing any other formality required to be observed in such territory and paying any issue, transfer or other taxes required to be paid in such territory.

- 23.11 Subject to all other terms and conditions set out in the Company Admission Document, the Issuer reserves the right to reject, in whole or in part, or to scale down, any Application, including multiple or suspected multiple applications, and to present any cheques and/or drafts for payment upon receipt. The right is also reserved to refuse any Application which in the opinion of the Issuer is not properly completed in all respects in accordance with the instructions, and/or this Company Admission Document, and/or is not accompanied by the required documents. Only original Application Forms will be accepted and photocopies/facsimile copies will not be accepted. In the case of joint Applications, reference to the Applicant in these Terms and Conditions is a reference to each Applicant, and liability therefor is joint and several.
- 23.12 Save where the context requires otherwise or where otherwise defined therein, terms defined in the Company Admission Document bear the same meaning when used in these Terms and Conditions, in the Application Forms, in any of the annexes and in any other document issued pursuant to the Company Admission Document.
- 23.13 The Issuer has not sought assessment of the Secured Callable Bonds by any independent credit rating agency.
- 23.14 The Secured Callable Bonds will be issued in multiples of €100. The minimum amount of Secured Callable Bonds that can be subscribed for by each Applicant is €2,000.
- 23.15 Subject to all other Terms and Conditions set out in the Company Admission Document, the Issuer reserves the right to revoke the issue at any time before the closing of the Issue Period. The circumstances in which such revocation might occur are expected to be exceptional, for example where a significant change in market conditions occurs.
- 23.16 For the purposes of the PMLFT Regulations, all appointed authorised financial intermediaries are under a duty to communicate to the CSD, all information including customer due diligence data about clients as is required under the Implementing Procedures issued by the Financial Intelligence and Analysis Unit in view of its placing of reliance on the said intermediaries under the said Regulations and Articles 1.2(d) and 2.4 of the "Members' Code of Conduct" appended as Appendix 3.6 to Chapter 3 of the Malta Stock Exchange Bye-Laws, irrespective of whether the said appointed authorised financial intermediaries are Malta Stock Exchange members or not. Such information shall be held, recorded and controlled by the Malta Stock Exchange in terms of the said PMLFT Regulations, GDPR and the Data Protection Act (Chapter 586 of the laws of Malta) for the purposes and within the terms of the Malta Stock Exchange Data Protection Policy as published from time to time.

23.17 Authorised Financial Intermediaries shall, prior to accepting an Application, conduct an Appropriateness Test in respect of the Applicant and, based on the results of such test, be satisfied that an investment in the Bonds may be considered appropriate for the Applicant. To the extent that an Authorised Financial Intermediary is providing advice in respect of a purchase of the Bonds by an Applicant, such Authorised Financial Intermediary shall also be required to conduct a Suitability Test in respect of the Applicant and, based on the results of such test, be satisfied that an investment in the Bonds may be considered suitable for the Applicant. For the purpose of this Securities Note, the term "Appropriateness Test" means the test conducted by any licensed financial intermediary, when providing an investment service (other than investment advice or portfolio management) in relation to the subscription for and the trading of Bonds, for the purpose of such licensed financial intermediary determining (after collecting the necessary information) whether the investment service or the Bonds are appropriate for the prospective Applicant or prospective transferee. In carrying out this assessment, the licensed financial intermediary shall ask the Applicant or the prospective transferee to provide information regarding the Applicant or transferee's knowledge and experience so as to determine that the Applicant or transferee has the necessary experience and knowledge in order to understand the risks involved in relation to the Bonds or investment service offered or demanded, in accordance with Part BI of the Investment Services Rules for Investment Service Providers as promulgated by the Malta Financial Services Authority (the "ISR") In the event that the licensed financial intermediary considers, on the basis of the test conducted, that the transfer of Bonds is not appropriate for the Applicant or prospective transferee, the licensed financial intermediary shall reject the prospective Applicant's request to subscribe for or acquire Bonds, irrespective of whether the Applicant or transferee is warned that the investment in the Bonds is not appropriate for the Applicant or transferee.

For the purpose of this Securities Note, the term "Suitability Test" means the process through which a licensed financial intermediary providing investment advice or portfolio management services in relation to the subscription for and trading of Bonds obtains such information from the Applicant or prospective transferee as is necessary to enable the licensed financial intermediary to recommend to or, in the case of portfolio management, to effect for, the Applicant or prospective transferee, the investment service and trading in Bonds that are considered suitable for him/her, in accordance with Part BI of the ISR. The information obtained pursuant to this test must be such as to enable the licensed financial intermediary to understand the essential facts about the Applicant or prospective transferee and to have a reasonable basis for believing, giving due consideration to the nature and extent of the service provided, that the specific transaction to be recommended, or to be entered into in the course of providing a portfolio management service, satisfies the following criteria:

- a) it meets the investment objectives of the Applicant or prospective transferee in question;
- b) it is such that the Applicant or prospective transferee is able financially to bear any related investment risks consistent with investment objectives of such Applicant or prospective transferee; and

- c) it is such that the Applicant or prospective transferee has the necessary experience and knowledge in order to understand the risks involved in the transaction or in the management of his portfolio.

Any licensed financial intermediary effecting a transfer of Bonds in the secondary market shall be required to carry out an Appropriateness Test and, if providing advice, a Suitability Test, in respect of the transferee, and be satisfied, based on the results of such test (or tests, as applicable), that an investment in the Bonds may be considered appropriate and/or suitable (as applicable) for such transferee

23.18 By completing and delivering an Application Form, the Applicant:

- I. agrees and acknowledges to have had the opportunity to read the Company Admission Document and to be deemed to have had notice of all information and representations concerning the Issuer and the Guarantor and the issue of the Secured Callable Bonds contained therein;
warrants that the information submitted by the Applicant in the Application Form is true and correct in all respects and in the case where an MSE account number is indicated in the Application Form, such MSE account number is the correct account of the Applicant.
- II. Authorises the Placement Agent and Manager and the Directors of the Issuer to include his/her/its name or, in the case of joint Applications the first named Applicant, in the register of debentures of the Issuer in respect of the Secured Callable Bonds allocated to such Applicant and further authorises the Issuer and the MSE to process the personal data that the Applicant provides in the Application Form, for all purposes necessary and subsequent to the Bond Issue applied for, in accordance with the GDPR and Data Protection Act (Cap. 586 of the laws of Malta). The Applicant has the right to request access to and rectification of the personal data relating to him/her/it as processed by the Issuer and/or the MSE. Any such requests must be made in writing and sent to CSD. The requests must further be signed by the Applicant to whom the personal data relates;
confirms that in making such Application no reliance was placed on any information or representation in relation to the Issuer, the Guarantor or the issue of the Secured Callable Bonds other than what is contained in the Company Admission Document and, accordingly, agree/s that no person responsible solely or jointly for the Company Admission Document or any part thereof will have any liability for any such other information or representation;
- III. agrees that the registration advice and other documents and any monies returnable to the Applicant may be retained pending clearance of his/her/its remittance and any verification

of identity as required by the PLMFT Regulation and regulations made thereunder, and that such monies will not bear interest;

- IV. agrees to provide the Placement Agent and Manager and/or the Issuer, as the case may be, with any information which it/they may request in connection with the Application;
- V. warrants, in connection with the Application, to have observed all applicable laws, obtained any requisite governmental or other consents, complied with all requisite formalities and paid any issue, transfer or other taxes due in connection with his/her/its Application in any territory, and that the Applicant has not taken any action which will or may result in the Issuer or the Placement Agent and Manager acting in breach of the regulatory or legal requirements of any territory in connection with the issue of the Secured Callable Bonds or his/her/its Application;
- VI. warrants that all applicable exchange control or other such regulations (including those relating to external transactions) have been duly and fully complied with;
- VII. represents that the Applicant is not a U.S. person (as such term is defined in Regulation S under the Securities Act of 1933 of the United States of America, as amended) and that he/she/it is not accepting the invitation set out in the Company Admission Document from within the United States of America, its territories or its possessions, or any area subject to its jurisdiction (the "United States") or on behalf or for the account of anyone within the United States or anyone who is a U.S. person;
- VIII. agrees that all documents in connection with the issue of the Secured Callable Bonds and any returned monies, including refunds of all unapplied Application monies, will be sent at the Applicant's own risk and may be sent, in the case of documents, by post at the address (or, in the case of joint Applications, the address of the first named Applicant) as set out in the Application Form and in the case of monies by direct credit, into the Applicant's bank account as indicated by the Applicant on the Application Form;
- IX. renounces to any rights the Applicant may have to set off any amounts the Applicant may at any time owe the Issuer against any amount due under the terms of these Secured Callable Bonds;
- X. irrevocably offers to purchase the number of Secured Callable Bonds specified in his/her/its Application Form (or any smaller number for which the Application is accepted by the Issuer) at the Bond Issue Price subject to the Company Admission Document, the terms and conditions thereof, and the Memorandum and Articles of Association of the Issuer;

- XI. warrants that his/her/its remittance will be honoured on first presentation and agrees that if such remittance is not so honoured he/she/it will not be entitled to receive a registration advice, or to be registered in the register of debentures or to enjoy or receive any rights in respect of such Secured Callable Bonds unless and until payment in cleared funds for such Secured Callable Bonds is received and accepted by the Issuer and/or the Placement Agent and Manager (which acceptance shall be made in the absolute discretion of the Issuer and/or the Placement Agent and Manager and may be on the basis that the Issuer and/or the Placement Agent and Manager is indemnified against all costs, damages, losses, expenses and liabilities arising out of or in connection with the failure of such remittance to be honoured on first presentation) and that, at any time prior to unconditional acceptance by the Issuer and/or the Placement Agent and Manager of such late payment in respect of such Bonds, the Issuer and/or the Placement Agent and Manager may (without prejudice to other rights) treat the agreement to allocate such Secured Callable Bonds as void and may allocate such Secured Callable Bonds to some other person, in which case the Applicant will not be entitled to any refund or payment in respect of such Secured Callable Bonds (other than return of such late payment);
- XII. agrees that all Applications, acceptances of applications and contracts resulting therefrom will be governed by, and construed in accordance with, Maltese Law and that he/she/it submits to the exclusive jurisdiction of the Maltese Courts and agrees that nothing shall limit the right of the Issuer to bring any action, suit or proceeding arising out of or in connection with any such Applications, acceptances of applications and contracts in any other manner permitted by law in any court of competent jurisdiction;
- XIII. warrants that if he/she signs the Application Form on behalf of another party or on behalf of a corporation or corporate entity or association of persons, he/she has due authority to do so and such person, corporation, corporate entity or association of persons will also be bound accordingly, and will be deemed also to have given the confirmations, warranties and undertakings contained in these Terms and Conditions;
- XIV. warrants that he/she is not under the age of eighteen (18) years or if he/she is lodging an Application in the name and for the benefit of a minor, warrants that he/she is the parent/s or legal guardian/s of the minor;
- XV. confirms that, in the case of a joint Application entered into in joint names, the first named Applicant shall be deemed the holder of the Secured Callable Bonds; and

XVI. agrees that, in all cases, any refund of unallocated Application monies will be sent to the Applicant by direct credit into the Applicant's bank account as indicated by the Applicant on the Application Form. No interest shall be due on refunds. The Issuer shall not be responsible for any changes, loss or delay in transmission. If no such bank account number is provided, or in the event that bank account details on the Application Form are incorrect or inaccurate, such refund will be made by means of a cheque mailed to the Applicant's address (or, in the case of joint Applications, the address of the first named Applicant) indicated in the Application Form.

Annex A- Property Valuations

Att: Mr Kurt Abela

June 17th 2019

KA Holdings Ltd

Project Technik,

Canon Road,

Qormi, QRM 9032

RE: Valuation of a commercial building located at 'Centris 1', Triq il-Palazz l-Aħmar, Mrieħel, Birkirkara

Introduction

I, the undersigned Architect & Civil Engineer, have been instructed by Mr Kurt Abela (ID: 0428881M), in his capacity as managing director of KA Holdings Ltd., to prepare a valuation report of a commercial building located at 'Centris 1', Triq il-Palazz l-Aħmar, Mrieħel, Birkirkara. The valuation report is being prepared in connection with the prospective bond issue, to be issued by KA Finance Plc, for which an application will be made for the bonds to be admitted on Prospects MTF, the market regulated as a multilateral trading facility operated by the Malta Stock Exchange.

Basis of Valuation

This valuation report is being prepared in accordance with Chapter 4 of the Prospects MTF Rules (clause 4.13.00). It must be confirmed at the outset that this valuation report is being prepared independently and in accordance with the Appraisal and Valuation manual of the UK Royal Institute of Chartered Surveyors (RICS). There is no conflict of interest in the advice given in this report apart from the fee associated with the preparation of the same report. The valuation is based on the direct knowledge of the site, the Maltese construction and property markets, the area within which this property is located as well as other information provided to me by KA Holdings and their professional advisers.

For the purpose of this report, the market value is defined as the monetary amount a property is expected to realise when the same property is offered for sale in an open market, for a reasonable period of time, by a willing seller, in order to enable the property to be brought to the attention of potential and willing buyers and when the transaction is not affected by any special circumstance that might affect the buyer, the seller, or the property. The market value is based on the assumption that the buyer and the seller are both acting in their own best interests, have entered into the

transaction without any element of compulsion or duress, and the buyer does not have any special relationship or obligation to the seller. Factors that affect the establishment of a market value for a given property include the condition of the property, the interest held, the nature and conditions prevalent in the market at the date of the valuation, the location, permissible use, size and age.

Site visit and data consulted

The property has been visited on December 12th 2018 in connection with this valuation. For this inspection, I was accompanied by Mr Joseph Caruana Dingli, in his capacity of facilities manager for the same building. In addition to the inspection of the property, the following documentation has also been referred throughout the preparation of this report;

- Site Plan
- Mrieħel Industrial Area Policy Map BKM2 (see copy of policy map in Appendix Nr 1)
- Plans of the Building (kindly refer to Appendix Nr 2)
- Planning Authority Development Permits related to the same building
- Websites of local real estate agencies



Figure 1 –Aerial Photo – Property in question is marked in red

The Property

The property in question is located in Triq il-Palazz l-Aħmar in Mrieħel, in close proximity to the commercial premises of other reputable local businesses such as JCR Ltd and Engel and Volkers Malta. Above is an aerial photo of the area within which this building is located. The property in question is marked in red.

The plot over which this property was built has a square area of circa 1240 square metres with a frontage of circa 28.7 linear metres. It consists of three basement levels, a ground floor level, an intermediate level, a first floor level, a second floor level and a receded floor level. Below is a summary of the usage and relative square areas per floor;

- a. Level -3: 30 open plan parking spaces & 1 store of circa 150.0 square metres
- b. Level -2: 31 open plan parking spaces
- c. Level -1: 23 parking spaces & 3 stores having a combined square area of circa 220.0 square metres
- d. Level 0: circa 975.0 square metres of open plan commercial retail space (class 4B) & and a reception area
- e. Intermediate level: circa 460.0 square metres of open plan office space (class 4A)
- f. First Floor level: circa 277.0 square metres of open plan office space (class 4A) & a combined health and well-being facility of circa 740.0 square metres. This comprises of several facilities such as a gym (class 3c), cosmetic clinic (class 2a), beauty academy (class 2c) and a beauty salon (class 4b)
- g. Second floor level: circa 1100.0 square metres of open plan office space (class 4A)
- h. Third floor level (receded floor level): circa 910 square metres of open plan office space (class 4A)

All of the above mentioned commercial spaces are finished to a relatively high standard and the majority of the facilities are rented out and occupied. It must be stated that construction work on this project started in the year 2013, hence the building is relatively new, and so are the finishes within it.

All floors can be accessed via a staircase and three elevators. A secondary emergency staircase is located towards the back end of the building. The external walls are rendered and painted and the façade is finished to a relatively high standard. A photographic survey as well as typical plans of the property are being annexed to this report for ease of reference.

Tenure

The property in question is freehold.

Planning Considerations

The main works comprising the property in question are covered by Planning Authority Development permit PA 0224/14. This development permit supersedes a previously issued permit PA 02567/12. PA 0224/14 covers all of the development except for the change of use of part of the first floor level from offices to a well-being facility and the introduction of the intermediate level. The well-being facility is covered by PA 0634/16 and the introduction of the intermediate floor level is covered by PA 1433/17. (Permit documents and drawings for PA 0224/14, PA 0634/16 and PA 1433/17 are provided in appendix form at the back of this report).

It is also of relevance to note that PA 0224/14 also covers development on the adjacent plot of land that belongs to Project Technik Ltd, a company owned by the same shareholder of KA Holdings Ltd. No construction works have been carried out as yet in the adjacent plot of land and therefore, this site is being excluded from the scope of this valuation report. A separate valuation report is being prepared for the adjacent plot of land, forming part of the KA Holdings portfolio. Once developed, the adjacent plot of land will comprise a similar facility to Centris 1, and thus, for the purpose of this valuation report, it can be called Centris 2. Centris 2, and the site over which it is to be built are being dealt with in a separate valuation report. This being said, it must be noted that although, for the purpose of valuation, these two properties are being dealt with separately, once the adjacent plot of land is developed, the whole facility (Centris 1 & Centris 2) will be considered as one. As a final remark, it must also be pointed out that at the time of writing of this report, there were no enforcement actions and no material contraventions of statutory requirements in the property in question.

Details of registered mortgages, privileges and other charges

Prospects MTF rule 4.13.04 states that a valuation report is to include details of registered mortgages and privileges as well as other charges. It is understood that mortgages associated with the acquisition of the site over which this property was built and with the development of the same site are in place. Details of these mortgages are being provided by the financial advisors of my client in separate reports. Nonetheless, a tabulated summary is being provided below. Copies of the relevant documentation are being annexed

BOV Hypothecs

Centris I, Plot D, Triq il-Palazz L-Ahmar, Mriehel

| <u>No</u> | <u>Ref</u> | <u>Bank</u> | <u>Debtor</u> | <u>Guarantor</u> | <u>Basis</u> | <u>Type</u> | <u>Amount</u> | <u>Type</u> | <u>Amount</u> |
|-----------|------------|-------------|---------------|------------------|--------------|-------------|------------------|-------------|---------------|
| | | | | | | | Eur | | Eur |
| 1 | 8672/2017 | BOV | KAH | n/a | Loan | SH | 2,500,000 | GH | 2,500,000 |
| 2 | 21688/2017 | BOV | PTBS | KAH | Loan | SH | 27,900 | GH | 27,900 |
| 3 | 21695/2017 | BOV | PTBS | KAH | Overdraft | SH | 250,000 | GH | 250,000 |
| | | | | | | | <u>2,777,900</u> | | |

Valuation

At the time of writing of this report, 92% of all rentable space (both commercial as well as parking facilities) forming part of the property in question was rented out to 8 blue chip tenants operating in different industries mainly within the Banking and financial sector (44%), Medical Aesthetics (17%) and creative marketing (10%). All the contracts entered into by the guarantor are for periods of between 4 and 15 years. However, 77% of the contracts in terms of rental income are for periods of between 10 and 15 years. The contracts also stipulate a 2% yearly increase in rent payable by the tenants. Tenants are also responsible for the general repairs and maintenance on equipment which they have bought and installed within their particular rented space. Furthermore, any maintenance expense incurred by KAH will be recharged to the tenants.

The rental agreements referred to above constitute a yearly rental return of €600,000.00 (Euro six hundred thousand). When this rental value is capitalised at the rate of 5.0% (considered to be an average rate of rental return for similar properties in the Maltese market), the market value of the property in question, in its current state, and as free from any other burden or servitude can be set at €12,000,000.00 (Euro Twelve Million).

As a final remark, it must be stated that valuations are not a prediction of price, nor a guarantee of value, and whilst my valuation is one which I consider both reasonable and defensible, different valuers may properly arrive at different opinions value. Moreover, the value of property is susceptible to changes in economic conditions and it may therefore change over relatively short periods of time.



Perit Ivan Bondin

B.E. & A. (Hons), M.Sc (Edin.), A & C.E.

Warrant Nr. 561

Annex Nr 1 –Mrieħel Industrial Area Policy Map

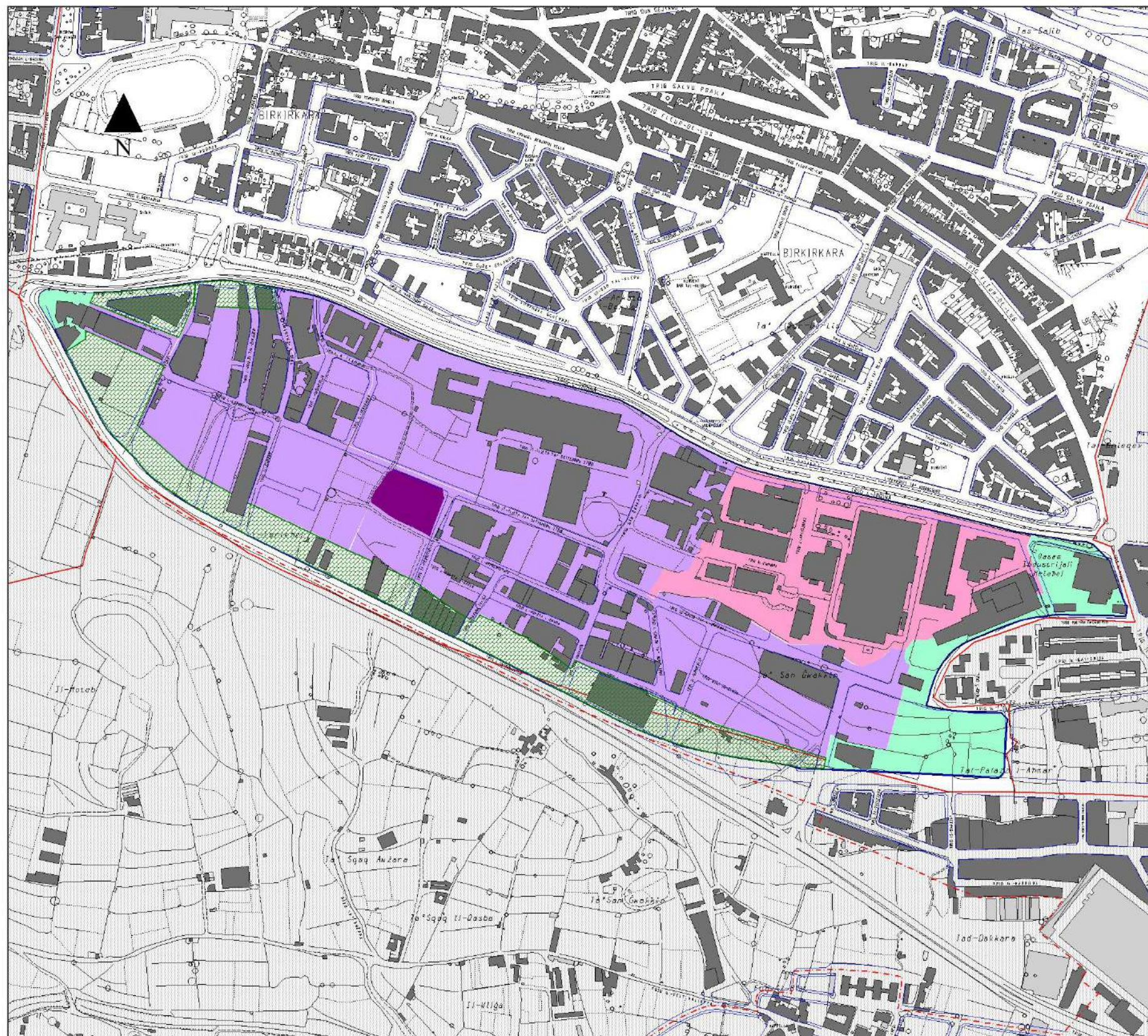

CENTRAL MALTA LOCAL PLAN



L-Awtorita' ta' Malta Dwar l-Ambjent u l-ippjanar
Malta Environment & Planning Authority

Key

- Local Council Boundary
- - - Limit to Development (TPS)
- Mriehel Industrial Area BK04
- MIP Estate
- SME Park
- Commercial Area CG14
- Offices
- Public Utility: Waste Management Civic Amenity Site and Electricity Substation

Mriehel Industrial Area
Area Policy Map

| | | |
|--|------------------|-------------|
| Scale : | Date : | Map : |
| 1:5000 | July 2006 | BKM2 |
| INDICATIVE ONLY Not to be used for direct interpretation or for the interpretation of street alignments. | | |
| Base Maps - 1988 Survey Sheets Copyright Mapping Unit, Malta Environment & Planning Authority | | |

3inset10

Annex Nr 2 – Relevant Permit Documents and Drawings

Site over which centris 2 will be developed. This does not fall within the scope of this valuation report.

SERVICES AREA TO BE CONCEALED BY PARAPET WALL

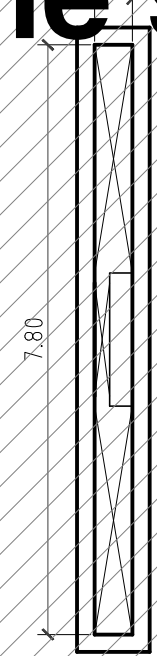
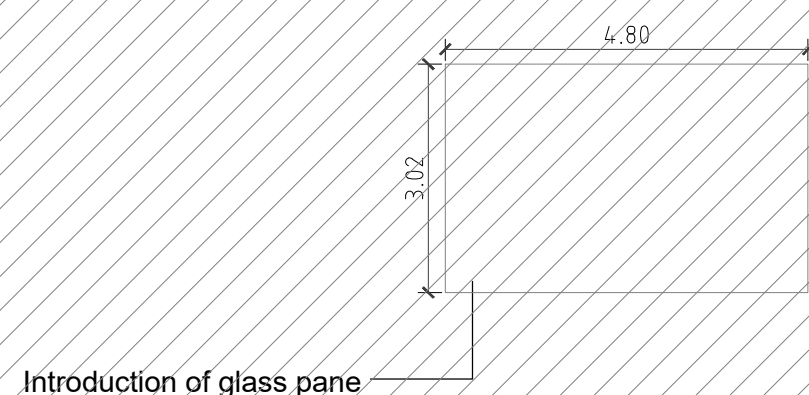

LOW ACCESS HATCH

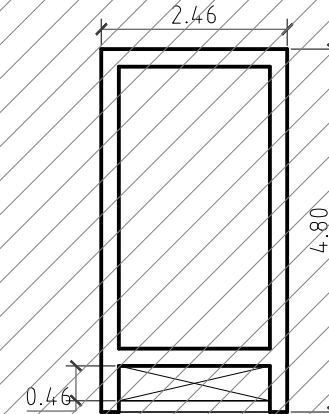
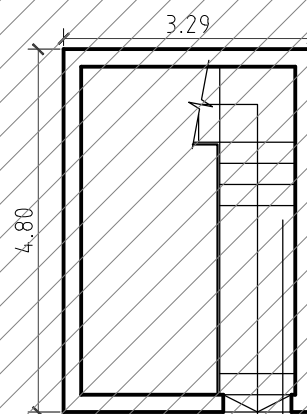

Automatic Open Louvers

ONE COURSE HIGH PERIMETER

Centris 1



LIFTS SHAFT ROOFING

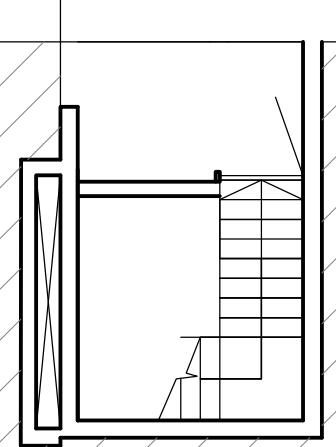

SERVICES AREA

ONE COURSE HIGH PERIMETER

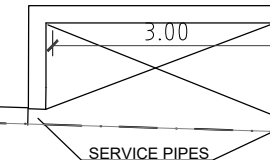

1 PROPOSED ROOF LEVEL



Perit Ivan Bondin

B.E.&A.(Hons.), M.Sc.(Edin.), A.&C.E.

E: info@ibprojects.com.mt

A: Nr.1, Triq Il-Blata l-Kahla, Santa Venera, SVR 1813

A: Nr. 38, Triq ix-Xriek, Mqabba, MQB 1320

T: +356 21498850 / +356 21683147

M: +356 79594078

Project: Amended application to PA/00224/14. Works relate to the introduction of an additional basement parking level, internal and external alterations, change of use for part of ground floor level from commercial class 4B use (retail premises) to class 4A (offices), the construction of three additional full floors and one recessed floor.

Drawing Title: Approved vs Proposed Roof Level

Date: 03/01/2019

Scale: 1:100 A1

Drawing No.: 001_R06

Drawn By: CC

Checked By: IB

Site over which centris 2 will be developed. This does not fall within the scope of this valuation report.

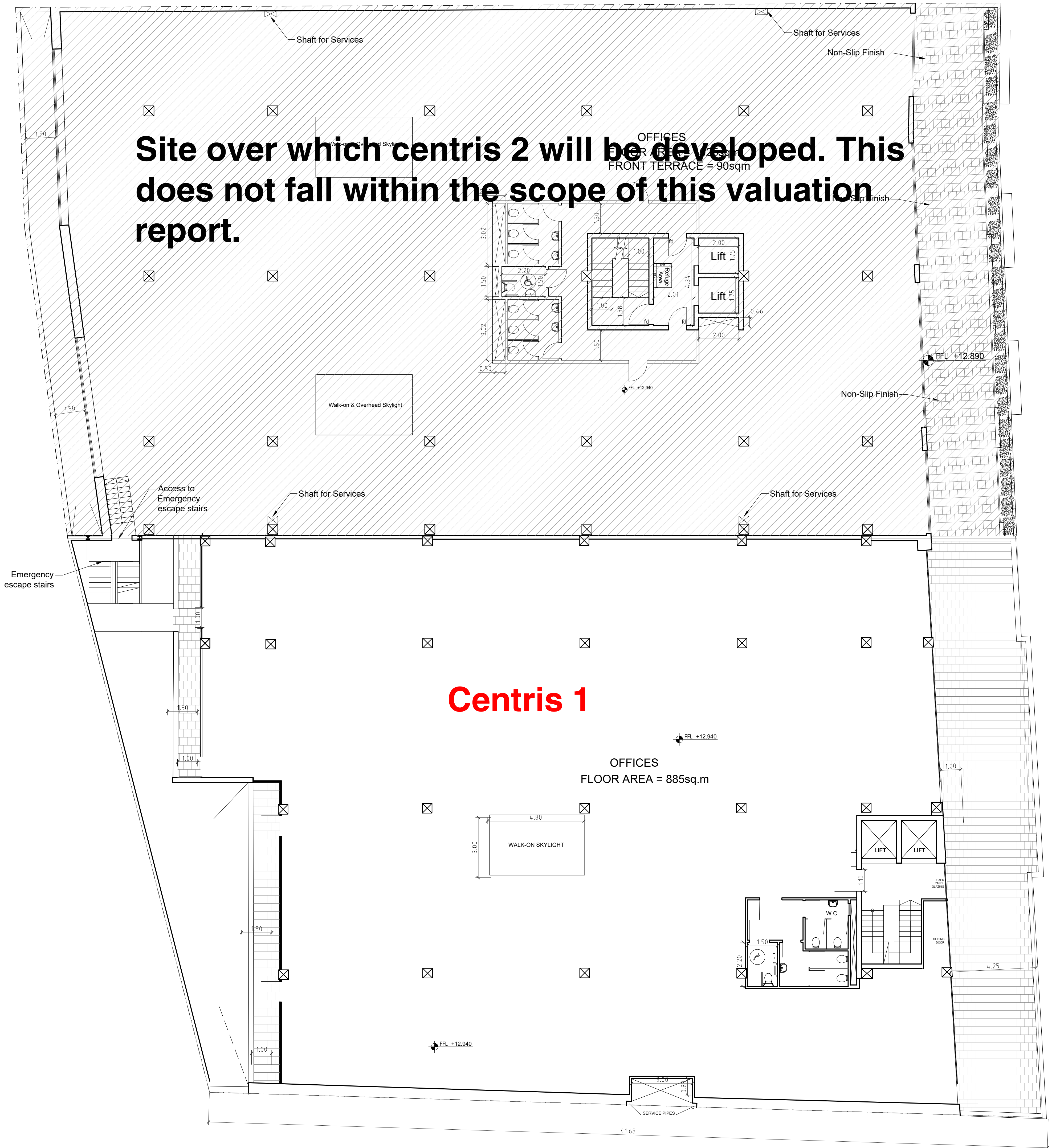

Centris 1

1 PROPOSED THIRD (RECEDED) FLOOR LEVEL

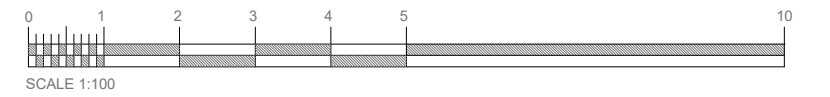

- Drawing Notes:
- All access for all doors shall be min. 900mm wide when open.
 - There shall be no ridges at the joints or anywhere else in the paving surface
 - All external paving materials shall have a non-slip finish

ib projects
Perit Ivan Bondin
 B.E.&A (Hons.), M.Sc.(Edin.), A.&C.E.
 E: info@ibprojects.com.mt
 A: Nr.1, Triq Il-Blata l-Kahla, Santa Venera, SVR 1813
 A: Nr. 38, Triq ix-Xriek, Mqabba, MQB 1320
 T: +356 21498850 / +356 21683147
 M: +356 79594078

Project: Amended application to PA/00224/14. Works relate to the introduction of an additional basement parking level, internal and external alterations, change of use for part of ground floor level from commercial class 4B use (retail premises) to class 4A (offices), the construction of three additional full floors and one receded floor.

Drawing Title: Approved vs Proposed Third (Receded) Floor Level
 Date: 03/01/2019

Scale: 1:100 A1
 Drawing No.: 002_R06
 Drawn By: CC
 Checked By: IB

Site over which centris 2 will be developed. This does not fall within the scope of this valuation report.

OFFICES
FLOOR AREA = 1173sqm

Centris 1

1 PROPOSED SECOND FLOOR LEVEL

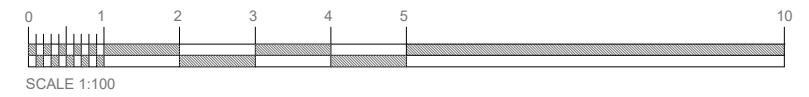

- Drawing Notes:
- All access for all doors shall be min. 900mm wide when open.
 - There shall be no ridges at the joints or anywhere else in the paving surface
 - All external paving materials shall have a non-slip finish

ib projects

Perit Ivan Bondin
B.E.&A.(Hons.), M.Sc.(Edin.), A.&C.E.

E: info@ibprojects.com.mt
A: Nr.1, Triq Il-Blata l-Kahla, Santa Venera, SVR 1813
A: Nr. 38, Triq ix-Xriek, Mqabba, MQB 1320
T: +356 21498850 / +356 21683147
M: +356 79594078

Project: Amended application to PA/00224/14. Works relate to the introduction of an additional basement parking level, internal and external alterations, change of use for part of ground floor level from commercial class 4B use (retail premises) to class 4A (offices), the construction of three additional full floors and one recessed floor.

Drawing Title: Approved vs Proposed Second Floor Level

Date: 03/01/2019

Scale: 1:100 A1

Drawing No.: 003_R06

Drawn By: CC

Checked By: IB

Site over which centris 2 will be developed. This does not fall within the scope of this valuation report.

FLOOR AREA = 1173sqm

Centris 1

OFFICES
FLOOR AREA = 277sq.m

Changes Covered by
PA 00634/16

1 PROPOSED FIRST FLOOR LEVEL

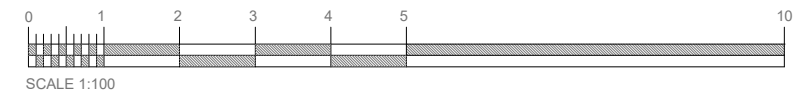

- Drawing Notes:
- All access for all doors shall be min. 900mm wide when open.
 - There shall be no ridges at the joints or anywhere else in the paving surface
 - All external paving materials shall have a non-slip finish

ib projects

Perit Ivan Bondin
B.E.&A (Hons.), M.Sc.(Edin.), A.&C.E.

E: info@ibprojects.com.mt
A: Nr.1, Triq Il-Blata l-Kahla, Santa Venera, SVR 1813
A: Nr. 38, Triq ix-Xriek, Mqabba, MQB 1320
T: +356 21498850 / +356 21683147
M: +356 79594078

Project: Amended application to PA/00224/14. Works relate to the introduction of an additional basement parking level, internal and external alterations, change of use for part of ground floor level from commercial class 4B use (retail premises) to class 4A (offices), the construction of three additional full floors and one recessed floor.

Drawing Title: Approved vs Proposed First Floor Level

Date: 03/01/2019

Scale: 1:100 A1

Drawing No.: 004_R06

Drawn By: CC

Checked By: IB

Site over which centris 2 will be developed. This does not fall within the scope of this valuation report.

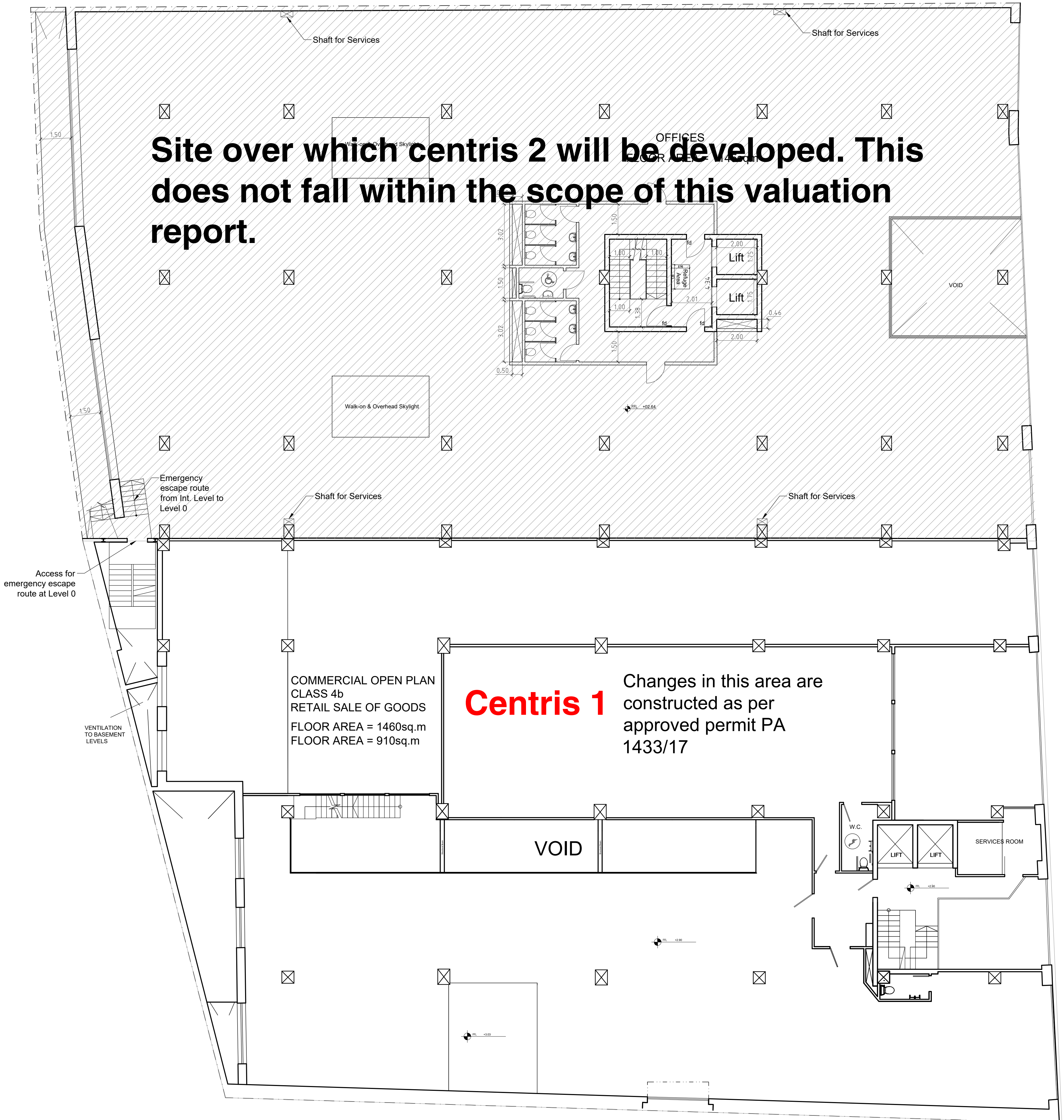

1 PROPOSED INTERMEDIATE LEVEL

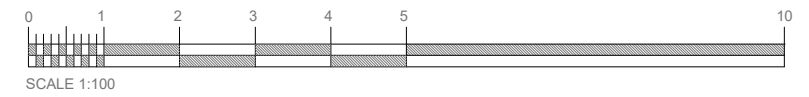

- Drawing Notes:
- All access for all doors shall be min. 900mm wide when open.
 - There shall be no ridges at the joints or anywhere else in the paving surface
 - All external paving materials shall have a non-slip finish

ib projects
Perit Ivan Bondin
 B.E.&A.(Hons.), M.Sc.(Edin.), A.&C.E.
 E: info@ibprojects.com.mt
 A: Nr.1, Triq Il-Blata l-Kahla, Santa Venera, SVR 1813
 A: Nr. 38, Triq ix-Xriek, Mqabba, MQB 1320
 T: +356 21498850 / +356 21683147
 M: +356 79594078

Project: Amended application to PA/00224/14. Works relate to the introduction of an additional basement parking level, internal and external alterations, change of use for part of ground floor level from commercial class 4B use (retail premises) to class 4A (offices), the construction of three additional full floors and one recessed floor.

Drawing Title: Approved vs Proposed Intermediate Level
 Date: 03/01/2019

Scale: 1:100 A1
 Drawing No.: 005_R06
 Drawn By: CC
 Checked By: IB

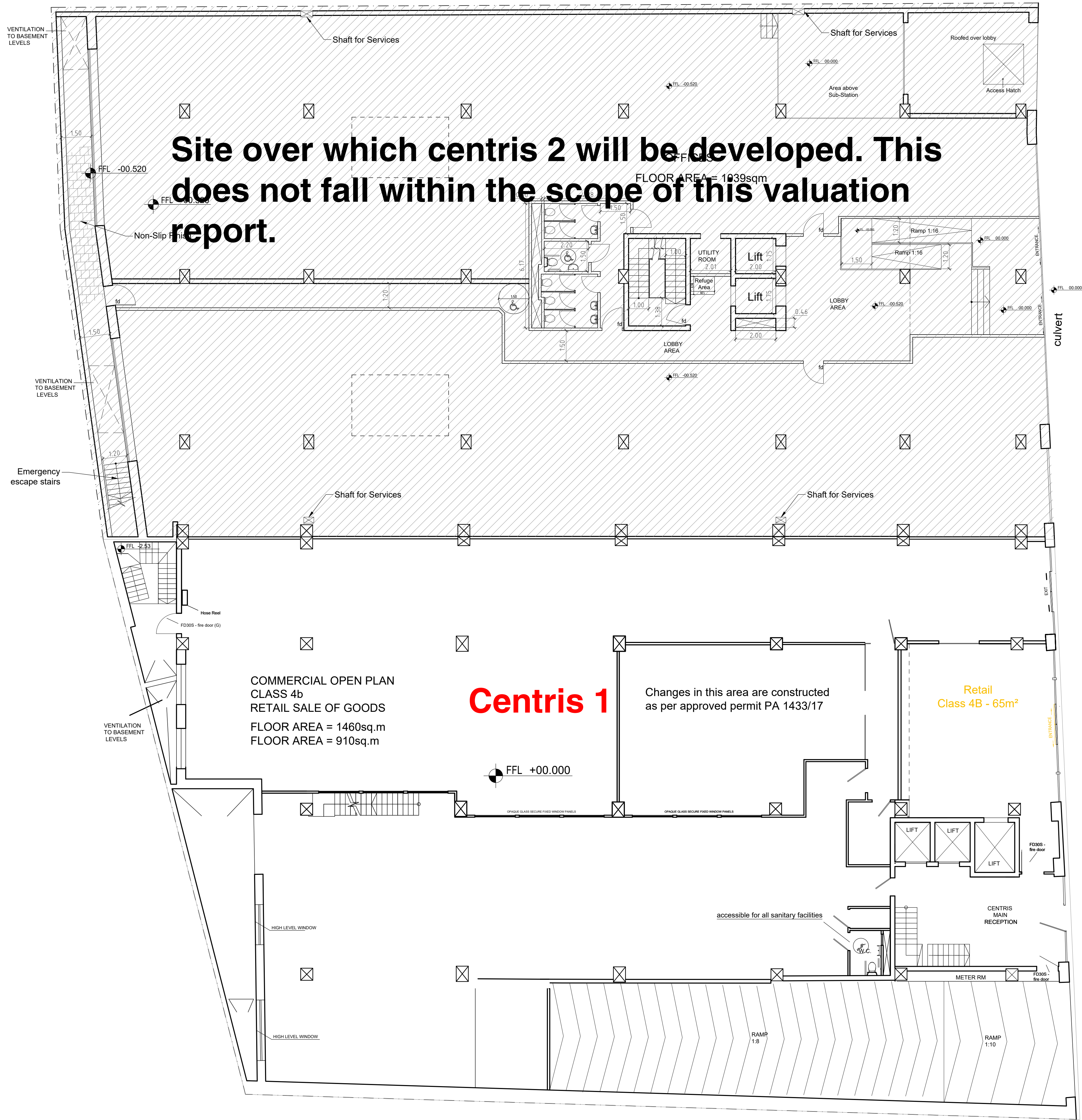

1 PROPOSED LEVEL 0 (GROUND FLOOR)

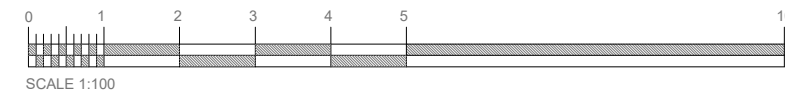

- Drawing Notes:
- All access for all doors shall be min. 900mm wide when open.
 - There shall be no ridges at the joints or anywhere else in the paving surface
 - All external paving materials shall have a non-slip finish

ib projects

Perit Ivan Bondin
 B.E.&A (Hons.), M.Sc.(Edin.), A.&C.E.
 E: info@ibprojects.com.mt
 A: Nr.1, Triq Il-Blata l-Kahla, Santa Venera, SVR 1813
 A: Nr. 38, Triq ix-Xriek, Mqabba, MQB 1320
 T: +356 21498850 / +356 21683147
 M: +356 79594078

Project: Amended application to PA/00224/14. Works relate to the introduction of an additional basement parking level, internal and external alterations, change of use for part of ground floor level from commercial class 4B use (retail premises) to class 4A (offices), the construction of three additional full floors and one recessed floor.

Drawing Title: Approved vs Proposed Level 0 (Ground Floor Level)

Date: 03/01/2019

Scale: 1:100 A1

Drawing No.: 006_R06

Drawn By: CC

Checked By: IB

Site over which centris 2 will be developed. This does not fall within the scope of this valuation report.

Centris 1

1 PROPOSED LEVEL -1

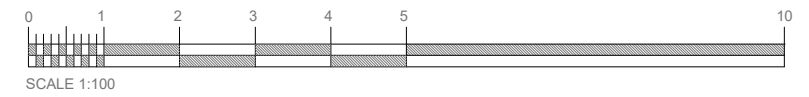

Drawing Notes:
 - All access for all doors shall be min. 900mm wide when open.
 - There shall be no ridges at the joints or anywhere else in the paving surface
 - All external paving materials shall have a non-slip finish

ib projects
 Perit Ivan Bondin
 B.E.&A (Hons.), M.Sc.(Edin.), A.&C.E.
 E: info@ibprojects.com.mt
 A: Nr.1, Triq Il-Blata l-Kahla, Santa Venera, SVR 1813
 A: Nr. 38, Triq ix-Xriek, Mqabba, MQB 1320
 T: +356 21498850 / +356 21683147
 M: +356 79594078

Project: Amended application to PA/00224/14. Works relate to the introduction of an additional basement parking level, internal and external alterations, change of use for part of ground floor level from commercial class 4B use (retail premises) to class 4A (offices), the construction of three additional full floors and one recessed floor.

Drawing Title: Approved vs Proposed Basement Level -1
 Date: 03/01/2019

Scale: 1:100 A1
 Drawing No.: 007_R07
 Drawn By: CC
 Checked By: IB

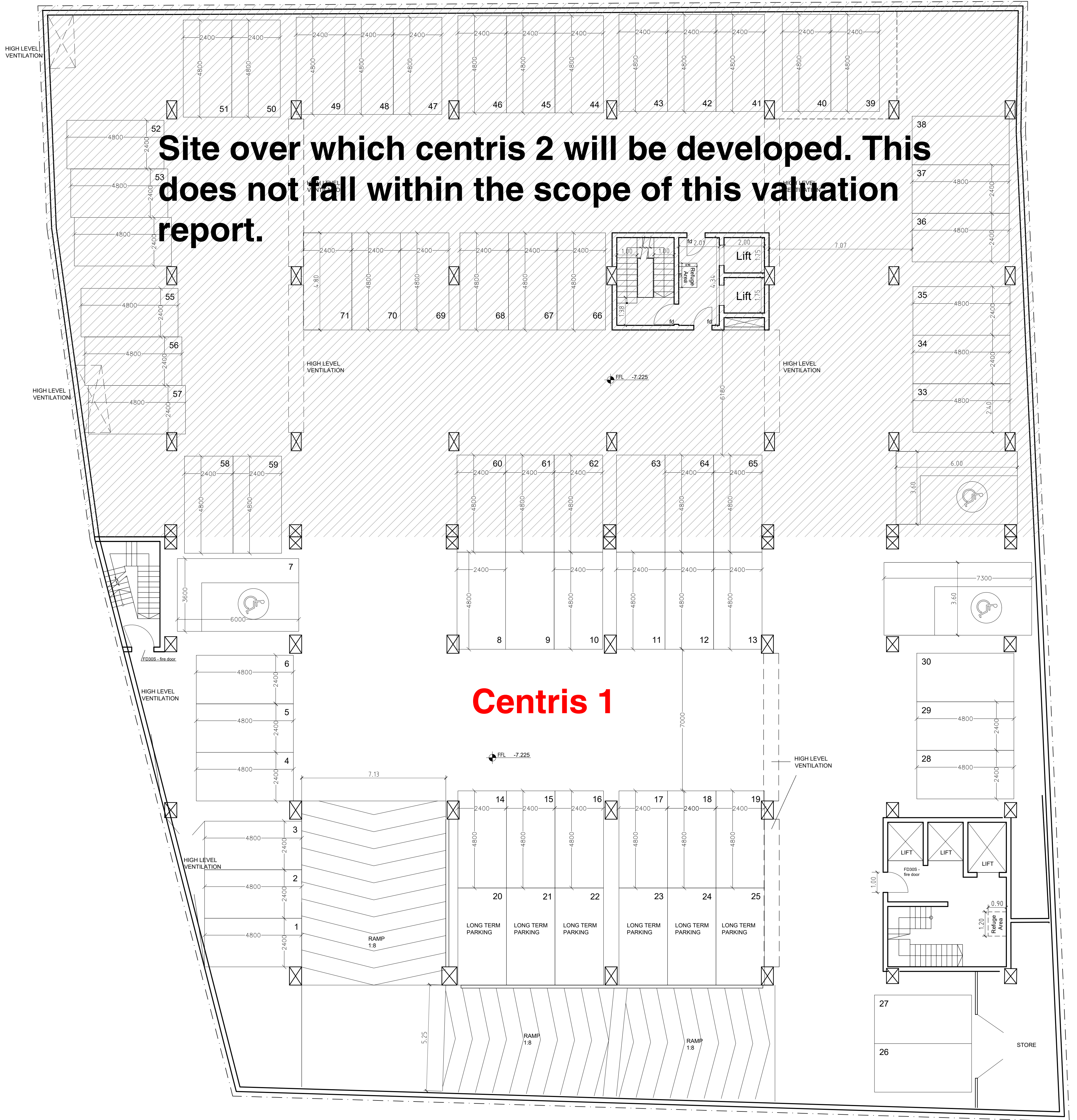

1 PROPOSED LEVEL -2

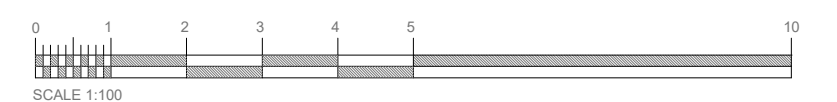

- Drawing Notes:
- All access for all doors shall be min. 900mm wide when open.
 - There shall be no ridges at the joints or anywhere else in the paving surface
 - All external paving materials shall have a non-slip finish



Perit Ivan Bondin
 B.E.&A (Hons.), M.Sc.(Edin.), A.&C.E.
 E: info@ibprojects.com.mt
 A: Nr.1, Triq Il-Blata l-Kahla, Santa Venera, SVR 1813
 A: Nr. 38, Triq ix-Xriek, Mqabba, MQB 1320
 T: +356 21498850 / +356 21683147
 M: +356 79594078

Project: Amended application to PA/00224/14. Works relate to the introduction of an additional basement parking level, internal and external alterations, change of use for part of ground floor level from commercial class 4B use (retail premises) to class 4A (offices), the construction of three additional full floors and one recessed floor.

Drawing Title: Approved vs Proposed Basement Level -2

Date: 03/01/2019

Scale: 1:100 A1

Drawing No.: 008_R07

Drawn By: CC

Checked By: IB

Site over which centris 2 will be developed. This does not fall within the scope of this valuation report.

Centris 1

1 PROPOSED LEVEL -3

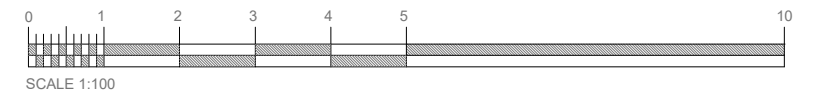

- Drawing Notes:
- All access for all doors shall be min. 900mm wide when open.
 - There shall be no ridges at the joints or anywhere else in the paving surface
 - All external paving materials shall have a non-slip finish

ib projects
Perit Ivan Bondin
 B.E.&A (Hons.), M.Sc.(Edin.), A.&C.E.
 E: info@ibprojects.com.mt
 A: Nr.1, Triq Il-Blata l-Kahla, Santa Venera, SVR 1813
 A: Nr. 38, Triq ix-Xriek, Mqabba, MQB 1320
 T: +356 21498850 / +356 21683147
 M: +356 79594078

Project: Amended application to PA/00224/14. Works relate to the introduction of an additional basement parking level, internal and external alterations, change of use for part of ground floor level from commercial class 4B use (retail premises) to class 4A (offices), the construction of three additional full floors and one recessed floor.

Drawing Title: Approved vs Proposed Basement Level -3
 Date: 03/01/2019

Scale: 1:100 A1
 Drawing No.: 009_R07
 Drawn By: CC
 Checked By: IB

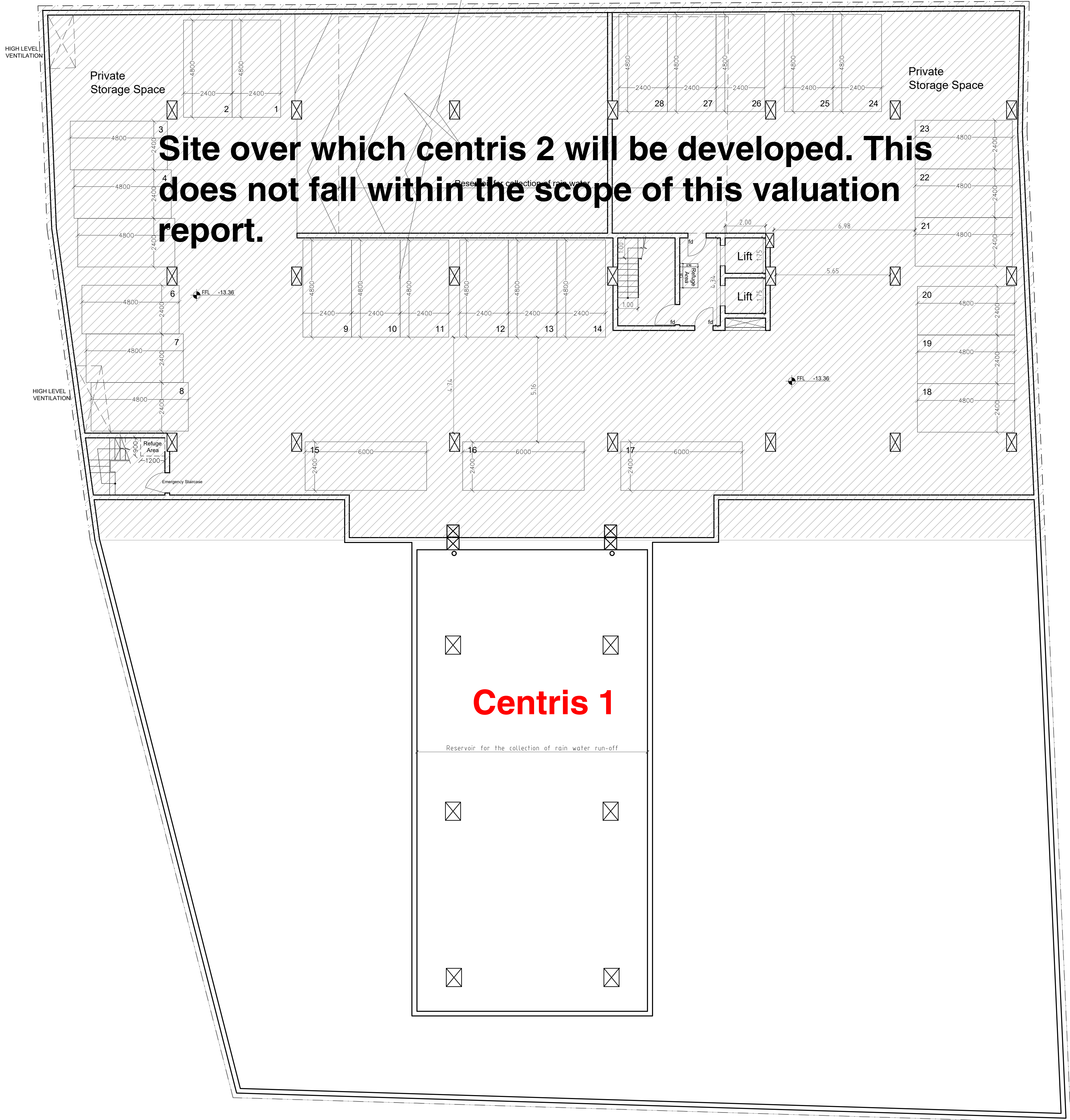

1 PROPOSED LEVEL -4

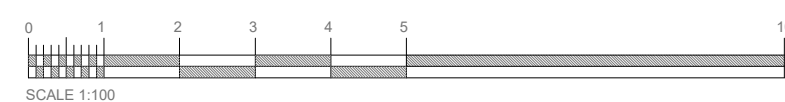

- Drawing Notes:
- All access for all doors shall be min. 900mm wide when open.
 - There shall be no ridges at the joints or anywhere else in the paving surface
 - All external paving materials shall have a non-slip finish



Perit Ivan Bondin
 B.E.&A (Hons.), M.Sc.(Edin.), A.&C.E.
 E: info@ibprojects.com.mt
 A: Nr.1, Triq Il-Blata l-Kahla, Santa Venera, SVR 1813
 A: Nr. 38, Triq ix-Xriek, Mqabba, MQB 1320
 T: +356 21498850 / +356 21683147
 M: +356 79594078

Project: Amended application to PA/00224/14. Works relate to the introduction of an additional basement parking level, internal and external alterations, change of use for part of ground floor level from commercial class 4B use (retail premises) to class 4A (offices), the construction of three additional full floors and one recessed floor.

Drawing Title: Approved vs Proposed Basement Level -4

Date: 03/01/2019

Scale: 1:100 A1

Drawing No.: 014_R07

Drawn By: CC

Checked By: IB



Project: Amended application to PA/00224/14. Works relate to the introduction of an additional basement parking level, internal and external alterations, change of use for part of ground floor level from commercial class 4B use (retail premises) to class 4A (offices), the construction of three additional full floors and one recessed floor.

Drawing: Elevation
Title:

Date: 11/01/2019

Scale: As Noted A1

Drawing No.: 015

Drawn By: CC

Checked By: IB

Copyright © Perit Ivan Bondin. All rights reserved. No part may be reproduced, stored in a retrieval system or transmitted in any form or by any means without the prior written permission of the author.

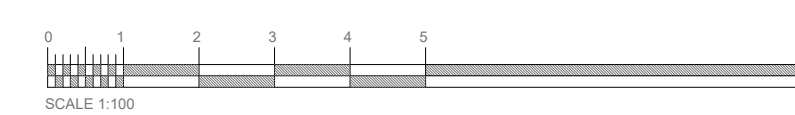

Mr. Kurt Abela
Project Technik
Cannon Road
Qormi QRM 9032

Date: 9 July 2015
Our Ref: PA/00224/14

| | | |
|---------------------|-------------------------------|--|
| Application Number: | PA/00224/14 | |
| Application Type: | Full development permission | |
| Date Received: | 14 June 2013 | |
| Approved Documents: | Site Plan: | PA 224/14/1J |
| | Block plan: | PA 224/14/42O |
| | Basement -3: | PA 224/14/72C |
| | Basement -2: | PA 224/14/72D |
| | Basement -1: | PA 224/14/92B |
| | Ground Floor: | PA 224/14/92C |
| | Intermediate: | PA 224/14/72J |
| | Level 1: | PA 224/14/72G |
| | Level 2: | PA 224/14/72H |
| | Penthouse: | PA 224/14/72I |
| | Roof: | PA 224/14/72K |
| | Section AA: | PA 224/14/72L |
| | Sections BB & CC: | PA 224/14/75C |
| | Section DD: | PA 224/14/72M |
| | Front elevation: | PA 224/14/72B; and supporting documents: |
| | Construction Management Plan: | PA 224/14/19C |
| | Engineer's report: | PA 224/14/104B |
| | Accessibility report: | PA 224/14/77A |

Location: Plot C & D, Triq il-Palazz I-Ahmar, Birkirkara, Malta
Proposal: Building of ground floor premises to include a commercial area Class 4b for retail sale of good with an ancillary area for storage, 3 underlying basement garage levels and an extension to plot D to include a third underlying basement garage level.

Environment and Development Planning Act, 2010 Full Development Permission

The Malta Environment & Planning Authority hereby grants development permission in accordance with the application and documents described above, subject to the following conditions:

- 1 This permission is subject to a Bank Guarantee of €2,166.44 to ensure that the street is properly restored in accordance with the Environmental Management Construction Site Regulations, 2007 (Legal Notice 295 of 2007). The bank guarantee shall only be released

PA/00224/14

Print Date: 09/07/2015

after the perit submits a post-construction condition report together with photographs evidencing compliance with this condition, accompanied by clearance from the Local Council. The clearance from the Local Council is to be endorsed by the Mayor and the Executive Secretary of the Local Council. This guarantee shall be forfeited if, after 3 months from the date of notification by the Authority of a notice to effect the remedial works, these are not carried out. Its forfeiture shall not, however, preclude the applicant from adhering to all the conditions contained in this development permission.

2 The development hereby permitted shall be subject to Final Compliance (Completion) Certification, verifying that the development has been carried out in full accordance with the approved drawings, documents and conditions imposed of permission. Prior to the issuing of the Final Compliance Certificate for this development, the applicant shall submit to MEPA:

(i) clearance from the National Commission for Persons with Disability verifying that the development fully satisfies the accessibility standards and/or any conditions imposed by the Commission in its Accessibility Audit report PA 224/14/77A.

Should a partial compliance certificate be requested, a Bank Guarantee of EUR 50,000 shall be imposed to ensure that the final Compliance (Completion) Certificate is obtained;

(ii) certification from a qualified engineer confirming that the development fully satisfies the requirements specified in report PA 224/14/104B.

3 No industrial activities apart from the required warehousing should be carried out on site. Any activities such as maintenance and servicing of vehicles, manufacturing, spray painting etc. shall require a submission of a new planning application for the required change of use.

4 Permission is hereby being granted for the dismantling of the rubble wall/s as specifically indicated on the approved drawing 42O, in accordance with the terms of Legal Notice 160 of 1997 (and as amended in Legal Notice 169 of 2004), subject to the following conditions:

a) Works are limited to dismantling of the rubble wall(s) as indicated on submitted block plan PA 224/14/ 42O.

b) The works shall not be allowed to result in direct or indirect damage to (or demolition of) any other existing rubble walls other than those covered by this permit, or to any other structure protected by Legal Notice 160 of 1997.

c) All material derived from the dismantling of such walls shall be collected for re-use.

d) Details of the selected entity to whom rubble wall material has been given for re-use, or any other alternative use are to be submitted to EPD for prior approval at least four (4) weeks prior to the initiation of works, and proof of receipt of the stones by the approved entity is to be submitted as verification of compliance with this requirement.

e) The dismantled dry-stone rubble stones should not be used for cladding and facing of any non-rubble walls or structures except where the contrary is explicitly required by EPD.

f) This permit for the dismantling of rubble walls is being issued without prejudice to any additional conditions stipulated in all the relevant development permits.

g) Any soil on the site shall not be built over but shall be collected for re-use in accordance with the Fertile Soil (Preservation) Act, 1973. A permit from the Director of Agriculture may be required to this effect.

h) The deposition and reuse of any soil removed from the site shall be approved in advance by MEPA's Environment Protection Directorate if it would involve deposition or re-use in any site which is located Outside Development Zones or within a scheduled or otherwise legally protected site.

i) All operations concerning the management of waste are subject to the legal provisions of Legal Notice 184 of 2011 [The Waste Management Regulations 2011] as amended by Legal Notice 441 of 2011 and Legal Notice 106 of 2007 [Waste Management (Activity Registration) Regulations of 2007].

Prior to the issue of any compliance certificate on the site, all the above criteria are to be implemented in their entirety to the Environment Protection Directorate's satisfaction. Any failure to comply with the terms of this permission shall be considered as an infringement of the above-mentioned Legal Notices and shall incur the relevant penalties, without prejudice to any additional enforcement action as may also be applicable.

5 Removal and re-use of soil, and management of waste generated by site preparation, excavation and construction operations:

a) Any soil on the site shall not be built over but shall be collected for re-use in accordance with the Fertile Soil (Preservation) Act, 1973. A permit from the Director of Agriculture may be required to this effect.

b) The deposition and reuse of any soil removed from the site shall be approved in advance by MEPA's Environment Protection Directorate if it would involve deposition or re-use in any site which is located Outside Development Zones or within a scheduled or otherwise legally protected site.

c) Contaminated soils are to be managed and disposed of in accordance with the legal provisions laid down in Legal Notice 184 of 2011 [The Waste Management Regulations of 2011] and Legal Notice 168 of 2002 [Waste Management (Landfill) Regulations of 2002] and its amendments.

d) Inert waste material resulting from excavations or from demolition may be reused as fill material on the site covered by this application, or shall be deposited at facilities permitted by MEPA and in accordance with the legal provisions laid down in Legal Notice 184 of 2011 [The Waste Management Regulations of 2011] as amended and Legal Notice 106 of 2007 [Waste Management (Activity Registration) Regulations of 2007].

e) All operations concerning the management of waste are subject to the legal provisions of Legal Notice 184 of 2011 [The Waste Management Regulations 2011] as amended and Legal Notice 106 of 2007 [Waste Management (Activity Registration) Regulations of 2007].

- 6
- a) The approved premises shall be used as indicated on the approved drawings or as limited by any condition of this permission. If a change of use is permitted through the Development Planning (Use Classes) Order, 2014 (or its subsequent amendments), and it is not restricted by a condition of this permission, approval from the National Commission for Persons with Disability may still be required. Reference needs to be made to MEPA Circular 3/10 or its subsequent amendments.
 - b) Where provided, loading and unloading shall take place solely within the premises, and not from/on the public pavement or street.
 - c) Unless shown on the approved drawings, no approval is hereby granted for the display of any sign or advertisement. These must form the subject of a separate application for advertisement consent.
 - d) No activity is to take place outside the premises, unless clearly indicated on the approved drawings, and no crates or other items are to be stored outside. The placing/installation of any structures or facilities in front of the premises, unless indicated on the approved drawings, must be the subject of a separate clearance/permission from MEPA.
- 7
- a) The facades of the building shall be constructed in local unrendered and unpainted stone, except where other materials, finishes and colours are indicated on the approved drawings.
 - b) Any balconies shall be located so that their side outer face is at least 0.75 metres away from the outer face of the party wall nearest to the balconies. The balconies shall not project more than 1.5 metres from the facade of the building where a front garden is present or not more than 1 metre from the façade of the building where no front garden is present. Any closed balconies shall not project more than 0.6 metres from the façade of the building.
 - c) Any projecting rooms shall not project more than 0.75 metres from the facade of the building (where no front garden is present) or not more than 1 metre from the facade of the building (where a front garden is present).
 - d) All external apertures and balconies shall not be in gold, silver or bronze aluminium.
 - e) Where applicable, the 'solid part' of the boundary wall in the front garden shall not be higher than five courses (1.4 metres) above the external finished road level. Where the site is sloping, the wall shall be stepped so that it follows the profile of the building. Any pillars or gateposts shall not exceed a height of 8 courses (2.25 metres).
 - f) Where applicable, the penthouse level shall be set back by at least 4.25 metres from the front facade and by 1.5 metres from the back of the building. The external height of the penthouse shall not exceed 3.4 metres above roof level. No structures (other than those shown on the approved drawings) shall be constructed on the roof of the building. Where permitted on the approved drawings, the canopy at penthouse level shall project by not more than 1 metre, shall be cantilevered, and shall remain open from the sides and the front without any support on party walls and/or pillars.
 - g) All services located on the roof of the building shall be clustered together and surrounded by a 1.5 metres high non-solid screen. The services shall not exceed the height of this screen, which shall be set back 2 metres from the front and back edges of

the roof of the underlying structures.

- 8
- a) This development permission is valid for a period of FIVE YEARS from the date of publication of the decision in the press but will cease to be valid if the development is not completed by the end of this validity period.
 - b) This permission relates only to the development as specifically indicated on the approved drawings. This permission does not sanction any other illegal development that may exist on the site.
 - c) Copies of all approved drawings and documents shall be available for inspection on site by MEPA staff at all reasonable times. All works shall be carried out strictly in accordance with the approved drawings, documents and conditions of this permission. Where a matter is not specified, then the conditions of this permission and of Development Control Policy and Design Guidance shall take precedence and shall modify the drawings and documents accordingly.
 - d) Where applicable, all building works shall be erected in accordance with the official alignment and official/existing finished road levels as set out on site by MEPA's Land Surveyor. The Setting Out Request Notice must be submitted to the Land Survey Unit of MEPA when the setting out of the alignment and levels is required.
 - e) Where an officially schemed street, within the development zone, bordering the site is unopened or unformed, it shall be opened up and brought up to its proper, approved and official formation levels prior to the commencement of any development hereby being permitted.
 - f) Before any part of the development hereby permitted commences, the enclosed green copy of this development permission shall be displayed on the site. This must be mounted on a notice board, suitably protected from the weather and located not more than 2 metres above ground level at a point on the site boundary where it is clearly visible and can be easily read from the street. The copy of the permission must be maintained in a good condition and it shall remain displayed on the site until the works are complete.
 - g) The enclosed Commencement Notice shall be returned to MEPA so that it is received at least five days prior to the commencement of any works hereby permitted.
 - h) Where applicable, the development hereby permitted shall be carried out in accordance with the provisions of the Environmental Management Construction Site Regulations, Legal Notice 295 of 2007 (or subsequent amendments). Any hoarding shall be erected in accordance with Schedule 2 of the same Regulations.
 - i) All new developments shall be provided with a water cistern to store rainwater run-off as required by the Energy Performance of Buildings Regulations (2012) [published through Legal Notice 376 of 2012 and any amendments thereto] and to Technical Guidance Document F [published through Government Notice 1002 of 2006 and any amendments thereto] which are prevailing at the time of construction of the development.
 - j) Where applicable, the ramp leading down to the underlying basement/garages for private car parking shall at no point be steeper than 1:5 from the back edge of the pavement. If there are more than 5 public car parking spaces or garages, the ramp shall not be steeper than 1:8 (or 1:10 if helical). The ramp shall always be so formed that it does not encroach onto the pavement.

k) Where applicable, an area of a depth of 4 metres from the pavement, with a gradient not steeper than 1:10, shall be provided within the site for vehicles to wait at pavement level before entering the street.

l) Where applicable, any garages/parking spaces shall only be used for the parking of private cars and they shall be kept available at all times for this purpose.

m) Where applicable, any approved stores shall be used for domestic storage only and shall be physically and internally linked to the overlying dwellings.

n) The height of the development shall not exceed the permitted number of floors and the height in metres as indicated on the approved drawings.

o) No steps, ramps or street furniture are to be constructed on or encroached onto the public pavement or road.

p) Any doors and windows, the lower edge of which is less than 2m above road level, and any gates shall not open outwards onto a public pavement or road.

q) Where applicable, the garage door opening(s) at ground floor level, overlooking the public street, shall be fitted with a solid aperture within the thickness of the external wall along the building alignment. This aperture shall be of the same colour of the other apertures on the elevation, unless otherwise indicated on the approved drawings. This aperture shall be fitted prior to the issue of any Compliance Certificate (partial or full) on the whole or any part of the development hereby approved. No gates are permitted on this opening.

r) Where present, window grilles (including 'pregnant' windows), sills, planters and other similar elements which are part of or fixed to the facade of buildings, the lower edge of which is less than 2 metres above road level, shall not project more than 0.15 metres from the facade over a public pavement or street.

s) Air conditioning units shall not be located on the facades of the building which are visible from a public space/street.

t) There shall be no service pipes, cables or wires visible on the front elevation or on any other elevations of the building which are visible from the street or public space.

9 The Bank Guarantee imposed in condition 4 of PA 2567/12 for the value of €2282.91 shall be amended to cover also this development permit.

A third party may have the right of appeal against this permission. Any action taken on this permission when such an appeal has been made, or until the time limit for the submission of such an appeal has expired, is undertaken at the risk that this permission may be revoked by the Environment and Planning Review Tribunal or quashed by the Court of Appeal.

Where the approved drawings and/or documents are dimensioned, then the declared dimensions shall prevail over the actual size as depicted on the approved drawings and/or documents.

Developers are advised to check the invert level to the sewer main with the Water Services Corporation as they would have to make their own arrangements where a gravity service connection

is not possible. In these cases, the architect has to indicate the solutions envisaged and to indicate on the plan what needs to be carried out and obtain approval from WSC. Developers are further reminded that connection of storm water into main sewers is not allowed.

If the declaration of ownership, as contained in the application form, is determined as incorrect by a Court of Law, then the said Court of Law can declare this development permission as null and void. This development permission does not remove or replace the need to obtain the consent of the land/building owner to this development before it is carried out. Furthermore, it does not imply that consent will necessarily be forthcoming nor does it bind the land/building owner to agree to this development. Where the land/building is owned or administered by the Government of Malta a specific clearance and agreement must be obtained for this development from the Land and/or Estate Management Departments.

This development permission is granted saving third party rights. This permission does not exonerate the applicant from obtaining any other necessary permission, license, clearance or approval required from any Government department, local council, agency or authority (including MEPA), as required by any law or regulation.

This development permit does not authorise any storage of substances listed in Occupational Health and Safety Authority Act (Cap. 424) - Control of Major Accident Hazards Regulations, 2003, as amended, in quantities that would render this site an establishment within scope of these regulations. The storage and handling of said substances may require a new or amended development permission in line with current policies and regulations.

For any non-residential uses hereby being approved, prior to commencement of any works on site or any eventual permitted change of use, the applicant shall be required to contact the Environment Protection Directorate (within MEPA) to obtain any necessary operational permit or registration. This requirement does not apply to Class 2B, 2C, 4A and 4B uses as listed in the Development Planning (Use Classes) Order 2014, or its subsequent amendments.

This decision is being published on 15 July 2015.

Claudine Faure
Head EPC Secretariat
Environment and Planning Commission

Notes to Applicant and Perit

Right for reconsideration

Where applicable, you have a right to submit a request for reconsideration to the Authority in terms of regulation 10 of Legal Notice 514 of 2010.

Right for appeal

You have a right to submit an appeal, against the decision, to the Environment and Planning Review Tribunal in terms of article 41 and the Second Schedule of the Environment and Development Planning Act, 2010.

Time limits

Requests for reconsideration or appeals must be made within 30 days from the publication of the decision notification in the local press as required by regulation 6(6) of Legal Notice 514 of 2010.

Fees to submit a request for reconsideration or appeal

In either case, there is a fee to be paid which should accompany the request for reconsideration or the appeal. The fees are as follows:

For reconsideration - 3% of the Development Permit Fee paid in respect of the original application, subject to a minimum of €69.88.

For appeal - 5% of the Development Permit Fee paid in respect of the original application, subject to a minimum of €186.35.

Submission of request for reconsideration or appeal

With regards to requests for reconsideration, Form MEPA 6/10 must be used for submission. All fields of the Form must be filled in as appropriate. Requests for reconsideration can only be submitted electronically.

With regards to appeals, as required by the Second Schedule of the Act, the submission must include the detailed grounds for appeal and the requests being made by the appellant. Appeals must be submitted physically at the offices of the Environment and Planning Review Tribunal, St. Francis Ditch, Floriana.

Submission of an appeal — General Services Board

If this application has been refused on sanitary issues, an appeal to the General Services Board may be submitted within one month from publication of Decision Notification on the press.

Perit Edward Sammut
Crown Marina Apts, Flat 3, Block B
Ta' Xbiex Seafront
Ta'xbiex XBX1027

-PADCN-

Perit Ivan Bondin
La` Pieta`, 38
Triq Ix-Xriek
Mqabba MQB 1320

Date: 04 Apr 2016
Our Ref: PA/00224/14
Your Ref: 140-11

Dear Sir/Madam

Application Number: PA/00224/14
Application Type: Request for minor amendments to permission
Location: Plot C & D, Triq il-Palazz I-Ahmar, Birkirkara, Malta

**Minor Amendment to Permission PA/00224/14
in terms of regulation 12 of Legal Notice 514 of 2010**

Reference is made to the request for minor amendments, to the above quoted development permission, submitted on 24 March 2016.

The changes you propose are acceptable as a minor amendment to the development permission. The following drawings/documents are being endorsed:

PA 224/14/MA/151A/151B/151C/151D/151E/151G/151H/151I/151J/151K/151L/151M/155A. Fire, Safety and Ventilation Report 151N (Not attached).

This endorsement relates only to the changes described in your application form and specifically indicated on the drawings/documents. Any other changes from the original permission, which may be shown on the drawings/documents but which are not referred to in your application form, are not endorsed or accepted.

Consequently, this endorsement (including sanitary approval) is **only** for the proposed development as specifically indicated and does not cover any other development or sanctions any illegal development which may exist on site, even if shown on the drawings/documents.

Please note that the conditions and amendments in the original permission remain valid and are therefore applicable to the development as amended, including the condition on the validity period of the permission. The other provisions of regulation 12 of Legal Notice 514 of 2010 also apply.

Yours faithfully,

Malcolm Ferriggi B. Plan.
for Executive Chairperson

cc: Mr. Kurt Abela

To: Mr. Kurt Abela
Project Technik
Cannon Road
Qormi QRM 9032

Date: 19 January 2017
Our Ref: PA/00224/14
Perit Ref: 140-11

Dear Sir/Madam,

Application Number: PA/00224/14
Location: Plot C & D, Triq il-Palazz I-Ahmar, Birkirkara, Malta
Proposal: Building of ground floor premises to include a commercial area Class 4b for retail sale of good with an ancillary area for storage, 3 underlying basement garage levels and an extension to plot D to include a third underlying basement garage level.

**Development Planning Act, 2016
Minor Amendment to Permission PA/00224/14
in terms of regulation 15 of Legal Notice 162 of 2016**

Reference is made to the request for minor amendments, to the above quoted development permission, submitted on 5 December 2016.

The changes you propose are acceptable as a minor amendment to the development permission .
The following drawings/documents are being endorsed:

PA224/14/MA/172A/172B/172C/172D & PA224/14/MA/180A/184A (Accessibility Report and updated FSVR - not sent)

This endorsement relates only to the changes described in your application form and specifically indicated on the drawings/documents. Any other changes from the original permission, which may be shown on the drawings/documents but which are not referred to in your application form, are not endorsed or accepted.

Consequently, this endorsement is **only** for the proposed development as specifically indicated and does not cover any other development or sanctions any illegal development which may exist on site, even if shown on the drawings/documents.

Please note that the conditions and amendments in the original permission remain valid and are therefore applicable to the development as amended, including the condition on the validity period of the permission. The other provisions of regulation 15 of Legal Notice 162 of 2016 also apply.

Yours faithfully,

Jeffrey Vella
for Executive Chairperson

-PAABMADcn-

500m

0m

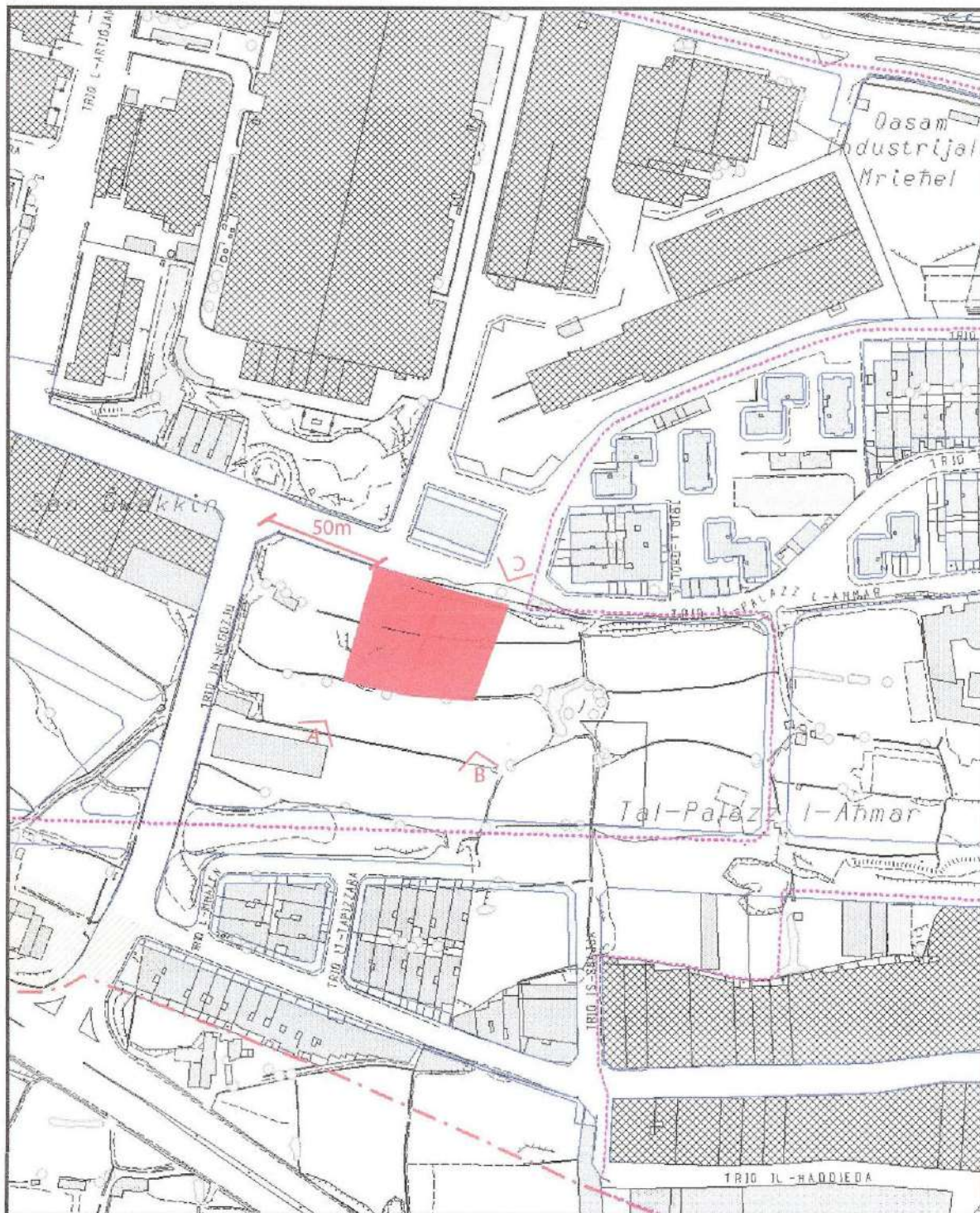

Min Easting = 52036.05, Min Northing = 71588.5, Max Easting = 52436.05, Max Northing = 72088.38

0m

400m

MEPA

www.mepa.org.mt

St. Francis Ravelin
Floriana
PO Box 200, Valletta, Malta
Tel: +356 240976 Fax: +356 224846

Site Plan, Scale 1:2500 Printed on: Thursday, September 22, 2011

Not to be used for interpretation or scaling of scheme alignments

Copyright © Malta. Not for resale.



1 PROPOSED VS APPROVED LEVEL -1
SCALE 1:100

| | | |
|--|---|-------------------------------------|
| Perit Ivan A. Bondin B.E.&A.(Hons.), M.Sc.(Edin.), A.&C.E. La Pietà, 38, Triq ix-Xriek, Mgabba, MQB 1320. Tel: 21683147 Mob: 79594078 Mail: bondin@onvol.net | Job Description: Building of Ground floor premises to include commercial area Class 4b for retail sale of goods with an ancillary area for storage, 3 underlying basement garage levels and an extension to plot D to include a third underlying basement level | Scale: As shown Drawing Nr: A007 |
| | TITLE: Approved vs proposed drawings | Date: 07-03-2016 Drawn by: JB |



1 PROPOSED VS APPROVED LEVEL -2
 SCALE 1:100

| | | |
|--|---|---|
| Perit Ivan A. Bondin B.E.&A.(Hons.), M.Sc.(Edin.), A.&C.E. La Pietà, 38, Triq ix-Xriek, Mgabba, MQB 1320. Tel: 21683147 Mob: 79594078 Mail: bondin@onvol.net | Job Description: Building of Ground floor premises to include commercial area Class 4b for retail sale of goods with an ancillary area for storage, 3 underlying basement garage levels and an extension to plot D to include a third underlying basement level Title: Approved vs proposed drawings | Scale: As shown Drawing Nr: A008 Date: 07-03-2016 Drawn by: IB |
| | Title: Approved vs proposed drawings | |



1 PROPOSED VS APPROVED LEVEL -3
SCALE 1:100

| | | |
|--|---|--|
| Perit Ivan A. Bondin B.E.&A.(Hons.), M.Sc.(Edin.), A.&C.E. La Pietà, 38, Triq ix-Xriek, Mgabba, MQB 1320. Tel: 21683147 Mob: 79594078 Mail: bondin@onvol.net | Job Description: Building of Ground floor premises to include commercial area Class 4b for retail sale of goods with an ancillary area for storage, 3 underlying basement garage levels and an extension to plot D to include a third underlying basement level Title: Approved vs proposed drawings | Scale: As shown |
| | | Drawing Nr: A009 Date: 07-03-2016 Drawn by: IB |

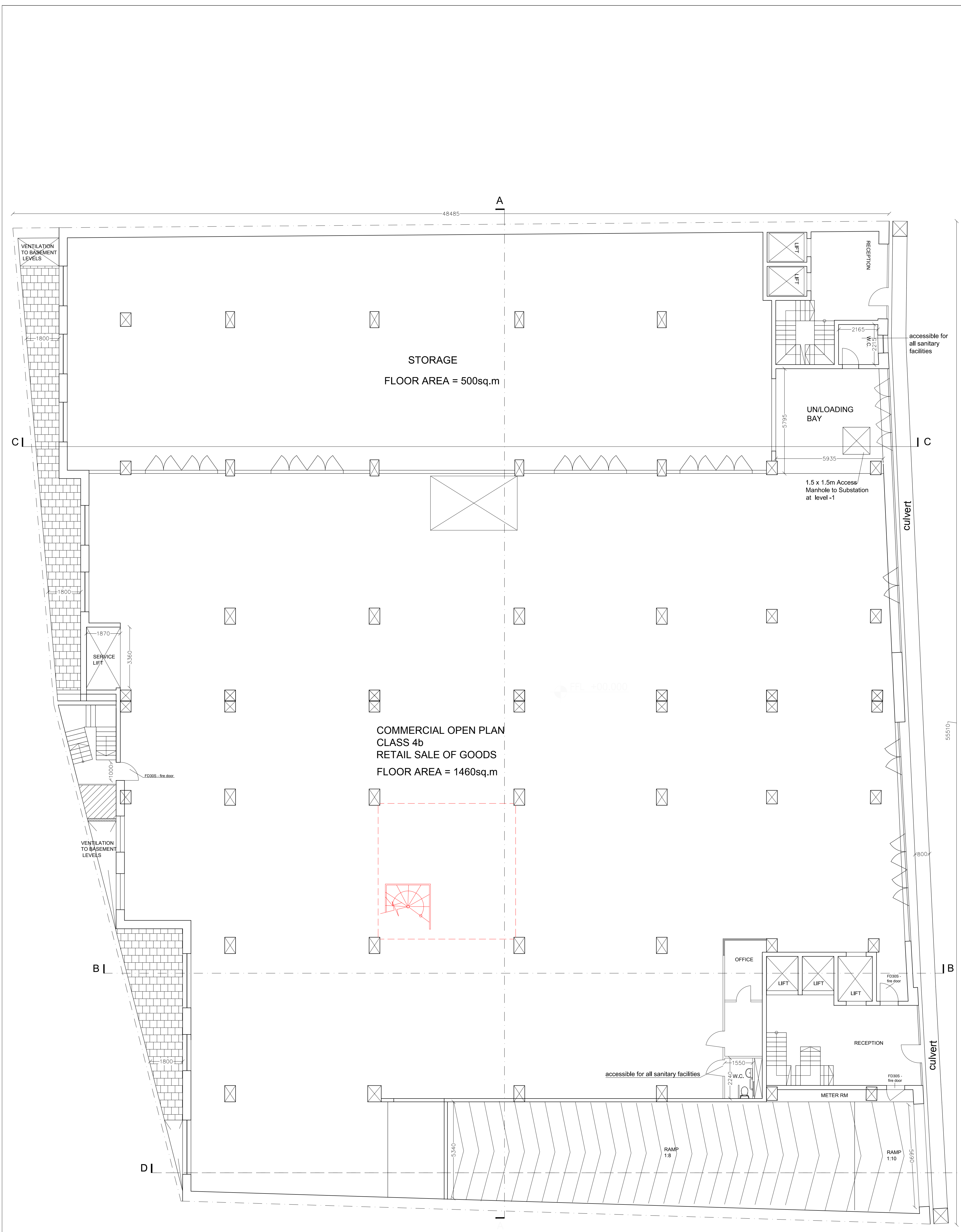

1 PROPOSED VS APPROVED LEVEL 0
SCALE 1:100

| | | |
|---|---|-------------------|
| Perit Ivan A. Bondin B.E.&A.(Hons.), M.Sc.(Edin.), A.&C.E. La Pietà, 38, Triq ix-Xriek, Moqba, MQB 1320. Tel: 21683147 Mob: 79594078 Mail: bondin@onvol.net | Job Description: Building of Ground floor premises to include commercial area Class 4b for retail sale of goods with an ancillary area for storage, 3 underlying basement garage levels and an extension to plot D to include a third underlying basement level | Scale: As shown |
| | Title: Approved vs proposed drawings | Drawing Nr: A005A |
| | Date: 01-12-16 | Drawn by: JB |

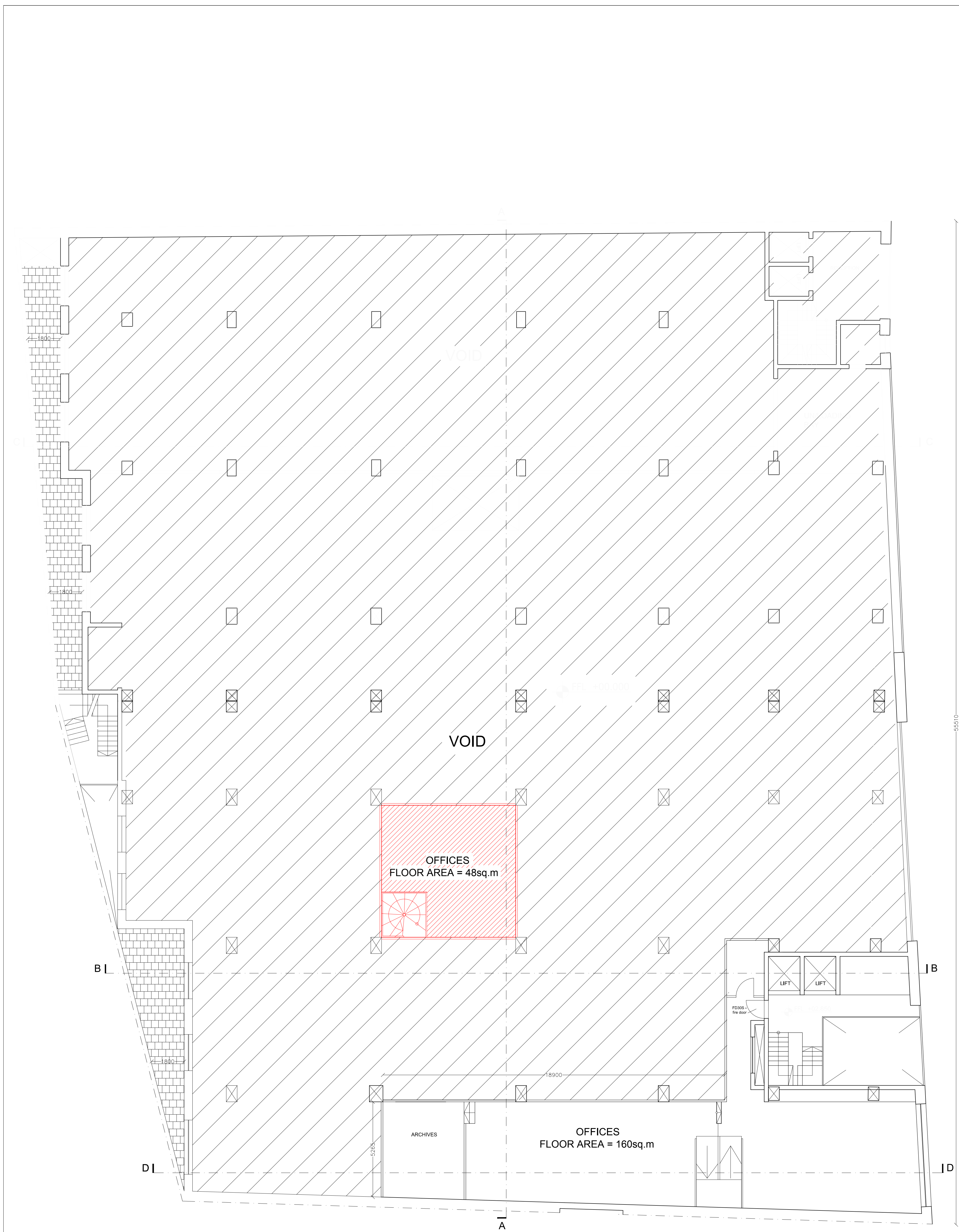

1 PROPOSED VS APPROVED INTERMEDIATE LEVEL
SCALE 1:100

| | | |
|--|---|--------------------------------------|
| Perit Ivan A. Bondin B.E.&A.(Hons.), M.Sc.(Edin.), A.&C.E. La Pietà, 3B, Triq ix-Xriek, Mgabba, MQB 1320. Tel: 21683147 Mob: 79594078 Mail: bondin@onvol.net | Job Description: Building of Ground floor premises to include commercial area Class 4b for retail sale of goods with an ancillary area for storage; 3 underlying basement garage levels and an extension to plot D to include a third underlying basement level | Scale: As shown Drawing Nr: A006A |
| | Title: Approved vs proposed drawings | Date: 01-12-16 Drawn by: IB |

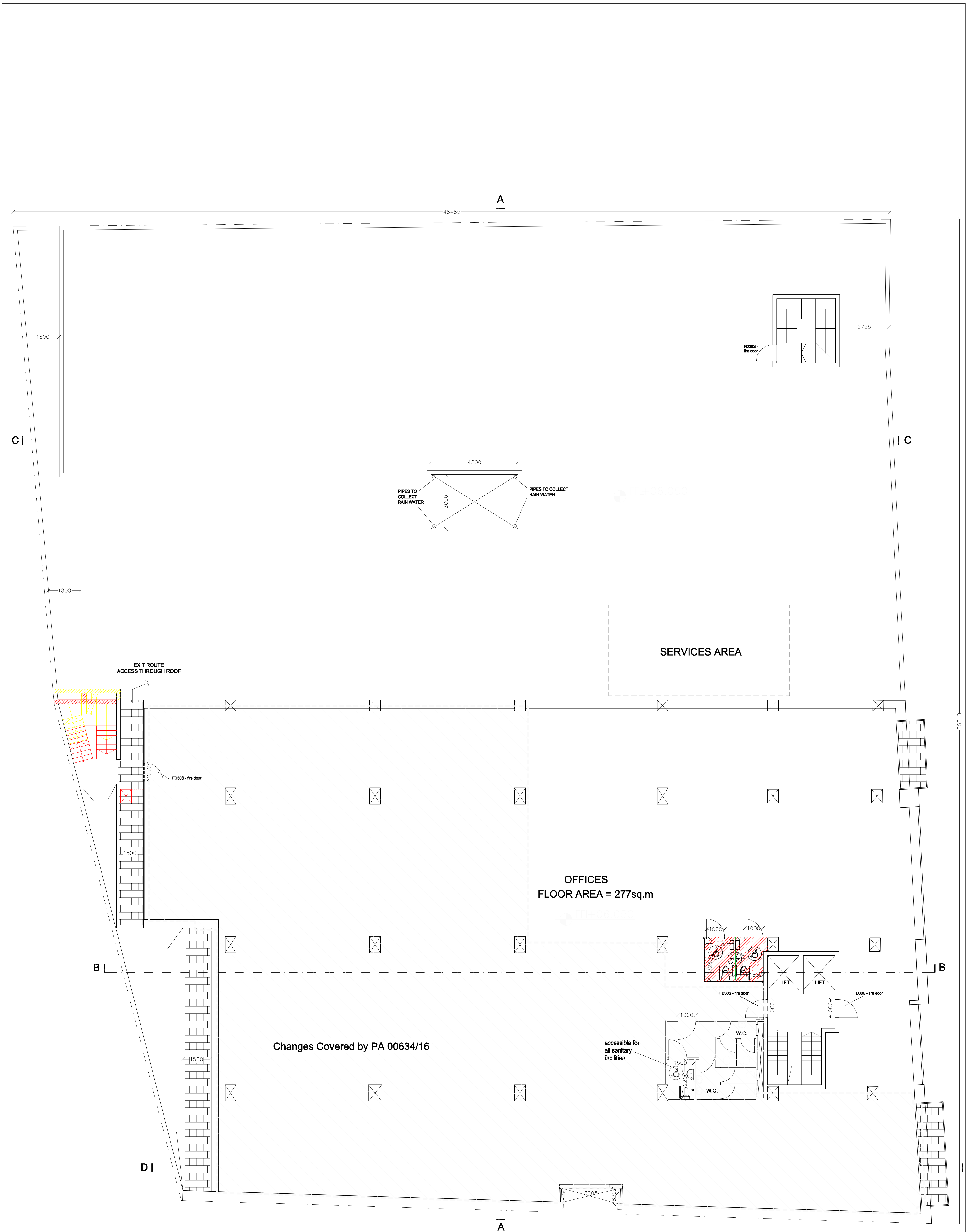

PROPOSED VS APPROVED LEVEL 1
SCALE 1:100

| | | |
|--|---|--|
| Perit Ivan A. Bondin B.E.&A. (Hons.), M.Sc. (Edin.), A.&C.E. La Pietà, 38, Triq ix-Xriek, Mgabba, MQB 1320. Tel: 21683147 Mob: 79594078 Mail: bondin@onvol.net | Job Description: Building of Ground floor premises to include commercial area Class 4b for retail sale of goods with an ancillary area for storage, 3 underlying basement garage levels and an extension to plot D to include a third underlying basement level Title: Approved vs proposed drawings | Scale: As shown |
| | | Drawing Nr: A004 Date: 07-03-2016 Drawn by: IB |

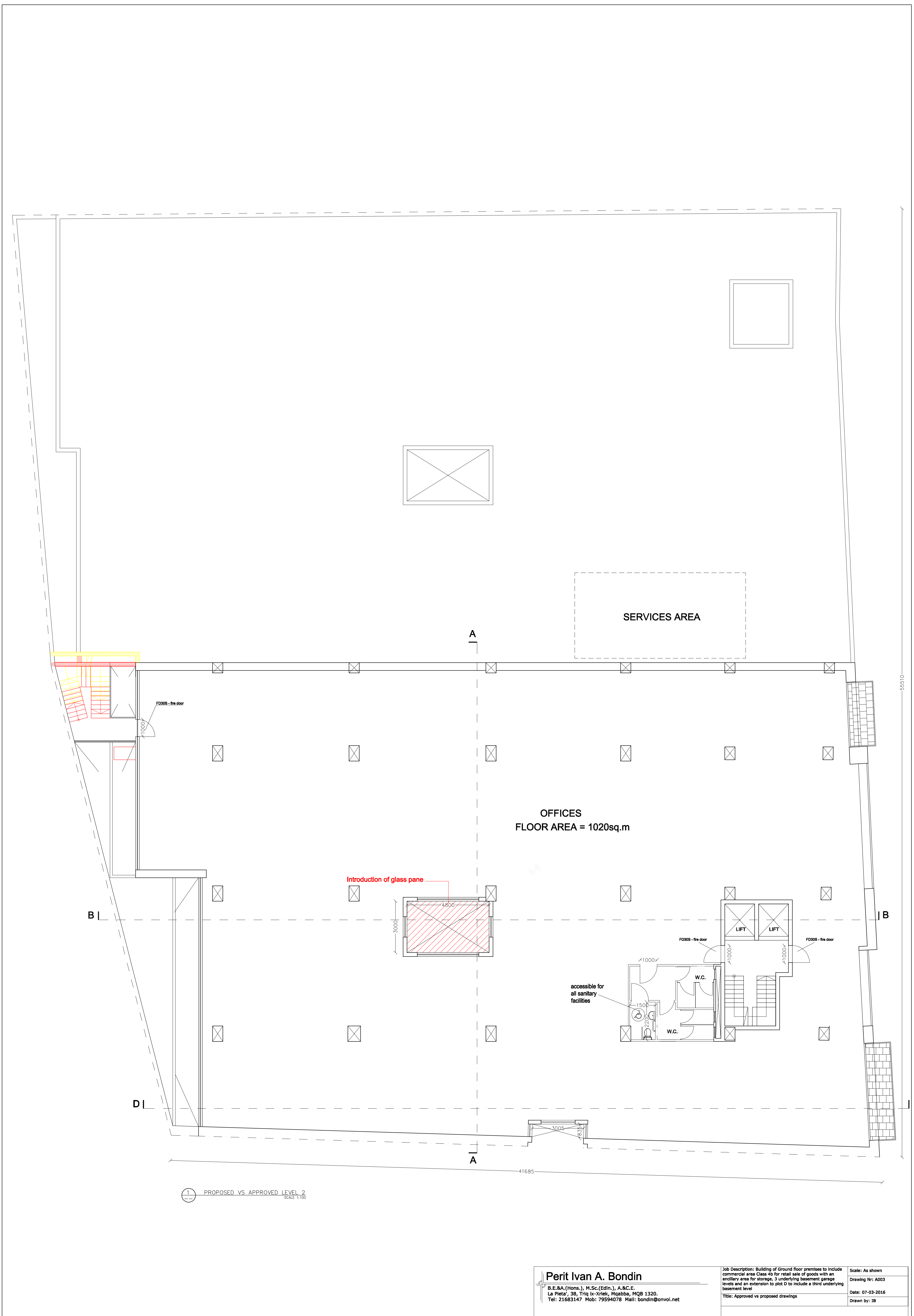

| | | |
|--|---|--|
| Perit Ivan A. Bondin B.E.&A.(Hons.), M.Sc.(Edin.), A.&C.E. La Pietà, 38, Triq ix-Xriek, Mgabba, MQB 1320. Tel: 21683147 Mob: 79594078 Mail: bondin@onvol.net | Job Description: Building of Ground floor premises to include commercial area Class 4b for retail sale of goods with an ancillary area for storage, 3 underlying basement garage levels and an extension to plot D to include a third underlying basement level Title: Approved vs proposed drawings | Scale: As shown |
| | | Drawing Nr: A003 Date: 07-03-2016 Drawn by: IB |

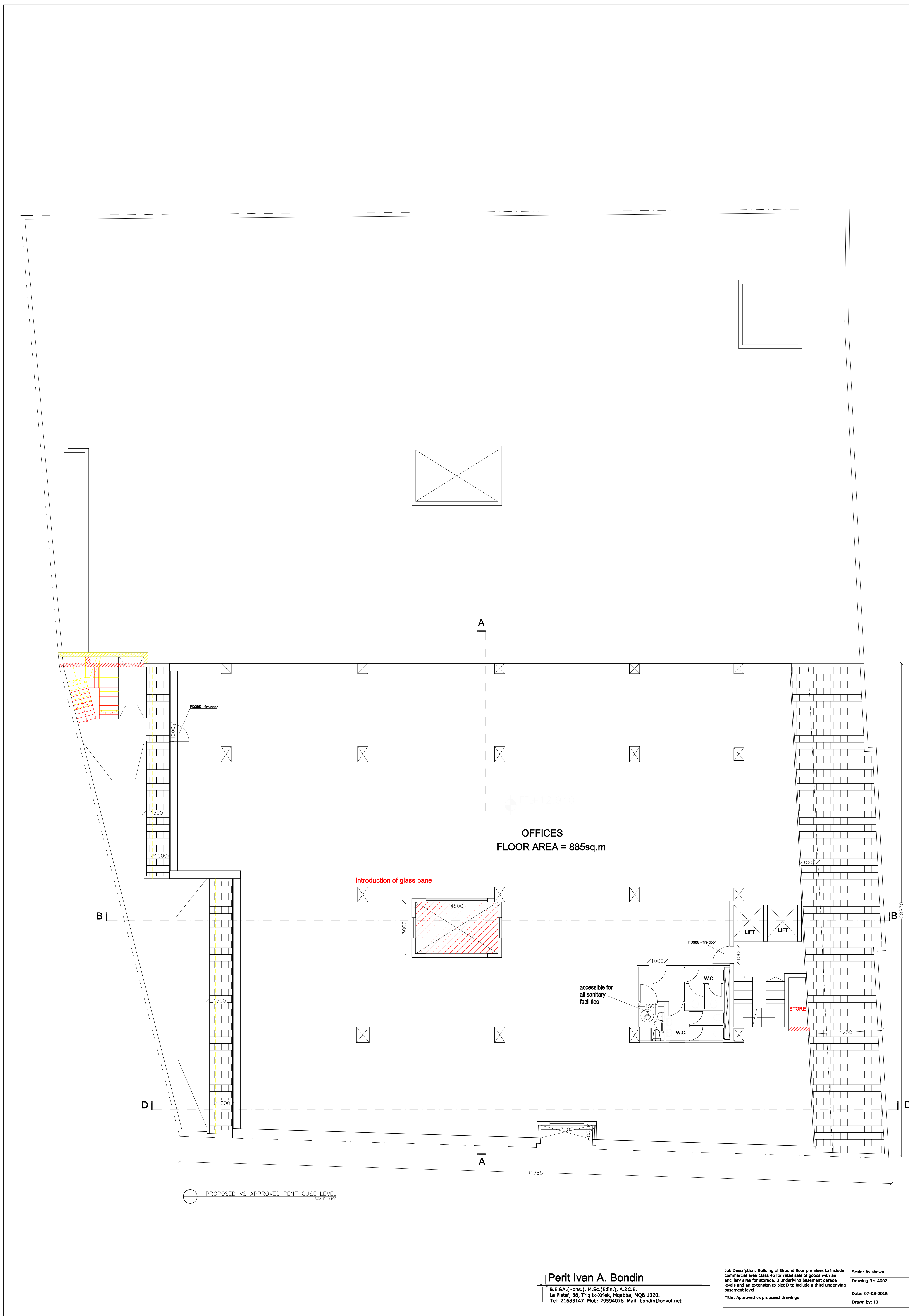

| | | |
|--|---|--|
| Perit Ivan A. Bondin B.E.&A. (Hons.), M.Sc. (Edin.), A.&C.E. La Pietà, 38, Triq ix-Xriek, Mgabba, MQB 1320. Tel: 21683147 Mob: 79594078 Mail: bondin@onvol.net | Job Description: Building of Ground floor premises to include commercial area Class 4b for retail sale of goods with an ancillary area for storage, 3 underlying basement garage levels and an extension to plot D to include a third underlying basement level Title: Approved vs proposed drawings | Scale: As shown |
| | | Drawing Nr: A002 Date: 07-03-2016 Drawn by: IB |

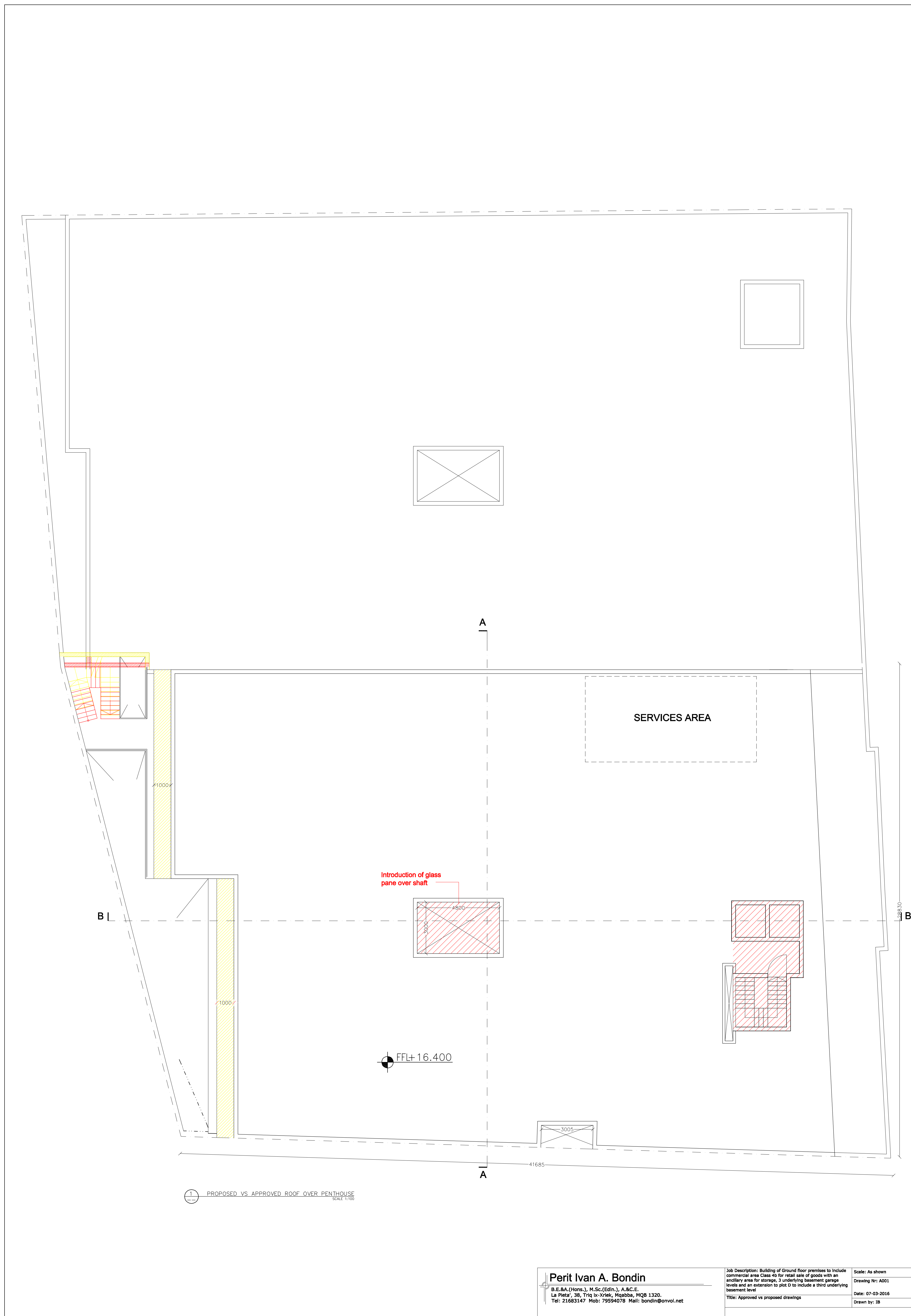

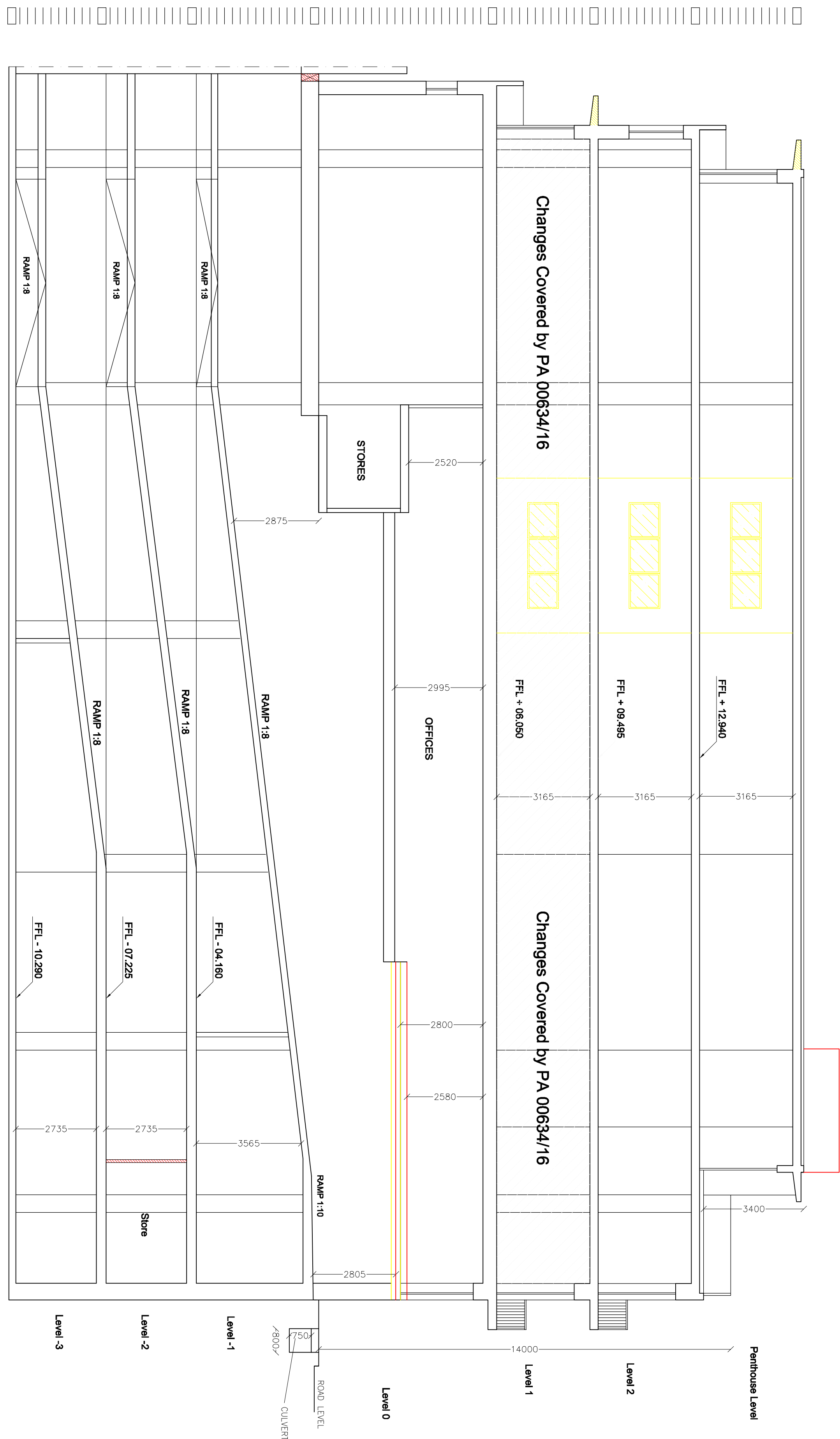

PROPOSED VS. APPROVED SECTION DD
SCALE: 1:100

Perit Ivan A. Bondin
R.E. 204 (1998), N.S.C. (2011), A.R.C. (1993), R.Q. 1320
Tel: 21653147 Mob: 75594078 Mail: bondin@bondin.net

Job Description: Building of ground floor premises to include commercial area Class 4b for retail sale of goods with an extension to plot D to include a shift underpinning basement level
Title: Approved vs proposed drawings

Scale: As shown
Drawing No: 2012
Date: 07-03-2016
Drawn by: JB

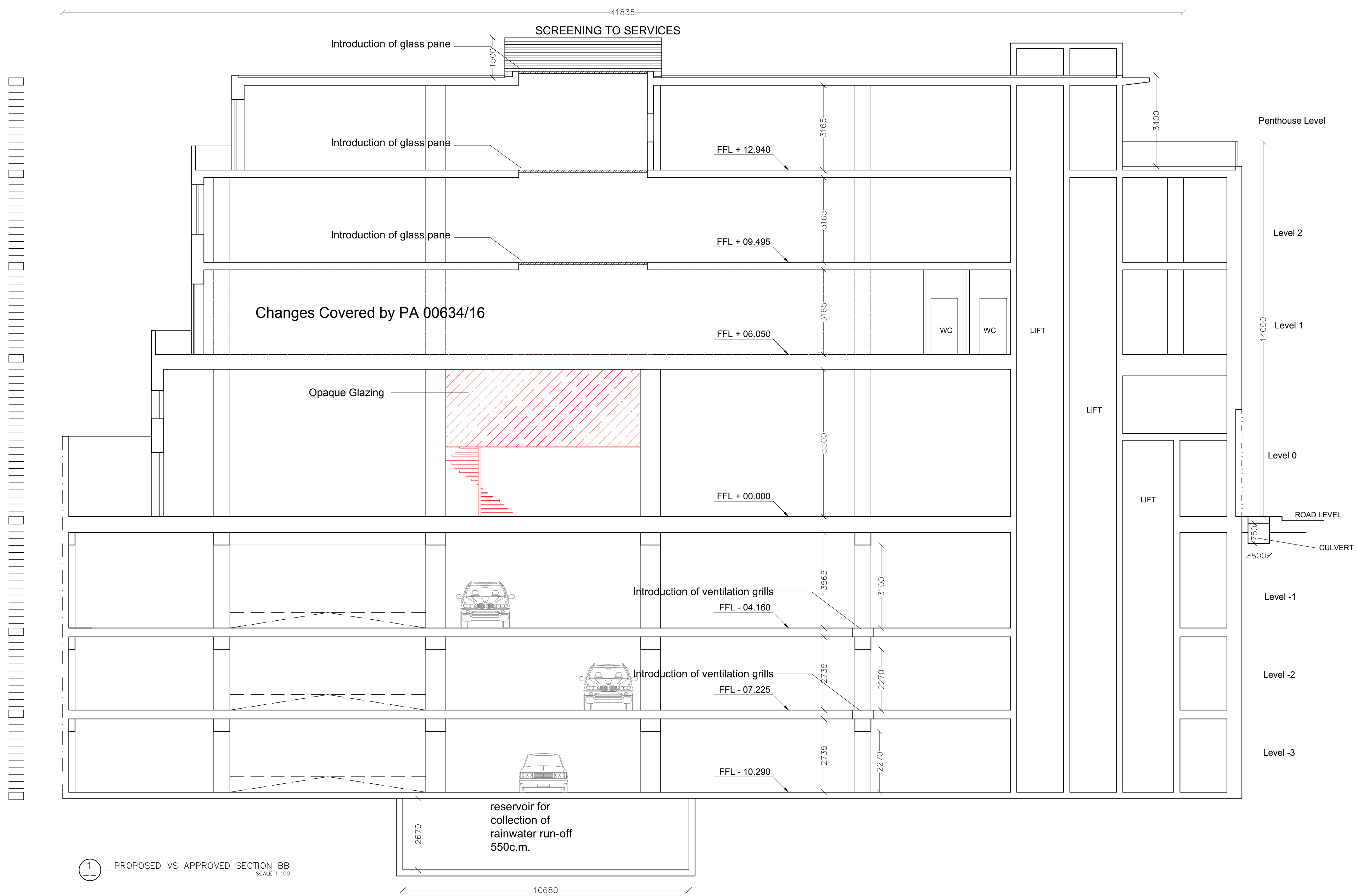

1 PROPOSED VS APPROVED SECTION BB
 SCALE 1:100

| | | |
|--|---|--------------------------------------|
| Perit Ivan A. Bondin B.E.&A.(Hons.), M.Sc.(Edin.), A.R.C.E. La Pietra, 38, Triq ix-Kriek, Mgabba, MQB 1320. Tel: 21683147 Mob: 79594078 Mail: bondin@onvol.net | Job Description: Building of Ground floor premises to include commercial area Class 4b for retail sale of goods with an ancillary area for storage, 3 underlying basement garage levels and an extension to plot D to include a third underlying basement level | Scale: As shown Drawing Nr: A010A |
| | Title: Approved vs proposed drawings | Date: 01-12-16 Drawn by: IB |

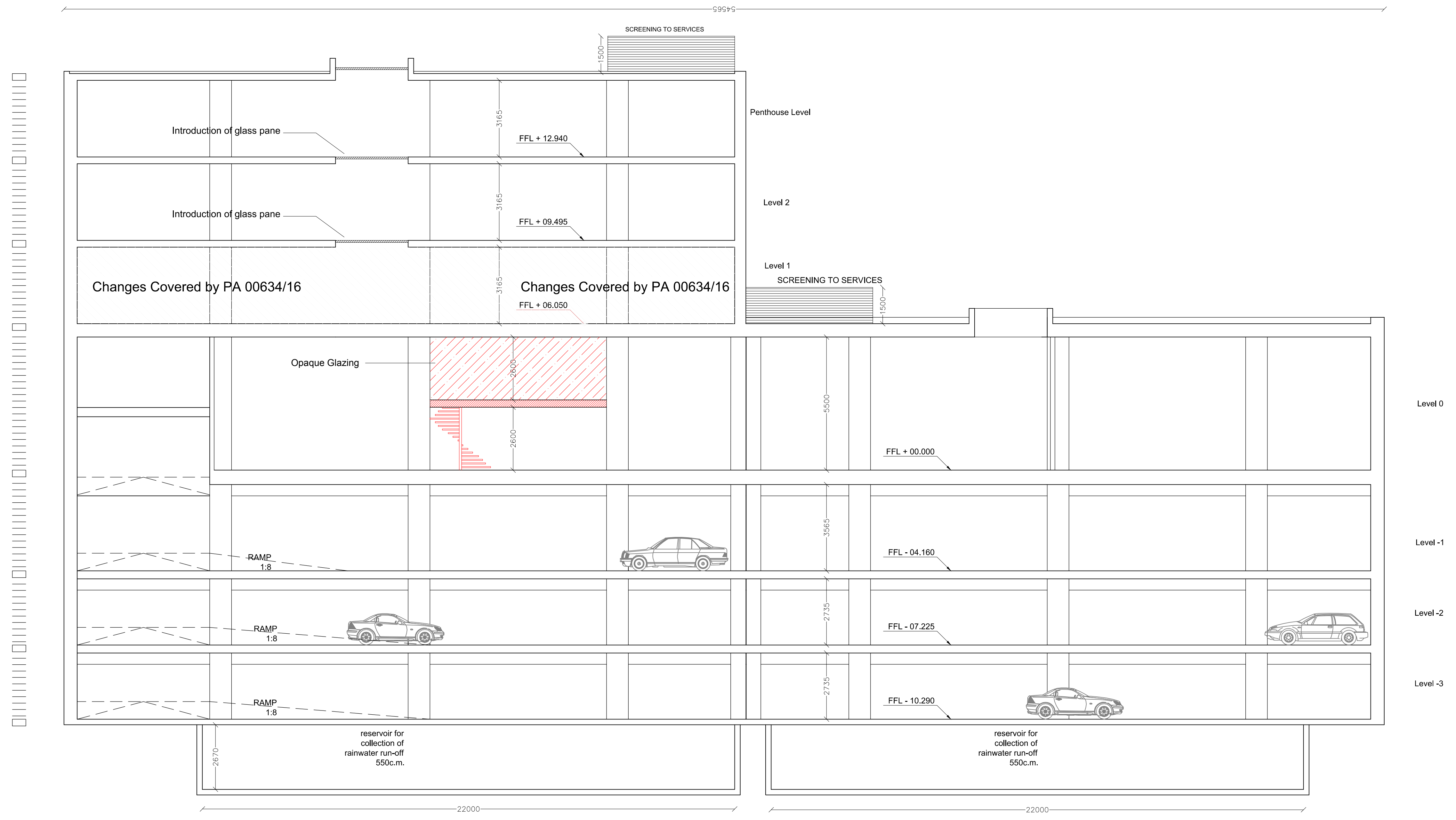

1 PROPOSED VS APPROVED SECTION AA
 SCALE 1:100

| | | |
|---|---|--------------------------------------|
| Perit Ivan A. Bondin B.E.&A.(Hons.), M.Sc.(Edm.), A.R.C.E. La Pietra, 38, Triq ix-Kriek, Mqabba, MQB 1320. Tel: 21683147 Mob: 79594078 Mail: bondin@onvol.net | Job Description: Building of Ground floor premises to include commercial area Class 4b for retail sale of goods with an ancillary area for storage, 3 underlying basement garage levels and an extension to plot D to include a third underlying basement level | Scale: As shown Drawing Nr: A011A |
| | Title: Approved vs proposed drawings | Date: 01-12-16 Drawn by: IB |

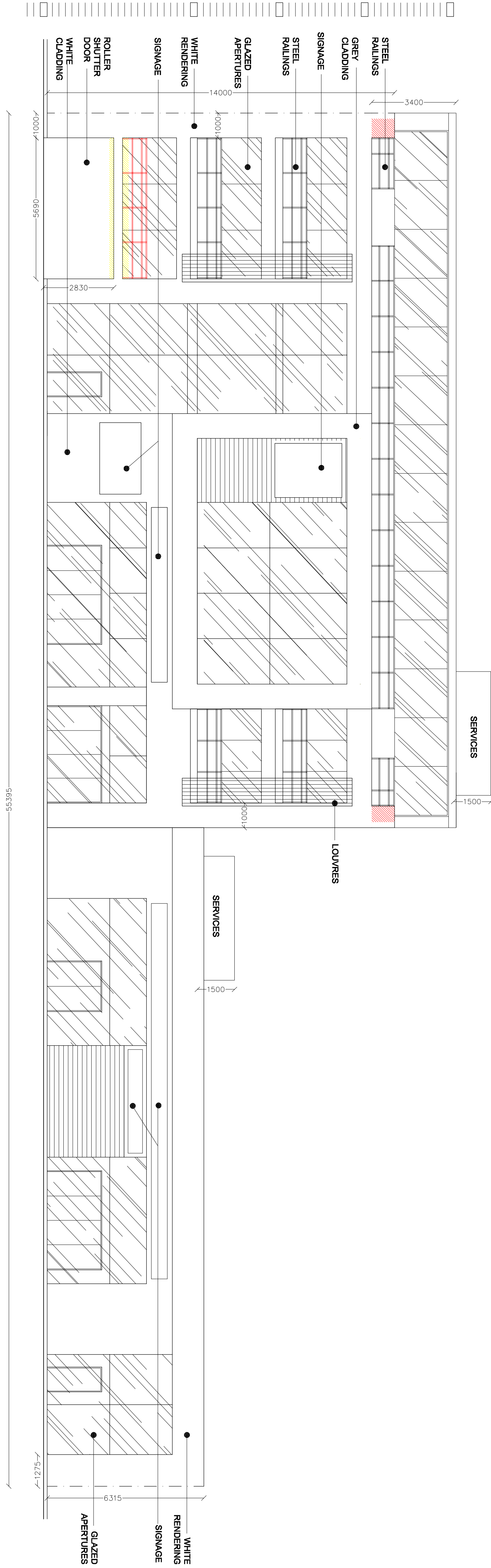

PROPOSED VS. APPROVED FRONT ELEVATION
SCALE: 1:100

Perit Ivan A. Bondin
 B.E. (Arch), M.Sc. (Edm.), A.A.C.E., M.Q.A. 1320
 Tel: 21653147 Mob: 75594078 Mail: bondin@bondin.net

Job Description: Building of ground floor premises to include commercial area of Class 4b for retail sale of goods with an extension to the existing building to include a third underground level and an extension to plot D to include a third underground level
 Title: Approved as proposed drawings

Scale: As shown
 Drawing No: 2013
 Date: 07-03-2016
 Drawn by: JB

Ms. Maria Bugeja
7
Cospicua Road
Zejtun ZTN 1726

Date: 9 August 2016
Our Ref: PA/00634/16

Application Number: PA/00634/16
Application Type: Full development permission
Date Received: 30 January 2016
Approved Documents: PA634/16/1A/78A/79A; and

Supporting Documents:
Fire Safety and Ventilation Report: PA634/16/68B/85A;
Superintendence of Public Health; PA634/16/60
Environmental Health Directorate: PA634/16/34A/46A; and
National Commission Persons with Disability: PA634/16/47A.

Location: Centris Business Centre, Triq Il- Palazz L- Ahmar, Birkirkara, Malta
Proposal: Change of use from offices to class 4c, gym class 3c, cosmetic clinics class 2a, beauty academy class 2c and beauty salon class 4b.

Development Planning Act, 2016 Full Development Permission

The Planning Authority hereby grants development permission in accordance with the application and documents described above, subject to the following conditions:

- 1 a) This development permission is valid for a period of FIVE YEARS from the date of publication of the decision in the press but will cease to be valid if the development is not completed by the end of this validity period.
- b) This permission relates only to the development as specifically indicated on the approved drawings. This permission does not sanction any other illegal development that may exist on the site.
- c) Copies of all approved drawings and documents shall be available for inspection on site by Planning Authority officers at all reasonable times.
- d) The development shall be carried out in complete accordance with the approved drawings, documents and conditions of this permission. Where a matter is not specified, then the conditions of this permission and of Development Control Design Policy, Guidance and Standards 2015 shall apply.
- e) Before any part of the development hereby permitted commences, the enclosed green

PA/00634/16

Print Date: 09/08/2016

copy of this development permission shall be displayed on the site. This must be mounted on a notice board, suitably protected from the weather and located not more than 2 metres above ground level at a point on the site boundary where it is clearly visible and can be easily read from the street. The copy of the permission must be maintained in a good condition and it shall remain displayed on the site until the works are completed.

f) A Commencement Notice is to be submitted to the Planning Authority, by the permit holder on behalf of the applicant, at least FIVE DAYS prior to the date of commencement of works or utilisation of the permission. Failure to submit the Commencement Notice (with all fields correctly completed) or to submit it within the required timeframe shall invalidate the Notice and shall result in the imposition of fines according to Schedule D of Legal Notice 277 of 2012, or its amendments, or its replacements. In addition, **if the applicant fails to submit the Commencement Notice or the Commencement Notice submitted is invalid, the relative permission shall be considered as never having been utilised** - Article 72(4) of the Development Planning Act (2016).

g) All building works shall be erected in accordance with the official alignment and official/existing finished road levels as set out on site by Planning Authority's Land Surveyor. The Setting Out Request Notice must be submitted to the Land Survey Unit of Planning Authority when the setting out of the alignment and levels is required.

h) Where an officially schemed street, within the development zone, bordering the site is unopened or unformed, it shall be opened up and brought up to its proper, approved and official formation levels prior to the commencement of any development hereby being permitted.

i) The development shall be carried out in accordance with the provisions of the Environmental Management Construction Site Regulations, Legal Notice 295 of 2007 (or subsequent amendments). Any hoarding shall be erected in accordance with Schedule 2 of the same Regulations.

j) Air conditioning units shall not be located on the facades of the building which are visible from the street or a public space.

k) There shall be no service pipes, cables or wires visible on the front elevation or on any other elevations of the building which are visible from the street or public space.

2 i) The approved premises shall be used as indicated on the approved drawings or as limited by any condition of this permission. If a change of use is permitted through the Development Planning (Use Classes) Order, 2014 (or its subsequent amendments), and it is not restricted by a condition of this permission, approval from the National Commission for Persons with Disability may still be required. Reference needs to be made to PA Circular 3/10 (with the exception of Appendix A), PA Circular 2/14 and their subsequent amendments.

ii) a) The approved Class 4C premises, as indicated in approved drawing PA634/16/78a, shall be used as a catering establishment for the preparation and sale of hot or cold food and drink for consumption on the premises where no cooking is allowed.

b) Equipment and other implements used to transform raw material into edible material through the process of heat shall not be used, kept or stored within the premises.

3 The development hereby permitted shall be subject to Final Compliance (Completion) Certification, verifying that the development has been carried out in full accordance with the approved drawings, documents and conditions imposed in this development permission. Prior to the issue of any compliance certificate on any part of this development, the applicant shall submit to Planning Authority, in relation to that part of the building:

(i) clearance from the National Commission for Persons with Disability verifying that the development fully satisfies the accessibility standards and/or any conditions imposed by the Commission in supporting document in PA634/16/47A.

Note: Should a partial compliance certificate be requested, a Bank Guarantee of EUR 10,000 shall apply to ensure that KNPD clearance is obtained

(ii) certification from a qualified engineer confirming that the development fully satisfies the requirements specified in supporting document Fire Safety and Ventilation Report in PA634/16/68B/85A.

4 The conditions imposed and enforced by the Environmental Health Directorate are at supporting documents PA634/16/34A/46A. The architect/applicant is required to contact the Environmental Health Directorate, throughout the implementation of the development hereby approved, to ensure conformity with the imposed conditions. A copy of the relative correspondence / clearance shall be submitted to Planning Authority accordingly.

In terms of Article 72(3) of the Development Planning Act, 2016, the execution and validity of this permission is automatically temporarily **suspended** and no works as approved by the said development permission may commence before the lapse of the time period established in Article 13 of the Environment and Planning Review Tribunal Act and subsequently will remain so suspended if the Tribunal so decides in accordance with the Environment and Planning Review Tribunal Act.

Where the approved drawings and/or documents are dimensioned, then the declared dimensions shall prevail over the actual size as depicted on the approved drawings and/or documents.

Developers are advised to check the invert level to the sewer main with the Water Services Corporation as they would have to make their own arrangements where a gravity service connection is not possible. In these cases, the architect has to indicate the solutions envisaged and to indicate on the plan what needs to be carried out and obtain approval from WSC. Developers are further reminded that connection of storm water into main sewers is not allowed.

If the declaration of ownership, as contained in the application form, is determined as incorrect by a Court of Law, then the said Court of Law can declare this development permission as null and void. This development permission does not remove or replace the need to obtain the consent of the land/building owner to this development before it is carried out. Furthermore, it does not imply that consent will necessarily be forthcoming nor does it bind the land/building owner to agree to this development. Where the land/building is owned or administered by the Government of Malta a specific clearance and agreement must be obtained for this development from the Land and/or Estate Management Departments.

This development permission is granted saving third party rights. This permission does not exonerate
PA/00634/16 Print Date: 09/08/2016

the applicant from obtaining any other necessary permission, license, clearance or approval required from any Government department, local council, agency or authority, as required by any law or regulation.

This development permit does not authorise any storage of substances listed in Occupational Health and Safety Authority Act (Cap. 424) - Control of Major Accident Hazards Regulations, 2003, as amended, in quantities that would render this site an establishment within scope of these regulations. The storage and handling of said substances may require a new or amended development permission in line with current policies and regulations.

For any non-residential uses hereby being approved, prior to commencement of any works on site or any eventual permitted change of use, the applicant shall be required to contact the Environment and Resources Authority to obtain any necessary operational permit or registration. This requirement does not apply to Class 2B, 2C, 4A and 4B uses as listed in the Development Planning (Use Classes) Order 2014, or its subsequent amendments.

This decision is being published on 24 August 2016.

Claudine Faure
Secretary Planning Commission (Development Permissions)

Notes to Applicant and Perit

Right for reconsideration

Where applicable, you have a right to submit a request for reconsideration to the Authority in terms of regulation 14 of Legal Notice 162 of 2016.

Right for appeal

You have a right to submit an appeal, against the decision, to the Environment and Planning Review Tribunal in terms of Article 13 of the Environment and Planning Review Tribunal Act, 2016.

Time limits

Requests for reconsideration or appeals must be made within 30 days from the publication of the decision notification in the local press as required by regulation 14(1) of Legal Notice 162 of 2016.

Fees to submit a request for reconsideration or appeal

In either case, there is a fee to be paid which should accompany the request for reconsideration or the appeal. The fees are as follows:

For reconsideration - 3% of the Development Permit Fee paid in respect of the original application, subject to a minimum of €69.88.

For appeal - 5% of DPF (Development Permit Fee) paid in respect of the original application, subject to a minimum of €150 + €50 administrative fee (LN 112 of 2016).

Submission of request for reconsideration or appeal

With regards to requests for reconsideration, Form PA 4/16 must be used for submission. All fields of the Form must be filled in as appropriate. Requests for reconsideration can only be submitted electronically.

With regards to appeals, as required by Article 13 of the Environment and Planning Review Tribunal Act, 2016, the submission must include the detailed grounds for appeal and the requests being made by the appellant. Appeals must be submitted physically at the offices of the Environment and Planning Review Tribunal, St. Francis Ditch, Floriana.

Important Notice

In view of the provisions of Article 72(4) of the Development Planning Act (2016), a Commencement Notice is to be submitted to the Planning Authority, by the perit on behalf of the applicant, at least FIVE DAYS prior to the date of commencement of works or utilisation of the permission. Failure to submit the Commencement Notice (with all fields correctly completed) or failure to submit it within the required timeframe shall invalidate the Notice and shall result in the imposition of fines according to Schedule D of Legal Notice 277 of 2012, or its amendments, or its replacements. In addition, if the applicant fails to submit the Commencement Notice or the Commencement Notice submitted is invalid, the relative permission shall be considered as never having been utilised.

-PADCN-

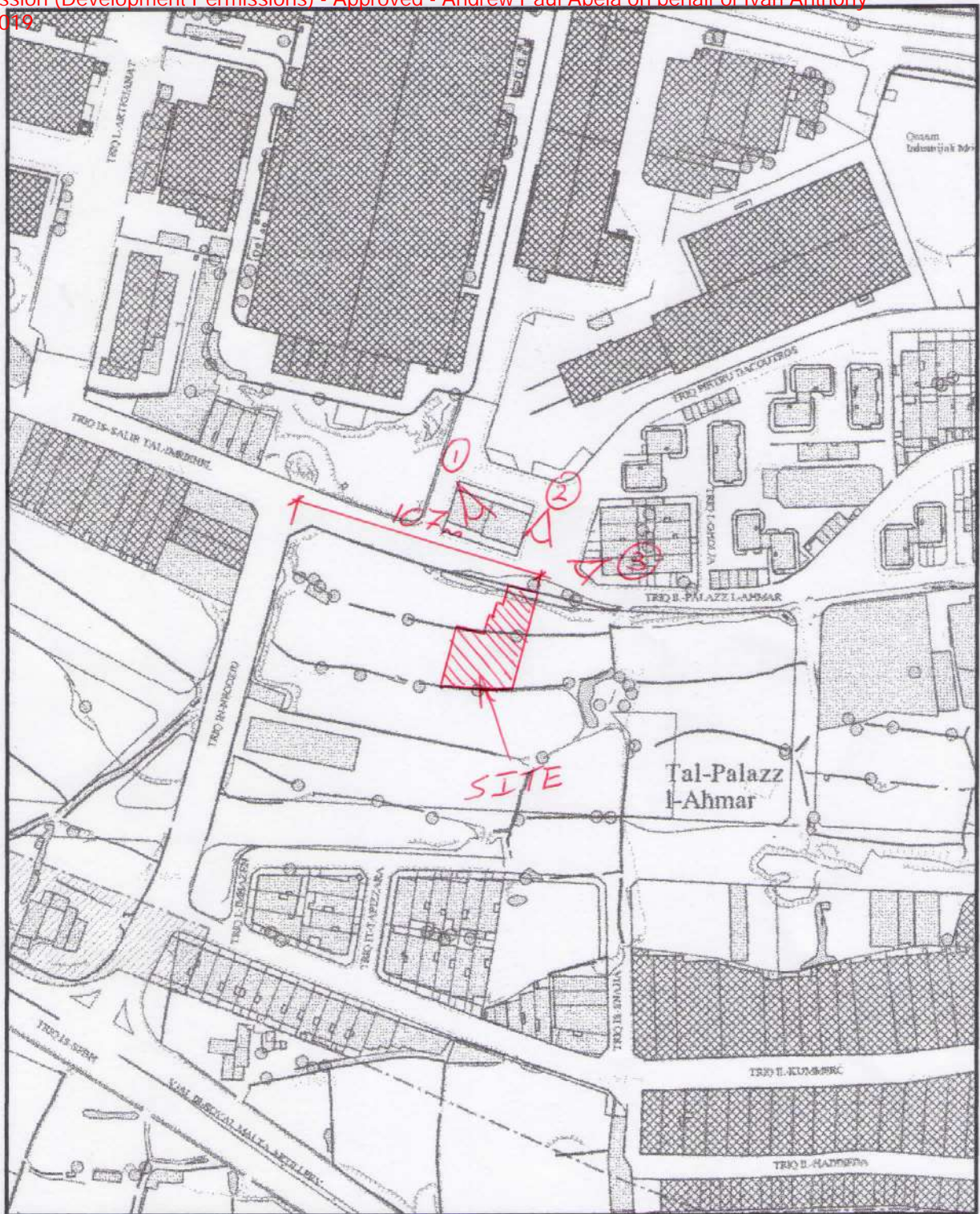

Min Easting 52021.35, Min Northing 71586.8, Max Easting 52421.35, Max Northing 72086.8

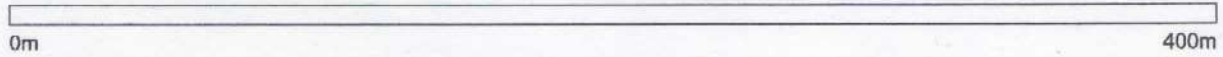

MEPA - www.mepa.org.mt

St. Francis Ravelin
Floriana FRN 1230, Malta
PO Box 200, Marsa MRS 1000, Malta
Tel: +356 2290 0000 Fax: +356 22902295

Site Plan, Scale 1:2500

Printed on: Saturday, January 30, 2016

Not to be used for interpretation or scaling of scheme alignments
Copyright © MEPA - Malta Environment & Planning Authority. Not for resale.



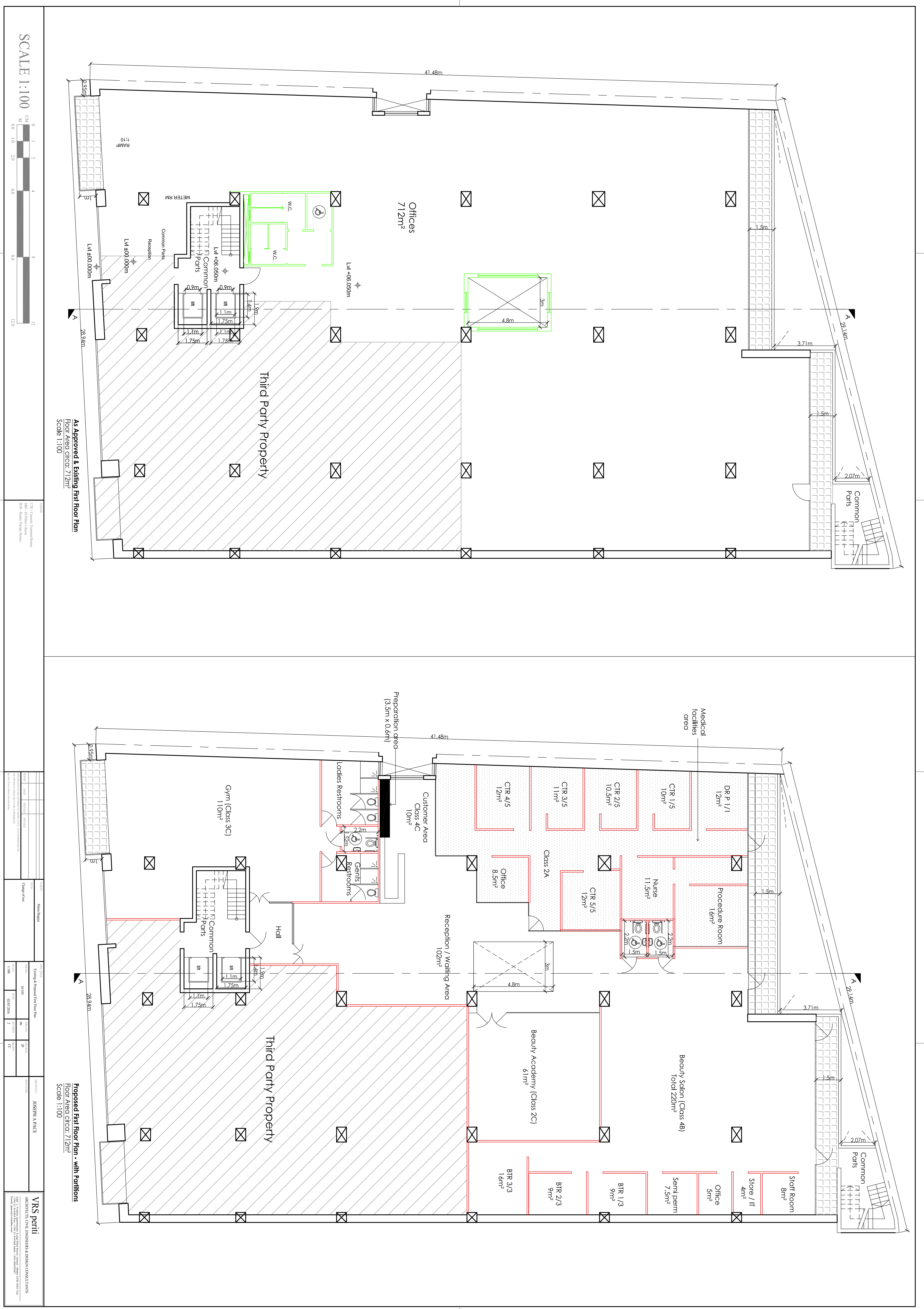

SCALE 1:100

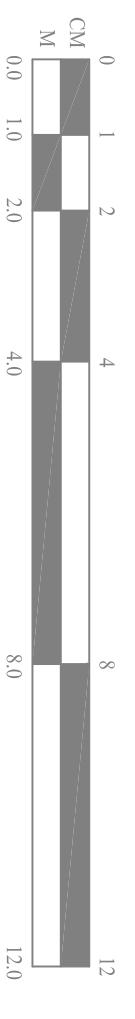

As Approved & Existing First Floor Plan
Floor Area Office: 712m²
Scale 1:100

Proposed First Floor Plan - with Partitions
Floor Area Office: 712m²
Scale 1:100

| | | | |
|------------|--------------------------------------|--------|---------|
| DATE | DESCRIPTION | BY | CHECKED |
| 17/06/2019 | Final Design | J.P.A. | J.P.A. |
| 16/06/2019 | Change of use | J.P.A. | J.P.A. |
| 11/06/2019 | Existing & Proposed First Floor Plan | J.P.A. | J.P.A. |

| | |
|--------------------------------------|----------------|
| PROJECT | CLIENT |
| Existing & Proposed First Floor Plan | JOSEPH A. PACE |
| SCALE | DATE |
| 1:100 | 17/06/2019 |
| 1:100 | 16/06/2019 |
| 1:100 | 11/06/2019 |

| | |
|---|--------------------------------------|
| DESIGNER | PROJECT |
| VRS periti | Existing & Proposed First Floor Plan |
| ARCHITECTS, CIVIL ENGINEERS & DESIGN CONSULTANTS | JOSEPH A. PACE |
| 100, 101, 102, 103, 104, 105, 106, 107, 108, 109, 110, 111, 112, 113, 114, 115, 116, 117, 118, 119, 120, 121, 122, 123, 124, 125, 126, 127, 128, 129, 130, 131, 132, 133, 134, 135, 136, 137, 138, 139, 140, 141, 142, 143, 144, 145, 146, 147, 148, 149, 150, 151, 152, 153, 154, 155, 156, 157, 158, 159, 160, 161, 162, 163, 164, 165, 166, 167, 168, 169, 170, 171, 172, 173, 174, 175, 176, 177, 178, 179, 180, 181, 182, 183, 184, 185, 186, 187, 188, 189, 190, 191, 192, 193, 194, 195, 196, 197, 198, 199, 200 | |



As Approved, Existing & Proposed Section A-A
Scale 1:100

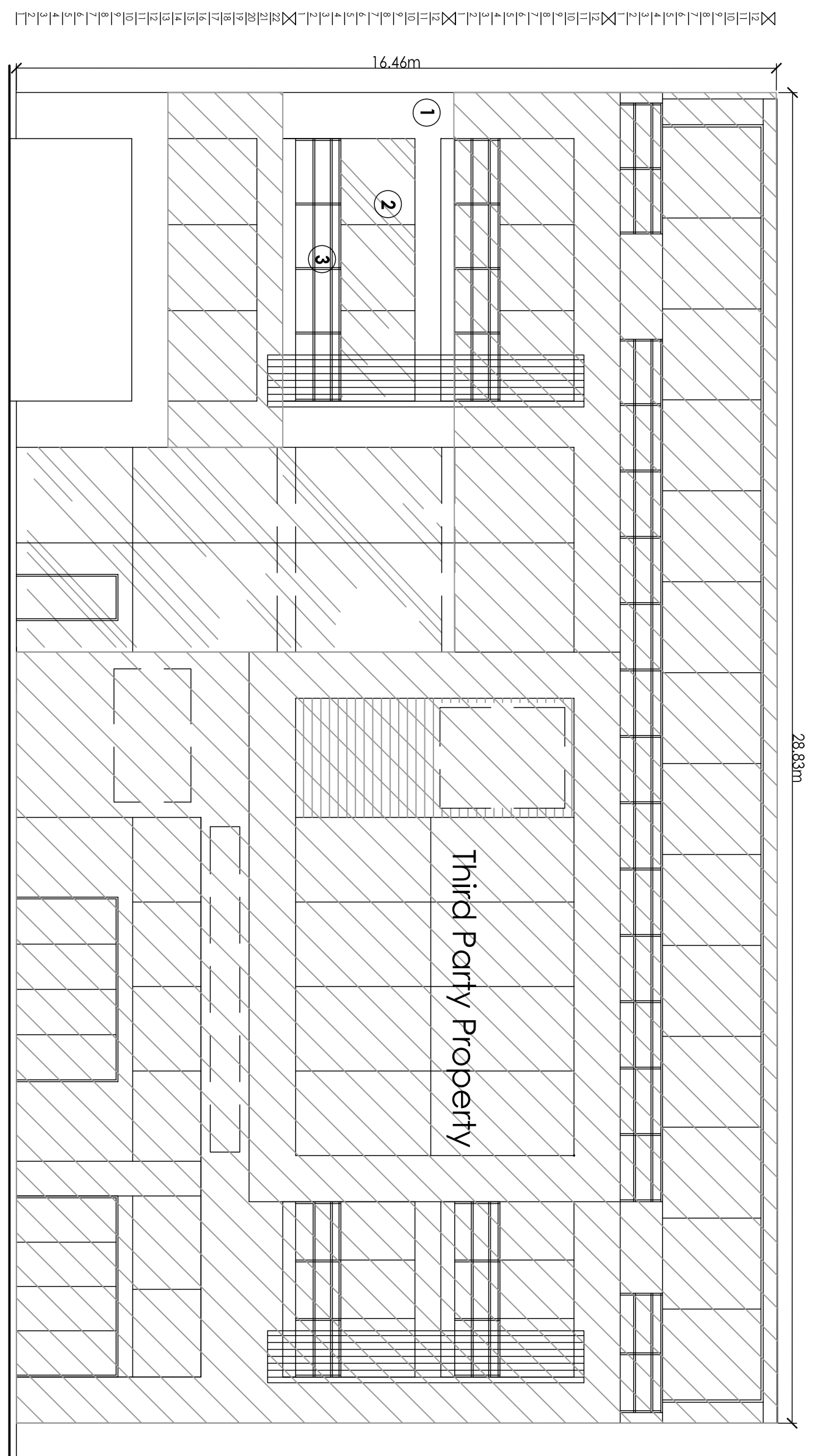

As Approved & Existing Elevation (no changes to elevation)
Scale 1:100

SCALE 1:100

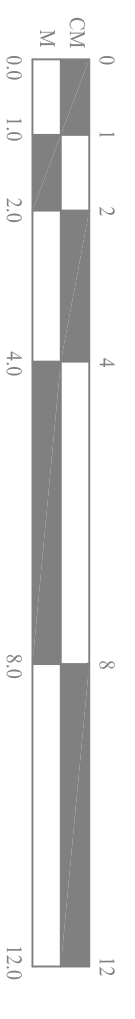

- LEGEND:
- 1 - White Rendering
 - 2 - Closed Apertures
 - 3 - Steel Riling

| NO. | DATE | DESCRIPTION | BY | CHECKED |
|-----|------------|---------------|----|---------|
| 1 | 16/03/2019 | Change of use | JP | JP |

| | |
|---------------|--|
| PROJECT TITLE | As Approved, Existing & Proposed Section & Elevation |
| CLIENT | JOSEPH A. PACE |

| | |
|-------------|------------|
| DATE | 17/06/2019 |
| SCALE | 1:100 |
| PROJECT NO. | 1 |

VRS periti
ARCHITECTS, CIVIL ENGINEERS & DESIGN CONSULTANTS
100, 101, 102, 103, 104, 105, 106, 107, 108, 109, 110, 111, 112, 113, 114, 115, 116, 117, 118, 119, 120, 121, 122, 123, 124, 125, 126, 127, 128, 129, 130, 131, 132, 133, 134, 135, 136, 137, 138, 139, 140, 141, 142, 143, 144, 145, 146, 147, 148, 149, 150, 151, 152, 153, 154, 155, 156, 157, 158, 159, 160, 161, 162, 163, 164, 165, 166, 167, 168, 169, 170, 171, 172, 173, 174, 175, 176, 177, 178, 179, 180, 181, 182, 183, 184, 185, 186, 187, 188, 189, 190, 191, 192, 193, 194, 195, 196, 197, 198, 199, 200, 201, 202, 203, 204, 205, 206, 207, 208, 209, 210, 211, 212, 213, 214, 215, 216, 217, 218, 219, 220, 221, 222, 223, 224, 225, 226, 227, 228, 229, 230, 231, 232, 233, 234, 235, 236, 237, 238, 239, 240, 241, 242, 243, 244, 245, 246, 247, 248, 249, 250, 251, 252, 253, 254, 255, 256, 257, 258, 259, 260, 261, 262, 263, 264, 265, 266, 267, 268, 269, 270, 271, 272, 273, 274, 275, 276, 277, 278, 279, 280, 281, 282, 283, 284, 285, 286, 287, 288, 289, 290, 291, 292, 293, 294, 295, 296, 297, 298, 299, 300, 301, 302, 303, 304, 305, 306, 307, 308, 309, 310, 311, 312, 313, 314, 315, 316, 317, 318, 319, 320, 321, 322, 323, 324, 325, 326, 327, 328, 329, 330, 331, 332, 333, 334, 335, 336, 337, 338, 339, 340, 341, 342, 343, 344, 345, 346, 347, 348, 349, 350, 351, 352, 353, 354, 355, 356, 357, 358, 359, 360, 361, 362, 363, 364, 365, 366, 367, 368, 369, 370, 371, 372, 373, 374, 375, 376, 377, 378, 379, 380, 381, 382, 383, 384, 385, 386, 387, 388, 389, 390, 391, 392, 393, 394, 395, 396, 397, 398, 399, 400, 401, 402, 403, 404, 405, 406, 407, 408, 409, 410, 411, 412, 413, 414, 415, 416, 417, 418, 419, 420, 421, 422, 423, 424, 425, 426, 427, 428, 429, 430, 431, 432, 433, 434, 435, 436, 437, 438, 439, 440, 441, 442, 443, 444, 445, 446, 447, 448, 449, 450, 451, 452, 453, 454, 455, 456, 457, 458, 459, 460, 461, 462, 463, 464, 465, 466, 467, 468, 469, 470, 471, 472, 473, 474, 475, 476, 477, 478, 479, 480, 481, 482, 483, 484, 485, 486, 487, 488, 489, 490, 491, 492, 493, 494, 495, 496, 497, 498, 499, 500, 501, 502, 503, 504, 505, 506, 507, 508, 509, 510, 511, 512, 513, 514, 515, 516, 517, 518, 519, 520, 521, 522, 523, 524, 525, 526, 527, 528, 529, 530, 531, 532, 533, 534, 535, 536, 537, 538, 539, 540, 541, 542, 543, 544, 545, 546, 547, 548, 549, 550, 551, 552, 553, 554, 555, 556, 557, 558, 559, 560, 561, 562, 563, 564, 565, 566, 567, 568, 569, 570, 571, 572, 573, 574, 575, 576, 577, 578, 579, 580, 581, 582, 583, 584, 585, 586, 587, 588, 589, 590, 591, 592, 593, 594, 595, 596, 597, 598, 599, 600, 601, 602, 603, 604, 605, 606, 607, 608, 609, 610, 611, 612, 613, 614, 615, 616, 617, 618, 619, 620, 621, 622, 623, 624, 625, 626, 627, 628, 629, 630, 631, 632, 633, 634, 635, 636, 637, 638, 639, 640, 641, 642, 643, 644, 645, 646, 647, 648, 649, 650, 651, 652, 653, 654, 655, 656, 657, 658, 659, 660, 661, 662, 663, 664, 665, 666, 667, 668, 669, 670, 671, 672, 673, 674, 675, 676, 677, 678, 679, 680, 681, 682, 683, 684, 685, 686, 687, 688, 689, 690, 691, 692, 693, 694, 695, 696, 697, 698, 699, 700, 701, 702, 703, 704, 705, 706, 707, 708, 709, 710, 711, 712, 713, 714, 715, 716, 717, 718, 719, 720, 721, 722, 723, 724, 725, 726, 727, 728, 729, 730, 731, 732, 733, 734, 735, 736, 737, 738, 739, 740, 741, 742, 743, 744, 745, 746, 747, 748, 749, 750, 751, 752, 753, 754, 755, 756, 757, 758, 759, 760, 761, 762, 763, 764, 765, 766, 767, 768, 769, 770, 771, 772, 773, 774, 775, 776, 777, 778, 779, 780, 781, 782, 783, 784, 785, 786, 787, 788, 789, 790, 791, 792, 793, 794, 795, 796, 797, 798, 799, 800, 801, 802, 803, 804, 805, 806, 807, 808, 809, 810, 811, 812, 813, 814, 815, 816, 817, 818, 819, 820, 821, 822, 823, 824, 825, 826, 827, 828, 829, 830, 831, 832, 833, 834, 835, 836, 837, 838, 839, 840, 841, 842, 843, 844, 845, 846, 847, 848, 849, 850, 851, 852, 853, 854, 855, 856, 857, 858, 859, 860, 861, 862, 863, 864, 865, 866, 867, 868, 869, 870, 871, 872, 873, 874, 875, 876, 877, 878, 879, 880, 881, 882, 883, 884, 885, 886, 887, 888, 889, 890, 891, 892, 893, 894, 895, 896, 897, 898, 899, 900, 901, 902, 903, 904, 905, 906, 907, 908, 909, 910, 911, 912, 913, 914, 915, 916, 917, 918, 919, 920, 921, 922, 923, 924, 925, 926, 927, 928, 929, 930, 931, 932, 933, 934, 935, 936, 937, 938, 939, 940, 941, 942, 943, 944, 945, 946, 947, 948, 949, 950, 951, 952, 953, 954, 955, 956, 957, 958, 959, 960, 961, 962, 963, 964, 965, 966, 967, 968, 969, 970, 971, 972, 973, 974, 975, 976, 977, 978, 979, 980, 981, 982, 983, 984, 985, 986, 987, 988, 989, 990, 991, 992, 993, 994, 995, 996, 997, 998, 999, 1000

Mr Kurt Abela
KA Holdings Ltd
Project Technik
Cannon Road
Qormi QRM 9032

Date: 1 June 2017
Our Ref: PA/01433/17

Application Number: PA/01433/17
Application Type: Full development permission
Date Received: 7 December 2016
Approved Documents: PA 1433/17/1A/41A/41B/41C/41D/41E; and supporting documents
Engineer's Light and Ventilation Report - PA 1433/17/46A/101A;
Accessibility Audit Report - PA 1433/17/45A

Location: Centris Plot C and D, Triq Il-Palazz I-Ahmar, Birkirkara, Malta
Proposal: Alterations and additions to PA 0224/14. Changes relate mainly to the extension of the intermediate level for additional Category D Class 4A facilities to be created.

Development Planning Act, 2016 Full Development Permission

The Planning Authority hereby grants development permission in accordance with the application and documents described above, subject to the following conditions:

- 1 a) This development permission is valid for a period of FIVE YEARS from the date of publication of the decision in the press but will cease to be valid if the development is not completed by the end of this validity period.
- b) This permission relates only to the development as specifically indicated on the approved drawings. This permission does not sanction any other illegal development that may exist on the site.
- c) Copies of all approved drawings and documents shall be available for inspection on site by Planning Authority officers at all reasonable times.
- d) The development shall be carried out in complete accordance with the approved drawings, documents and conditions of this permission. Where a matter is not specified, then the conditions of this permission and of Development Control Design Policy, Guidance and Standards 2015 shall apply.
- e) Before any part of the development hereby permitted commences, the enclosed green copy of this development permission shall be displayed on the site. This must be mounted on a notice board, suitably protected from the weather and located not more than 2 metres above ground level at a point on the site boundary where it is clearly visible

PA/01433/17

Print Date: 03/08/2017

and can be easily read from the street. The copy of the permission must be maintained in a good condition and it shall remain displayed on the site until the works are completed.

f) A Commencement Notice is to be submitted to the Planning Authority, by the permit on behalf of the applicant, at least FIVE DAYS prior to the date of commencement of works or utilisation of the permission. Failure to submit the Commencement Notice (with all fields correctly completed) or failure to submit it within the required timeframe shall invalidate the Notice and shall result in the imposition of fines according to Schedule D of Legal Notice 277 of 2012, or its amendments, or its replacements. In addition, **if the applicant fails to submit the Commencement Notice or the Commencement Notice submitted is invalid, the relative permission shall be considered as never having been utilised** - Article 72(4) of the Development Planning Act (2016).

g) All building works shall be erected in accordance with the official alignment and official/existing finished road levels as set out on site by the Planning Authority's Land Surveyor. The Setting Out Request Notice must be submitted to the Land Survey Unit of the Planning Authority when the setting out of the alignment and levels is required.

h) The development shall be carried out in accordance with the provisions of the Environmental Management Construction Site Regulations, Legal Notice 295 of 2007 (or subsequent amendments). Any hoarding shall be erected in accordance with Schedule 2 of the same Regulations.

i) No steps, ramps or street furniture are to be constructed on or encroached onto the public pavement or road.

j) Any doors and windows, the lower edge of which is less than 2m above road level, and any gates shall not open outwards onto a public pavement or road.

k) Air conditioning units shall not be located on the facades of the building which are visible from the street or a public space.

l) There shall be no service pipes, cables or wires visible on the front elevation or on any other elevations of the building which are visible from the street or public space.

2 a) The façade(s) of the building shall be constructed in local un-rendered and unpainted stone, except where other materials/finishes are indicated on the approved drawings.

b) All the apertures and balconies located on the façade(s) of the building shall not be in gold, silver or bronze aluminium.

3 The approved premises shall be used as indicated on the approved drawings or as limited by any condition of this permission. If a change of use is permitted through the Development Planning (Use Classes) Order, 2014 (or its subsequent amendments), and it is not restricted by a condition of this permission, approval from the Commission for the Rights of Persons with Disability may still be required. Reference needs to be made to PA Circular 3/10 (with the exception of Appendix A), PA Circular 2/14 and their subsequent amendments.

No industrial activities apart from the required warehousing should be carried out on site. Any activities such as maintenance and servicing of vehicles, manufacturing, spray painting etc. shall require a submission of a new planning application for the required

change of use.

- 4 The development hereby permitted shall be subject to Final Compliance (Completion) Certification, verifying that the development has been carried out in full accordance with the approved drawings, documents and conditions imposed in this development permission, except where such conditions are enforced by other entities. Prior to the issue of any compliance certificate on any part of this development, the applicant shall submit to the Planning Authority, in relation to that part of the building:

(i) certification from a qualified engineer confirming that the development fully satisfies the requirements specified in supporting document PA 1433/17/46A/101A;

(ii) clearance from the Commission for the Rights of Persons with Disability verifying that the development fully satisfies the accessibility standards and/or any conditions imposed by the Commission in supporting document PA 1433/17/45A.

- 5 The Bank Guarantee imposed in PA 224/14 to ensure that the street is properly restored in accordance with the Environmental Management Construction Site Regulations, 2007 (Legal Notice 295 of 2007) shall still apply. The bank guarantee shall only be released after the permit submits a post-construction condition report together with photographs evidencing compliance with this condition, accompanied by clearance from the Local Council. The clearance from the Local Council is to be endorsed by the Mayor and the Executive Secretary of the Local Council. This guarantee shall be forfeited if, after 3 months from the date of notification by the Authority of a notice to effect the remedial works, these are not carried out. Its forfeiture shall not, however, preclude the applicant from adhering to all the conditions contained in this development permission.

6 **Conditions imposed and enforced by other entities**

A. Where construction activity is involved:

(a) the applicant shall:

(i) **Appoint a Project Supervisor for the Design Stage and a Project Supervisor for the Construction Stage** and any such appointment shall be terminated, changed or renewed as necessary. The same person may be appointed to act as project supervisor for both the design and construction stage, if that person is competent to undertake the duties involved and

(ii) **Keep a health and safety file** prepared by the Project Supervisor for the Design Stage.

(b) When the construction works related to this application are scheduled to last longer than thirty working days and on which more than twenty workers are occupied simultaneously, or on which the volume of work is scheduled to exceed five hundred person-days, the project supervisor **shall communicate a prior notice to the Occupational Health and Safety Authority (OHSA) at least four calendar weeks before commencement of works.**

(c) The Project Supervisor for the Design Stage shall **draw up a health and safety plan** which sets out the occupational health and safety rules applicable to the construction

activities concerned, outlining the measures to ensure cooperation between different contractors and shall also include specific measures concerning occupational risks that may be present at this site.

B. Where the development concerns a change of use to a place of work, the applicant shall obtain a Perit's declaration that the building conforms to the requirements of LN 44 of 2002.

C. Where the development concerns a place of work:

The applicant shall:

(i) obtain a Perit's declaration that the necessary requirements arising out of LN 44 of 2002 have been included in the plans and drawings; and

(ii) obtain a Perit's declaration that the building conforms to the requirements of LN 44 of 2002.

D. The development is to strictly adhere to the 'Design Guidelines on fire safety for buildings in Malta' to ensure that all Fire Safety measures and provisions are addressed as indicated in the Design Guidelines on Fire Safety for Buildings in Malta, published by the DCID in 2004, (or other relevant standard, provided it is approved by the Civil Protection Department), Policies, and the Laws and Regulations of Malta.

E. Where the development includes a livestock farm:

(a) The farm **shall not** be connected directly to the sewer network.

(b) Silting traps, sedimentation pits as well as manure clamps shall be installed, as shown on the approved drawings. Settled Waste water shall only be discharged in approved waste receiving stations.

(c) Any effluents discharged shall have chloride levels lower than 1000 mg/L. The operators shall acquire a Public Sewer Discharge Permit before commencing operations.

F. Where the development includes a swimming pool:

(a) Any effluent, if discharged in the sewers, shall meet the specifications listed in L.N.139 of 2002 as amended by L.N.378 of 2005.

(b) Adequate sampling points should be installed as directed by WSC – Discharge Permit Unit officials.

(c) Chlorine concentration of the effluent should not exceed 100 mg/L Cl₂.

G. Prior to laying of water and wastewater services in the road, the development shall comply with the requirements of Legal Notice 29/10 Part III (Roads in inhabited Areas) Clause 12.

H. In the event of an accidental discovery in the course of approved works, any cultural heritage feature discovered should not be damaged or disturbed and the Superintendence is to be immediately informed of such discovery. Any cultural heritage features discovered are to be investigated, evaluated and protected in line with the Cultural Heritage Act 2002 (CAP 445). The discovery of cultural heritage features may require the amendment of approved plans.

In terms of Article 72(3) of the Development Planning Act, 2016, the execution and validity of this permission is automatically temporarily **suspended** and no works as approved by the said development permission may commence before the lapse of the time period established in Article 13 of the Environment and Planning Review Tribunal Act and subsequently will remain so suspended if the Tribunal so decides in accordance with the Environment and Planning Review Tribunal Act.

Where the approved drawings and/or documents are dimensioned, then the declared dimensions shall prevail over the actual size as depicted on the approved drawings and/or documents.

Developers are advised to check the invert level to the sewer main with the Water Services Corporation as they would have to make their own arrangements where a gravity service connection is not possible. In these cases, the architect has to indicate the solutions envisaged and to indicate on the plan what needs to be carried out and obtain approval from WSC. Developers are further reminded that connection of storm water into main sewers is not allowed.

If the declaration of ownership, as contained in the application form, is determined as incorrect by a Court of Law, then the said Court of Law can declare this development permission as null and void. This development permission does not remove or replace the need to obtain the consent of the land/building owner to this development before it is carried out. Furthermore, it does not imply that consent will necessarily be forthcoming nor does it bind the land/building owner to agree to this development. Where the land/building is owned or administered by the Government of Malta a specific clearance and agreement must be obtained for this development from the Land and/or Estate Management Departments.

This development permission is granted saving third party rights. This permission does not exonerate the applicant from obtaining any other necessary permission, license, clearance or approval required from any Government department, local council, agency or authority, as required by any law or regulation.

This development permit does not authorise any storage of substances listed in Occupational Health and Safety Authority Act (Cap. 424) - Control of Major Accident Hazards Regulations, 2003, as amended, in quantities that would render this site an establishment within scope of these regulations. The storage and handling of said substances may require a new or amended development permission in line with current policies and regulations.

For any non-residential uses hereby being approved, prior to commencement of any works on site or any eventual permitted change of use, the applicant shall be required to contact the Environment and Resources Authority to obtain any necessary operational permit or registration. This requirement does not apply to Class 2B, 2C, 4A and 4B uses as listed in the Development Planning (Use Classes) Order 2014, or its subsequent amendments.

This decision is being published on 14 June 2017.

Marthese Debono
Secretary Planning Commission (Development Permissions)

Notes to Applicant and Perit

Right for reconsideration

Where applicable, you have a right to submit a request for reconsideration to the Authority in terms of regulation 14 of Legal Notice 162 of 2016.

Right for appeal

You have a right to submit an appeal, against the decision, to the Environment and Planning Review Tribunal in terms of Article 13 of the Environment and Planning Review Tribunal Act, 2016.

Time limits

Requests for reconsideration or appeals must be made within 30 days from the publication of the decision notification in the local press as required by regulation 14(1) of Legal Notice 162 of 2016.

Fees to submit a request for reconsideration or appeal

In either case, there is a fee to be paid which should accompany the request for reconsideration or the appeal. The fees are as follows:

For reconsideration - 3% of the Development Permit Fee paid in respect of the original application, subject to a minimum of €69.88.

For appeal - 5% of DPF (Development Permit Fee) paid in respect of the original application, subject to a minimum of €150 + €50 administrative fee (LN 112 of 2016).

Submission of request for reconsideration or appeal

With regards to requests for reconsideration, Form PA 4/16 must be used for submission. All fields of the Form must be filled in as appropriate. Requests for reconsideration can only be submitted electronically.

With regards to appeals, as required by Article 13 of the Environment and Planning Review Tribunal Act, 2016, the submission must include the detailed grounds for appeal and the requests being made by the appellant. Appeals must be submitted physically at the offices of the Environment and Planning Review Tribunal, St. Francis Ditch, Floriana.

Important Notice

In view of the provisions of Article 72(4) of the Development Planning Act (2016), a Commencement Notice is to be submitted to the Planning Authority, by the perit on behalf of the applicant, at least FIVE DAYS prior to the date of commencement of works or utilisation of the permission. Failure to submit the Commencement Notice (with all fields correctly completed) or failure to submit it within the required timeframe shall invalidate the Notice and shall result in the imposition of fines according to Schedule D of Legal Notice 277 of 2012, or its amendments, or its replacements. In addition, if the applicant fails to submit the Commencement Notice or the Commencement Notice submitted is invalid, the relative permission shall be considered as never having been utilised.

-PADCN-

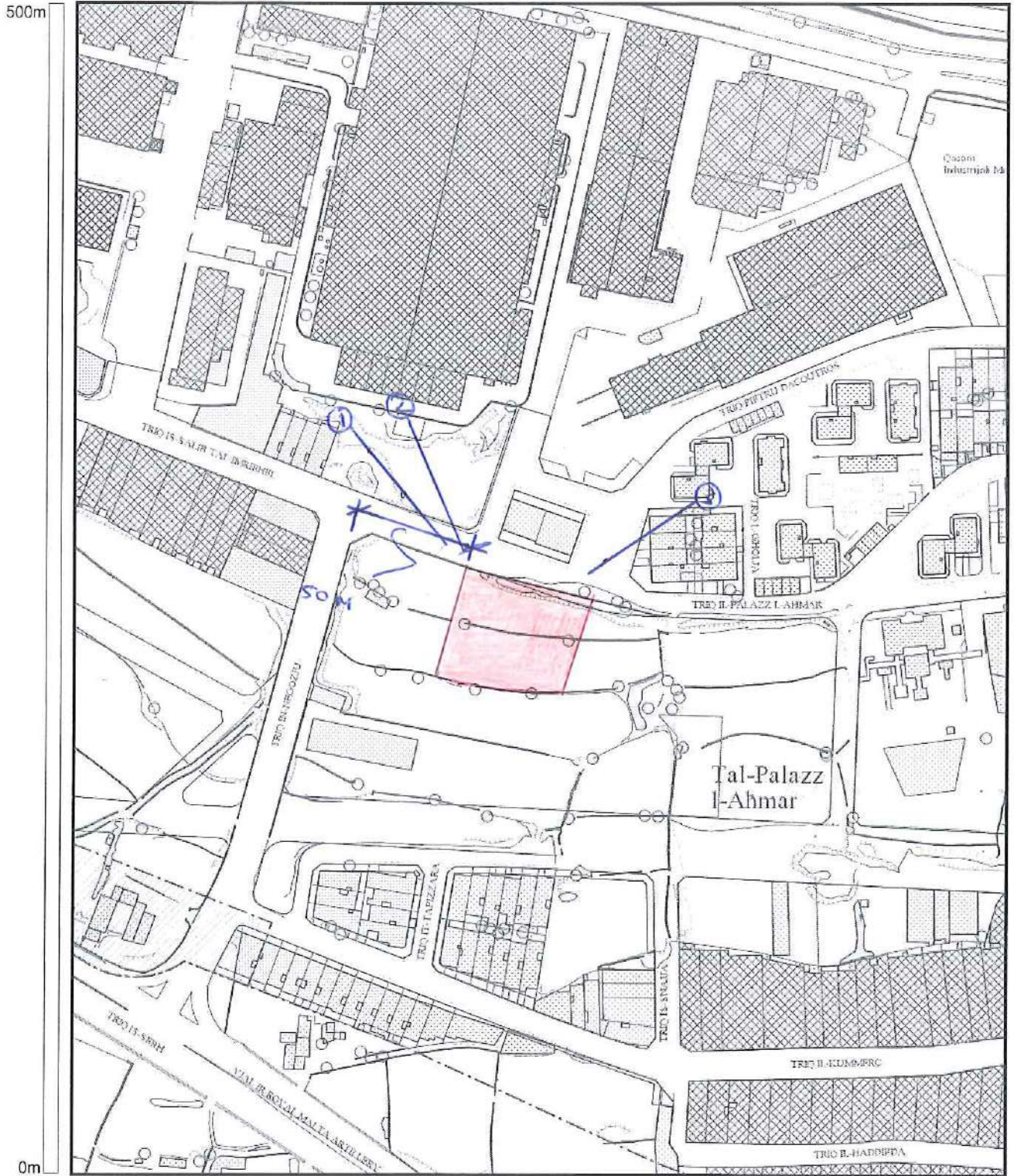

Min Easting 52019.49, Min Northing 71598.1, Max Easting 52419.49, Max Northing 72098.1



Planning Authority - www.pa.org.mt

St. Francis Ravelin
Floriana FRN 1230, Malta
PO Box 200, Marsa MRS 1000, Malta
Tel: +356 2290 0000 Fax: +356 22902295

Site Plan, Scale 1:2500
Printed on: Wednesday, December 07, 2016

Not to be used for interpretation or scaling of scheme alignments
Copyright © PA - Planning Authority. Not for resale.

Perit Ivan A. Bondin
B.E.&A.(Hons.), M.Sc.(Ed.), A.&C.E.
38, Triq ix- Xibet, Mgabba, MQB 1320
Tel: 2168 3147 - Mob: 9989 4078
Email: bondin@convel.net

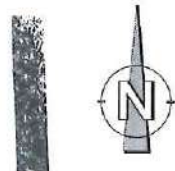

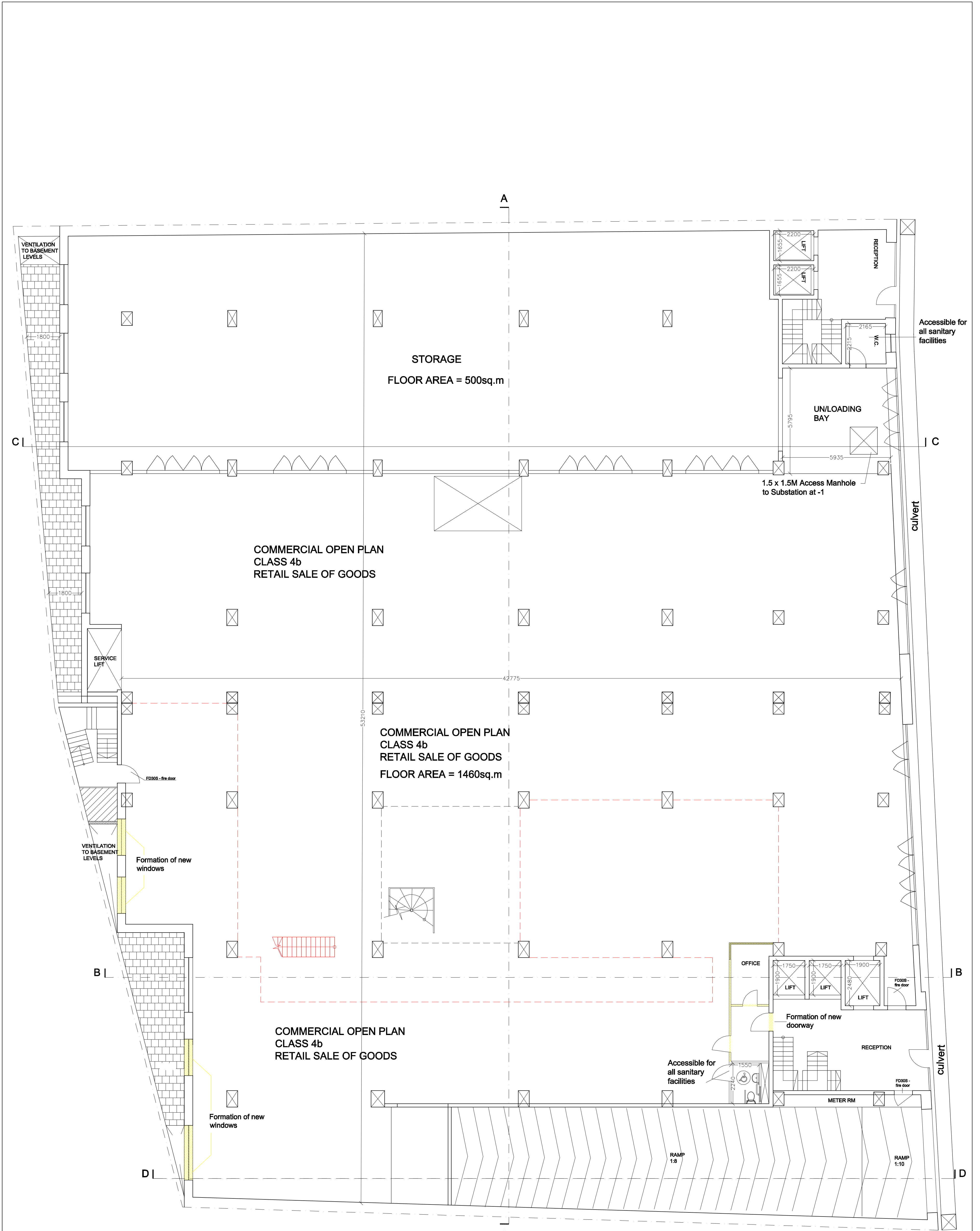

1 PROPOSED VS APPROVED LEVEL 0
 SCALE 1:100

Legend
 To be removed
 As proposed

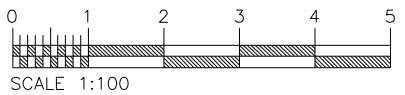

Perit Ivan A. Bondin
 B.E.&A. (Hons.), M.Sc. (Edin.), A.&C.E.
 La Pietà, 38, Triq ix-Xriek, Mgabba, MQB 1320.
 Tel: 21683147 Mob: 79594078 Mail: bondin@onvol.net

Job Description: Alterations and additions to PA 0224/14. Changes relate mainly to the extension of the Intermediate level for additional Category D Class AA facilities to be created
 Scale: As shown
 Drawing Nr: A001C
 Date: 27-03-17
 Title: Approved vs proposed ground floor plan
 Drawn by: IB

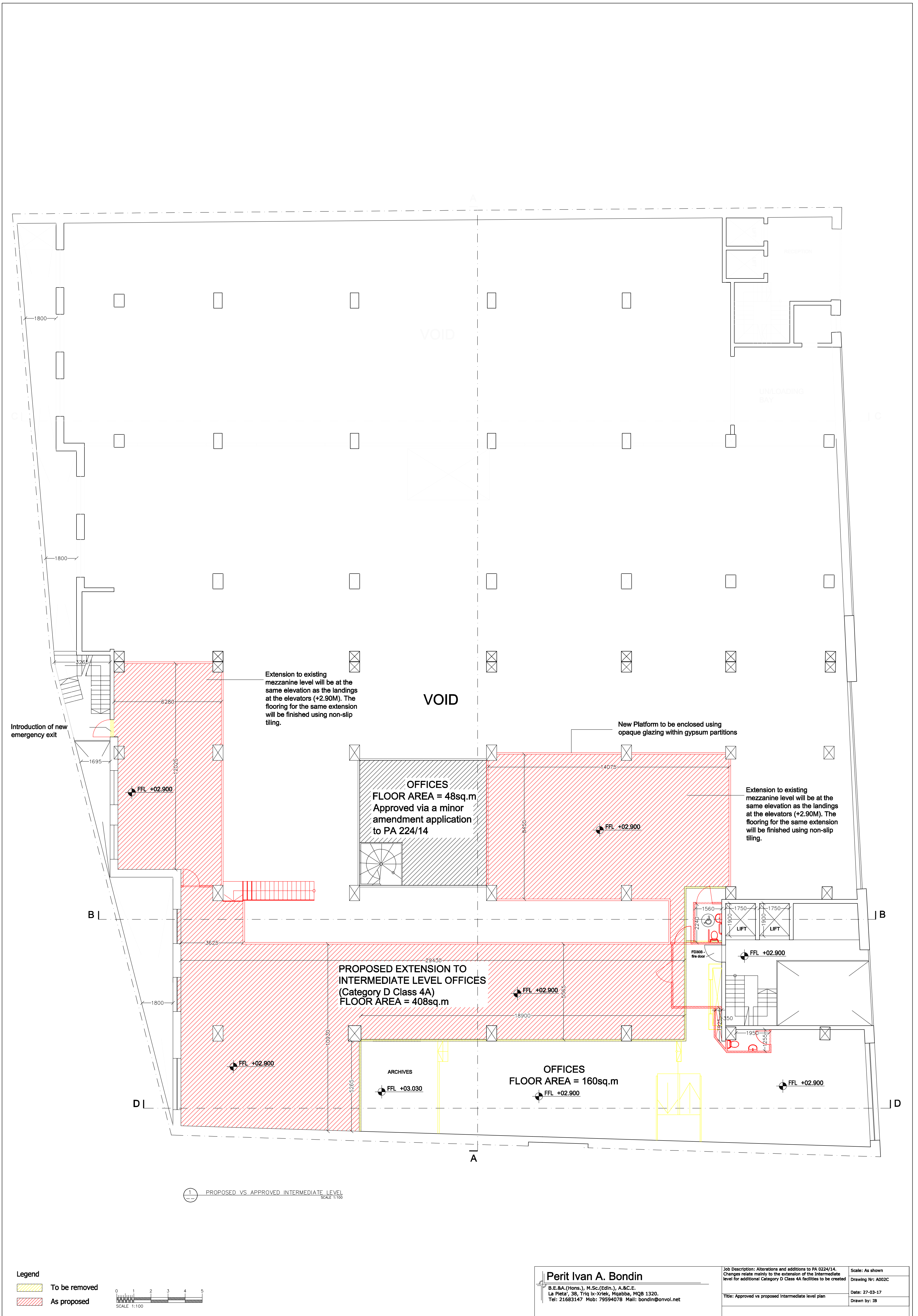

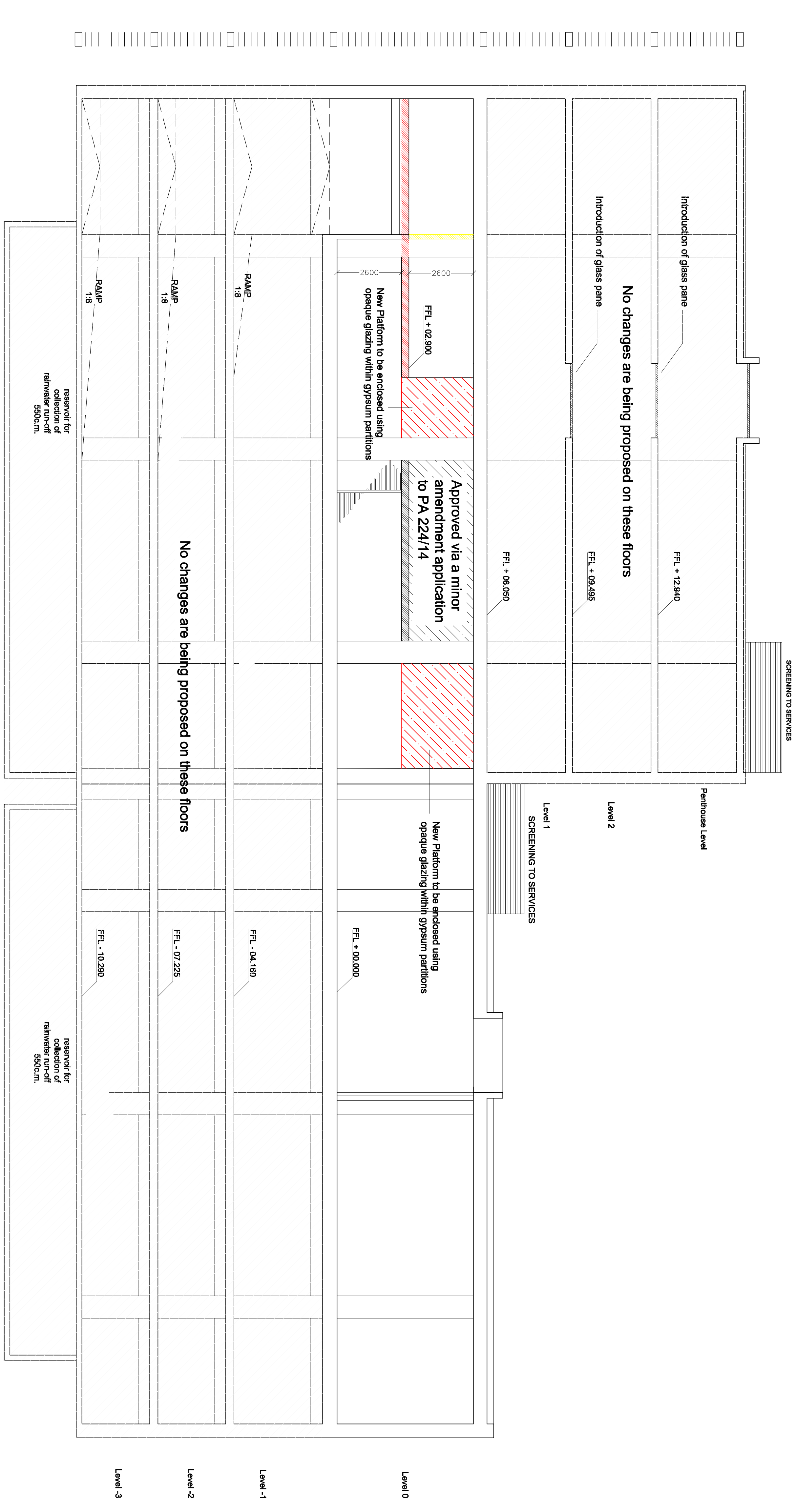

Perit Ivan A. Bondin
 B.E. (Arch), M.Sc. (Civil), A.A.C.E., Reg. 1320
 Tel: 21653147 Mob: 75594078 Mail: bondin@bondin.net

Job Description: Alterations and additions to PA 0224/14.
 Changes relate mainly to the extension of the Intermediate level for additional Category C Class 4k facilities to be created.
 Title: Approved vs proposed Section AA

Scale: As shown
 Drawing No: A020C
 Date: 27-03-17
 Drawn by: JB

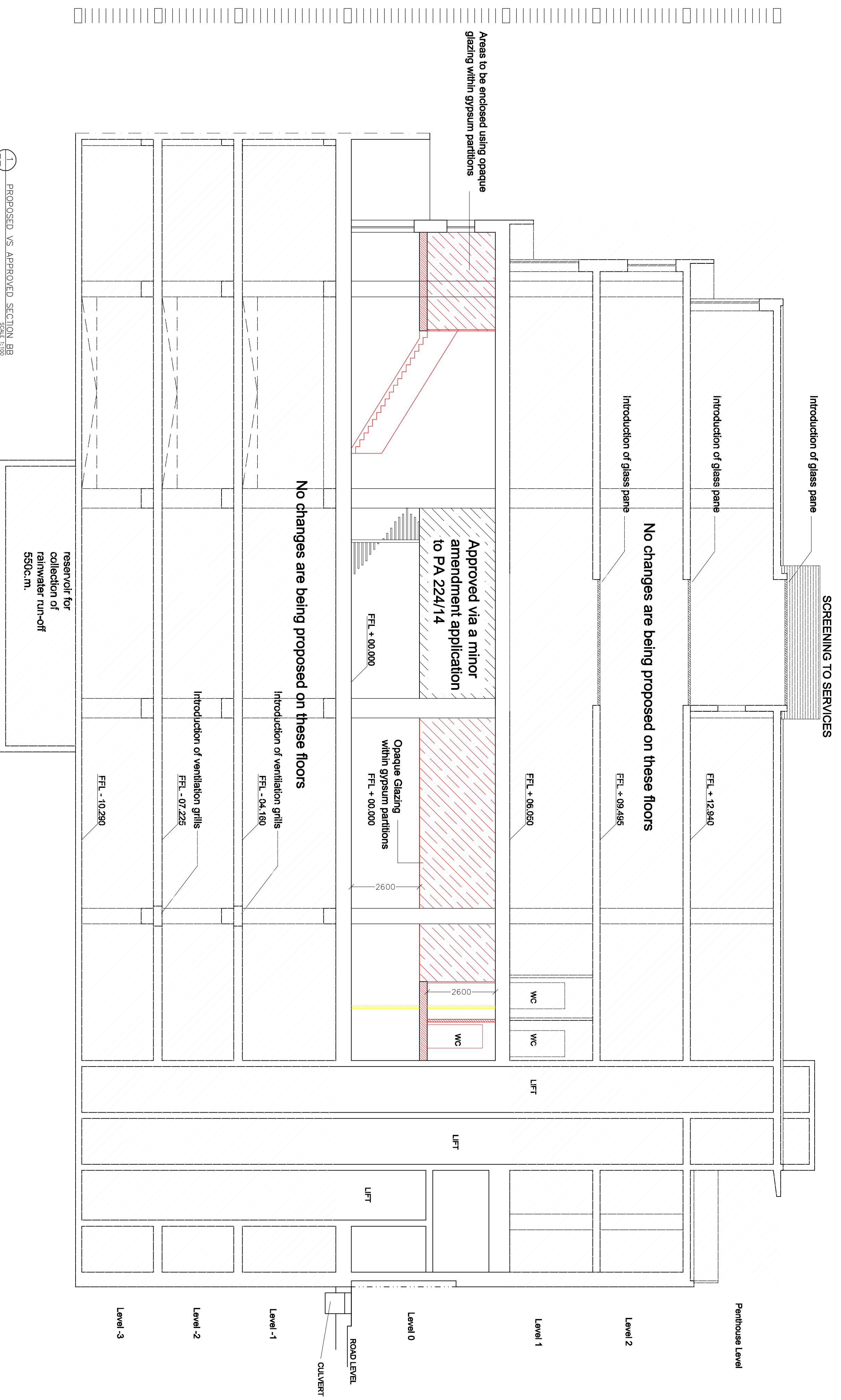

PROPOSED VS APPROVED SECTION BB SCALE 1:100

Legend

To be removed

AS proposed

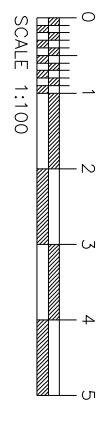

Perit Ivan A. Bondin
 R.E. 044 (1998), M.Sc. (2001), A.A.C. (1998), R.Q. 1320
 Tel: 21653147 Mob: 75594078 Mail: bondin@bondin.net

Job Description: Alterations and additions to PA 0224/14. Changes relate mainly to the extension of the Intermediate level to additional Category C Class 4k facilities to be created.

Title: Approved vs proposed drawings

Scale: As shown
 Drawing No: 4024C
 Date: 27-03-17
 Drawn by: JB

Legend

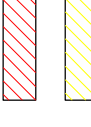
 To be removed

 AS proposed

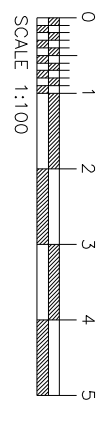

PROPOSED VS APPROVED SECTION DD
SCALE 1:100



Perit Ivan A. Bondin
 R.E. & A. (Perit I.A. Bondin), A.A.C. No. 1320
 Tel: 21653147 Mob: 79594078 Mail: bondin@bondin.net

Job Description: Alterations and additions to PA 0228/14.
 Changes relate mainly to the extension of the Intermediate level for additional Category C Class 4k facilities to be created.
 Title: Approved vs proposed drawings

Scale: As shown
 Drawing No: A055C
 Date: 27-03-17
 Drawn by: JB

Annex Nr 3 – Photographic Survey



Photo 1



Photo 2



Photo 3



Photo 4

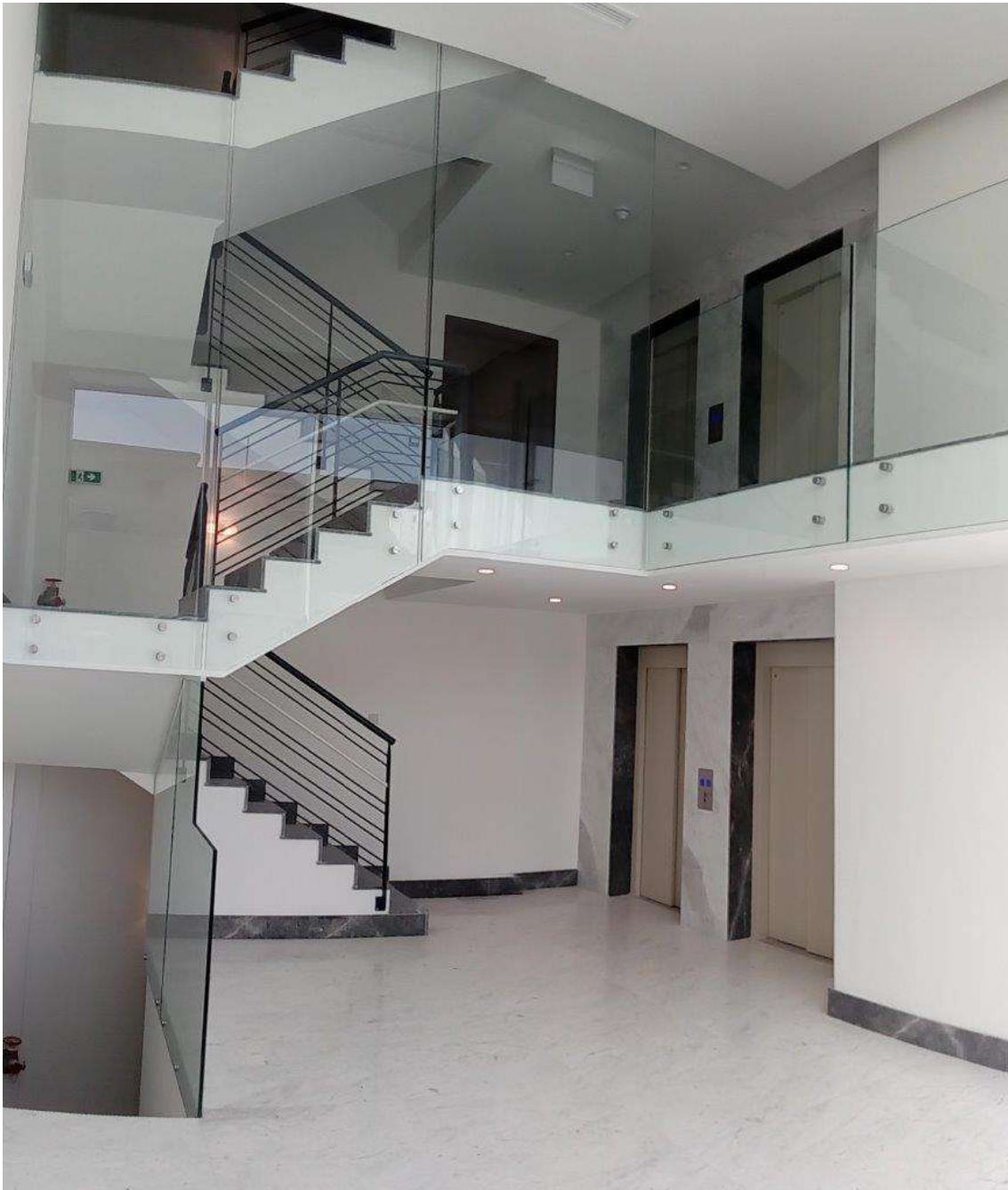

Photo 5



Photo 6

Annex Nr 4 – Hypothecs

8672

Note of registration of Hypothec & Privilege

Progressive Number

Remarks
(for official
use only)

Creditor: Bank of Valletta p.l.c. (C 2833).

Debtor: "K.A. Holdings Limited", with registration number letter "C" five six zero two three (C56023).

Credit: Two million and five hundred thousand Euro (Eur2,500,000), granted on loan by the Creditor unto the Debtor, hereinafter referred to as the "Loan" out of which Loan, the amount of one million one hundred and forty-nine thousand seven hundred and twenty Euro and seventy-eight Euro cent (Eur1,149,720.78c), the debtor as delegated by the debtor, paid it directly to Banif Bank, in the second part of the deed, in full and final settlement of the liabilities of the debtor with Banif Bank, and this in such a way as to enable the creditor to obtain in its favour any and all rights competent to it in terms of law by way of subrogation of rights as stipulated in the deed, whereas to the sum of one million fifty thousand two hundred and seventy-nine Euro and twenty-two Euro cent (Eur1,050,279.22c), is to be used by the debtor for its business commitments and which sum shall be withdrawable for the aforementioned purpose, in one amount or in several amounts at the Bank's sole discretion provided that the total amount withdrawn shall not exceed the sum of one million fifty thousand two hundred and seventy-nine Euro and twenty-two Euro cent (Eur1,050,279.22c) and whereas to the remaining sum of three hundred thousand Euro (Eur300,000) the debtor delegated the creditor which accepted, to pay it in its sole discretion directly to the architect, contractors, masons and other workmen and suppliers of materials to be involved in the development and/or improvements and/or alterations being and/or to be effected on the immovable property hereunder better described, in such a way as to enable the Bank to retain, reserve and conserve in its favour, as the case may be, the special privilege competent to it in terms of section two thousand and ten (2010), of the Civil Code, of the Laws of Malta and which sum may also be withdrawn in one amount or in several amounts, at the Bank's sole discretion, provided that the total sum of withdrawals shall not exceed the sum of three hundred thousand Euro (Eur300,000). The parties agreed that the Loan and the security thereof shall be regulated by such conditions, including repayments as have been and or shall be from time to time notified in writing by the Creditor and accepted by Debtor. The Loan shall bear interest at rate stipulated in the Sanction Letter. The said interest is to be reckoned on the outstanding balance of the Loan from time to time, in accordance with recognised banking practice, and under all the other terms and conditions stipulated in the deed in my records of the nineteenth (19th)

2766.05

AD
S

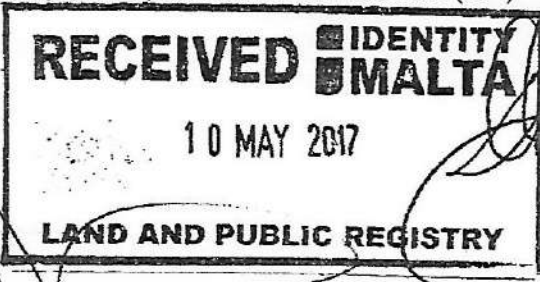

day of April of the year two thousand and seventeen (2017).

Cause of preference: **General Hypothec** for the sum of *two million and five hundred thousand Euro (Eur2,500,000)* and interests accruing thereon and charges in connection therewith, on all the property of the debtor in general present and future and a **Special Hypothec** for the sum of *two million and five hundred thousand Euro (Eur2,500,000)* and interest accruing thereon and charges in connection therewith over :

The divided portion of developable land, outlined in pink and marked with the letter "D" on the large scale plan attached to the deed of acquisition by the said debtor of the said land in my records, of the twenty-fifth (25th) day of May of the year two thousand and twelve (2012) and therein marked as document letter "G", measuring circa one thousand two hundred and ninety-one point seven square metres (1,291.7sq.m).

The said divided portion of land, is also outlined in pink on the site plan, attached to the aforementioned deed of acquisition in my records and therein marked as document letter "C".

As is bounded on the North with Triq il-Palazz l-Ahmar, where the said divided portion of land has its façade and from where it is directly accessible, on the West by another divided portion from the said field, known as "Tal-Palazz L-Ahmar" marked with the letter "C" on the aforementioned large scale plan marked as document letter "G" being property of the successors in title of Family Cassar and on the East by another divided portion from the said field, known as "Tal-Palazz l-Ahmar", marked with the letter "E" on the aforementioned large scale plan marked as document letter "G", also property of the successors in title of Family Cassar and on the South with fields belonging to third parties or more accurate and precise boundaries.

Formerly forming part of a larger divided portion of the field known as "Tal-Palazz l-Ahmar", in Qormi, limits of Santa Venera, with direct access from Triq il-Palazz l-Ahmar.

The said divided portion of land is being hypothecated as free and unencumbered, with all its rights and appurtenances, including any and all improvements effected thereto and/or in lieu thereof, and a **Special Privilege** for the sum of *three hundred thousand Euro (Eur300,000)* and interests accruing thereon and charges in connection therewith over the same said property above described.

Tollay
Director



021688

Nota ta' iskrizzjoni ta' Ipoteka

Numru Progressiv

Rimarki

(ghal uzu ufficjali)

Kreditur: **Bank of Valletta p.l.c.** (C2833).

Debituri: **"Project Technik Building Supplies Limited"**, bin-numru ta' registrazzjoni ittra "C" numri; hamsa sitta tlieta tmienja tlieta (C 56383); bhala d-debitrici principali; **"K.A. Holdings Limited"**, bin-numru ta' registrazzjoni ittra "C" numri; hamsa sitta zero tnejn tlieta (C 56023) flimkien bhala garanti, flimkien u in solidum mad-debitrici principali.

Kreditu: Is-somma ta' seba' u ghoxrin elf u disa' mitt Ewro (€27,900) hawn aktar 'il quddiem imsejha "is-self", mislufa mill-Kreditur versu u a favur tad-Debitrici principali b'att tieghi tal-hdax (11) t' Ottubru tas-sena elfejn u sbatax (2017) u liema somma d-debitrici ghandha bzonnha ghal bzonnijiet kummercjali taghha u liema somma tista' tingibed f'ammont wiehed jew f'diversi ammonti basta l-gbid totali ma jeccediex is-somma ta' sebgħa u ghoxrin elf u disa' mitt Ewro (€ 27,900). Gie miftiehem illi fuq is-somma mislufa ghandhom jiddekorru l-imghaxijiet bir-rata kif stipulata fl-ittra sanzjonarja; dawn l-imghaxijiet ghandhom jigu ikkalkolati fuq l-ammont dovut bhala bilanc ta' self mid-Debitrici principali, minn zmien għal zmien skond il-prattika bankarja u taht il-pattijiet u kundizzjonijiet kollha l-ohra stipulati fl-att.

Kawza ta' preferenza: Ipoteka Generali fuq il-gid kollu in generali, presenti u futuri tad-debitrici principali u tal-garanti, u dana għal ammont ta' seba' u ghoxrin elf u disa' mitt Ewro (€27,900), u imghax u spejjez ancillari, u Ipoteka Specjali għal ammont ta' seba' u ghoxrin elf u disa' mitt Ewro €27,900, imghax u hlasijiet/spejjez relattivi fuq il-fond urban ossia;

L-porzjoni diviza ta' art fabbrikabbi, inkluz kwalunkwe benefikati magħmlula fuqha u/jew li għadt jridu jigu mibnija fuqha u/jew minflokha, delineata bir-roza u mmarkata bl-ittra "D" fuq il-*"large scale plan"* annessa ma' l-att ta' l-akkwist tagħha fl-atti tieghi tal-hamsa u ghoxrin (25) gurnata ta' Mejju tas-sena elfejn u tnax (2012), hemm mmarkata bhala dokument ittra "G", li tikkonsisti f'parti diviza mill-għalqa magħrufa bhala "Tal-Palazz l-Ahmar", gewwa Hal-Qormi, limiti ta' Santa Venera, drabi ohra indikata bhala limiti ta' Birkirkara, b'access dirett minn Triq il-Palazz l-Ahmar. Tal-kejl din il-porzjoni diviza ta' art, ta' cirka elf mitejn wiehed u disghin punt sebgħa metru kwadru (1,291.7m.k).

Din il-porzjoni diviza ta' art, tinsab ukoll delineata bir-roza fuq is-*"site plan"* annessa ma' l-istess att fl-atti tieghi fuq citat u hemm mmarkata bhala dokument ittra "C".

16 NOV 2017



Konfinanti mit-tramuntana ma' Triq il-Palazz l-Ahmar, fejn ghandha l-faccata taghha din il-porzjoni diviza ta' art u minn fejn hija direttament accessibbli, mill-punent ma' porzjoni diviza ohra mill-istess ghalqa maghrufa bhala "Tal-Palazz L-Ahmar" mmarkata bl-ittra "C" fuq ic-citata pjanta dokument ittra "G", beni tas-successuri fit-titolu tal-familja Cassar, mill-lvant ma' porzjoni diviza ohra mill-istess ghalqa maghrufa bhala "Tal-Palazz l-Ahmar" mmarkata bl-ittra "E" fuq ic-citata pjanta dokument ittra "G", beni tal-familja Cassar, u minn nofs-in-nhar ma' raba ta' terzi jew irjeh iktar precizi u verjuri.

Kif intqal aktar il-fuq, din il-porzjoni diviza ta' art hija direttament accessibbli minn Triq il-Palazz L-Ahmar u tinsab f'Hal-Qormi, limiti ta' Santa Venera, u hija ezenti mill-hlas ta' kwalunkwe cens li jista jggrava l-imsemmija art jew xi parti minnha. Din l-art hija libera u franka, libera minn cnus u pizijiet u kif ukoll bhala hielsa minn kull servitu', kemm attivi u passivi, u tigi hawn ipotekata bid-drittijiet u l-pertinenzi kollha taghha, inkluz l-arja u s-sottosuol u kif ukoll kull u kwalunkwe ameljorament maghmul fuq u/jew minflok l-istess porzjon diviza ta' art.

Minn issa 'l-quddiem imsemmija 'l-Proprieta'.

Liema Proprieta' qeghdha tigi ipotekata bid-drittijiet, gustijiet u l-pertinenzi kollha taghha u inkluz kull u kwalunkwe benefikat u/jew ameljorament maghmul fuq u/jew minflok l-istess Proprieta' fuq deskritta. Din il-porzjon diviza ta' art hija proprieta' tal-garanti.

Ilum

16 NOV 2017

Direttur

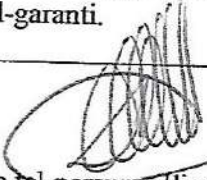
firma tal-persuna illi qed
tapplika ghall-iskrizzjoni

Notary Dr. Kristel E Chircop

Nota ta' iskrizzjoni ta' Ipoteka

Numru Progressiv

021695

Rimarki
(ghal uzu ufficjali)

Kreditur: Bank of Valletta p.l.c. (C2833).

€ 254,45

Debituri: "Project Technik Building Supplies Limited", bin-numru ta' registrazzjoni ittra "C" numri; hamsa sitta tlieta tmienja tlieta (C 56383); bhala d-debitrici principali; "K.A. Holdings Limited", bin-numru ta' registrazzjoni ittra "C" numri; hamsa sitta zero tnejn tlieta (C 56023) bhala garanti, flimkien u in solidum mad-debitrici principali.

Kreditu: Is-somma ta' mitejn u hamsin elf Ewro (€250,000) bhala *overdraft* u facilitajiet ohra bankarji inkluzi l-"general banking facilities", skond il-htiega tan-negozju tad-debitrici principali, suggett li l-ammont ta' debitu attwali jew kontingenti, tad-debitrici principali u l-Garanti favur il-kreditur emananti minn dan il-kuntratt qatt ma ghandu jeccedi s-somma ta' mitejn u hamsin elf Ewro (€250,000).

Gie miftiehem bejn il-partijiet illi l-indikazzjoni tas-somma ta' mitejn u hamsin elf Ewro (€250,000), bhala limitu ta' *overdraft* u facilitajiet l-ohra bankarji inkluzi l-"general banking facilities" fuq dan l-att, ma ghandu bl-ebda mod jigi interpretat bhala obligazzjoni minn-naha tal-kreditur, sabiex ihalli lid-debitrici principali teccedi l-kont taghha sa tali ammont, jew ta' xi kwalunkwe dritt minn-naha tad-debitur principali ghall-facilitajiet bankarji inkluzi "general banking facilities" sa dak l-ammont; b'dana illi l-ammont totali tad-dejn, attwali u/jew kontingenti, tad-debitur principali favur il-Bank, rizultanti minn dan l-att, hu u ghandu ikun f'kull hin, fid-diskrezzjoni assoluta tal-Bank.

Il-kreditur, id-debitur principali u l-Garanti ftehm u li l-imghax bir-rata stipulata fis-"*sanction letter*" jiddekorri fuq l-*overdraft* u huma dovuti mid-debitur principali u/jew il-Garanti minn jum ghal jum u dan l-imghax jigi kkalkulat fuq 'daily debit balances' skond il-prattika bankarja rikonuxxuta u taht il-pattijiet u kundizzjonijiet kollha l-ohra stipulati fl-att. ~~magħmul fil-haxx 11~~ t' Ottubru elfejn u sbatax (2017)

Kawza ta' preferenza: Ipoteka Generali fuq il-gid kollu in generali, presenti u futuri *tad-debitrici principali u tal-garanti*, u dana ghal ammont ta' mitejn u hamsin elf Ewro (€250,000), u u imghax u spejjez ancillari, u Ipoteka Specjali ghal ammont ta' mitejn u hamsin elf Ewro (€250,000), imghax u hlasijiet/spejjez relattivi fuq il-fond urban ossia;

L-porzjoni diviza ta' art fabbrikabbli, inkluz kull u kwalunkwe benefikati maghmlula fuqha u/jew minflok l-istess porzjon art, delineata bir-roza u mmarkata bl-ittra "D" fuq il-"*large scale plan*" annessa ma' l-att ta' l-

16 NOV 2017

akkwist taghha fl-atti tieghi tal-hamsa u ghoxrin (25) gumata ta' Mejju tas-sena kurrenti elfejn u tnax (2012), hemm mmarkata bhala dokument ittra "G", li tikkonsisti f'parti diviza mill-ghalqa maghrufa bhala "Tal-Palazz l-Ahmar", gewwa Hal-Qormi, limiti ta' Santa Venera, darbi indikata bhala limiti ta' Birkirkara, b'access dirett minn Triq il-Palazz l-Ahmar. Tal-kejl din il-porzjoni diviza ta' art, ta' cirka elf mitejn wiehed u disghin punt sebgha metru kwadru (1,291.7m.k).

Din il-porzjoni diviza ta' art, tinşab ukoll delineata bir-roza fuq is-"site plan" annessa ma' l-istess att fl-atti tieghi fuq citat u hemm mmarkata bhala dokument ittra "C".

Konfinanti mit-tramuntana ma' Triq il-Palazz l-Ahmar, fejn ghandha l-faccata taghha din il-porzjoni diviza ta' art u minn fejn hija direttament accessibbli, mill-punent ma' porzjoni diviza ohra mill-istess ghalqa maghrufa bhala "Tal-Palazz L-Ahmar" mmarkata bl-ittra "C" fuq ic-citata pjanta dokument ittra "G", beni tas-successuri fit-titolu tal-familja Cassar, mill-lvant ma' porzjoni diviza ohra mill-istess ghalqa maghrufa bhala "Tal-Palazz l-Ahmar" mmarkata bl-ittra "E" fuq ic-citata pjanta dokument ittra "G", beni tal-familja Cassar, u minn nofs-in-nhar ma' raba ta' terzi jew irjeh verjuri u iktar precizi.

Kif intqal aktar il-fuq, din il-porzjoni diviza ta' art hija direttament accessibbli minn Triq il-Palazz L-Ahmar u tinsab f'Hal-Qormi, limiti ta' Santa Venera, drabi ohra indikata bhala limiti ta' Birkirkara u hija ezenti mill-hlas ta' kull u kwalunkwe cens li jista jggrava l-imsemmijha art jew xi parti minnha. Din l-art hija libera u franka, libera minn cnus u pizizjiet u kif ukoll bhala hielsa minn kull servitu', kemm attivi u passivi, bid-drittijiet u l-pertinenzi kollha taghha, inkluz l-arja u s-sottosuol u kif ukoll kull u kwalunkwe benefikati maghmula minflok l-istess porzjon art. Minn issa 'l-quddiem imsemmija 'l-Propjeta'.

Il-Propjeta' giet ipotekata bid-drittijiet, gustijiet u l-pertinenzi kollha taghha u inkluz kull u kwalunkwe benefikat u/jew ameljorament maghmul fuq u/jew minflok l-istess Propjeta' fuq deskritta.

Din il-porzjon diviza ta' art hija proprjeta' tal-garanti.

Illum

16 NOV 2017

Direttur

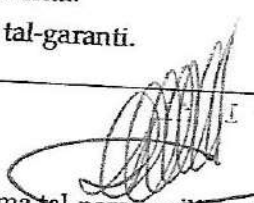
firma tal-persuna illi qed
tapplika ghall-iskrizzjoni

Notary Dr. Kristel E Chircop

Att: Mr Kurt Abela

June 17th 2019

KA Holdings Ltd

Project Technik,

Canon Road,

Qormi, QRM 9032

RE: Valuation of a plot of land located in Triq il-Palazz I-Aħmar, Mrieħel, Birkirkara

Introduction

I, the undersigned Architect & Civil Engineer, have been instructed by Mr Kurt Abela (ID: 0428881M), in his capacity as managing director of KA Holdings Ltd., to prepare a valuation report of a plot of land located in Triq il-Palazz I-Aħmar, Mrieħel, Birkirkara. The valuation report is being prepared in connection with the prospective bond issue, to be issued by KA Finance plc, for which an application will be made for the bonds to be admitted on Prospects MTF, the market regulated as a multilateral trading facility operated by the Malta Stock Exchange.

Basis of Valuation

This valuation report is being prepared in accordance with Chapter 4 of the Prospects MTF Rules (clause 4.13.00). It must be confirmed at the outset that this valuation report is being prepared independently and in line with the standards and guidelines of the UK Royal Institute of Chartered Surveyors. There is no conflict of interest in the advice given in this report apart from the fee associated with the preparation of the same report. The valuation is based on the direct knowledge of the site, the Maltese construction and property markets, the area within which this property is located as well as other information provided to me by KA Holdings and their professional advisers. For the purpose of this report, the market value is defined as the monetary amount a property is expected to realise when the same property is offered for sale in an open market, for a reasonable period of time, by a willing seller, in order to enable the property to be brought to the attention of potential and willing buyers and when the transaction is not affected by any special circumstance that might affect the buyer, the seller, or the property. The market value is based on the assumption that the buyer and the seller are both acting in their own best interests, have entered into the transaction without any element of compulsion or duress, and the buyer does not have any special relationship or obligation to the seller. Factors that affect the establishment of a market value for a

given property include the condition of the property, the interest held, the nature and conditions prevalent in the market at the date of the valuation, the location, permissible use, size and age.

Site visit and data consulted

The property has been visited on December 12th 2018 in connection with this valuation. For this inspection, I was accompanied by Mr Joseph Caruana Dingli, in his capacity as a representative of KA Holdings Ltd. In addition to the inspection of the property, the following documentation has also been referred throughout the preparation of this report;

- Site Plan
- Mrieħel Industrial Area Policy Map (see copy of policy map in Appendix Nr 1)
- Plans (kindly refer to Appendix Nr 2)
- Planning Authority Development Permits related to the same plot of land (kindly refer to Appendix Nr 3)
- Websites of local real estate agencies

The Property

The property in question is located in Triq il-Palazz I-Aħmar in Mrieħel, in close proximity to the commercial premises of other reputable local businesses such as JCR Ltd and Engel and Volkers Malta. Below is an aerial photo of the area within which this building is located. The property in question is marked in red.



Figure 1 –Aerial Photo – Property in question is marked in red

The plot in question has a square area of circa 1292.0 square metres and a frontage of circa 26.7 linear metres. Currently, the site is not developed (see photos in Annex nr 3), however, excavation works to allow for subsequent construction works were carried out at the time of writing of this report. The site in question is accessed from Triq il-Palazz I-Aħmar in Mrieħel that is in turn easily accessible from Mrieħel by-pass via Commerce Street. It is also important to point out that the site forming subject of this valuation report is adjacent to Centris 1, the commercial block that has already been developed and is also occupied. It is of relevance to state that Centris 1 is also a property that belongs to KA Holdings (see separate valuation report for additional details on Centris 1). It is being envisaged, that the site forming subject of this valuation report, is to be developed into a similar commercial block as Centris 1. The block that is yet to be developed on the site in question will be called Centris 2. In fact, it is being envisaged that when the site in question is developed into Centris 2, vehicular access will be obtained through Centris 1. Both Centris 1 and Centris 2 can be considered as one whole facility, once Centris 2 is developed. For more details, the reader is kindly referred to the annexed drawings.

Planning Considerations

Given that the site is located within the Mrieħel Industrial Area, this development is subject to the policies and land uses established in the Mrieħel Industrial Area Policy Map BKM2 of the Central Malta Local Plan. At the time of writing of this report, a development permit, PA 04584/17 was in hand. This permit consists of changes to the approved drawings of a previously issued permit (PA 0224/14, referred to in the valuation report for Centris 1) This development permit caters for the development of this site into the facilities listed below;

- a. Level -4: 28 open plan parking spaces
- b. Level -3: 33 open plan parking spaces
- c. Level -2: 40 open plan parking spaces
- d. Level -1: 39 open plan parking spaces
- e. Level 0: circa 1039.0 square metres of open plan office space (class 4A) & and a reception area
- f. Intermediate level: circa 1145.0 square metres of open plan office space (class 4A)
- g. First Floor level: circa 1173.0 square metres of open plan office space (class 4A)
- h. Second floor level: circa 1173.0 square metres of open plan office space (class 4A)
- i. Third floor level (receded floor level): circa 1025 square metres of open plan office space

The permit document as well as the permit drawings are being annexed to this report for ease of reference (Annex nr 3). Works on the construction of the above mentioned facility have been initiated and these works are expected to be completed by the end of June 2020, immediately after which, the facility can be occupied. It must be pointed out that at the time of writing of this report, there were no enforcement actions on the property in question. Nor were there any material contraventions.

Tenure

The property in question is freehold.

Details of registered mortgages, privileges and other charges

Prospects MTF rule 4.13.04 states that a valuation report is to include details of registered mortgages and privileges as well as other charges. It is understood that mortgages associated with the acquisition of the site in question are place. Details of these mortgages are being provided by the financial advisors of my client in separate reports. Nonetheless, a tabulated summary is being provided below with details. Copies of the relevant documentation are being annexed at the back of this report.

HSBC Hypothecs

Centris II, Plot C, Triq il-Palazz L-Ahmar, Mriehel

| No | Ref | Bank | Debtor | Guarantor | Basis | Type | Amount | Type | Amount |
|----|------------|------|--------|-----------|-----------|------|-----------|------|-----------|
| | | | | | | | Eur | | Eur |
| 1 | 14886/2014 | HSBC | PTL | n/a | Loan | SH | 945,700 | SP | 821,000 |
| 2 | 14889/2014 | HSBC | PTL | n/a | Overdraft | SH | 481,000 | GH | 481,000 |
| 3 | 21572/2014 | HSBC | PTL | n/a | Overdraft | SH | 1,000,000 | GH | 1,000,000 |
| 4 | 21573/2014 | HSBC | PTL | n/a | Overdraft | SH | 140,000 | GH | 140,000 |
| | | | | | | | 2,566,700 | | |

Valuation

The valuation for the property was carried out using a combination of three different valuation techniques;

- a. **Rental Return** - Initially, the annual rental return of the asset when built up as per the annexed drawings was calculated. The office space, when combined with the parking spaces that will be available once the asset is built, is calculated at circa €785,000.00 per annum. This has been calculated using simple comparative methods. Data for comparisons to be drawn

was obtained through KA Holdings representatives since they already have signed up contracts for Centris 1.

- b. **Capitalisation** – The annual rental return was then capitalised at the rate of 5%. For capitalisation purposes, however, this annual return has being reduced to €700,000.00. In doing this, a contingency has being factored in. When this amount is capitalised at 5%, then the value of the built up asset will be of €14,000,000.00.
- c. **Residual Method** – Given that the site is yet to be developed, the current market value of the site in its current state has been reached using a Residual approach. Once the value of the built up asset has been reached as per the above calculation, expenses associated with the development of the site were factored in. These included construction works, finishing works, architectural fees and Planning Authority fees. The profit for which a potential developer would consider such a venture has also been factored. Once all of the works expenses, fees due, taxation and potential profits have been factored in, the value of the site in question has been established at €6,400,000.00. Nonetheless, given that circa €300,000.00 of excavation work has already been carried out, the value of the plot of land in question is being valued at €6,700,000.00.

It is therefore being concluded that the site forming subject of this valuation report, in its current state, and as free from any other burden or servitude, has a market value of €6,700,000.00 (Euro Six Million & Seven Hundred Thousand). A summary of the workings associated with this calculation is being provided in Annex Nr 4 of this valuation report.

As a final remark, it must be stated that valuations are not a prediction of price, nor a guarantee of value, and whilst my valuation is one which I consider both reasonable and defensible, different valuers may properly arrive at different opinions value. Moreover, the value of property is susceptible to changes in economic conditions and it may therefore change over relatively short periods of time.

Perit Ivan Bondin

B.E. & A. (Hons), M.Sc (Edin.), A & C.E.

Warrant

Nr.

561

Annex Nr 1 –Mrieħel Industrial Area Policy Map

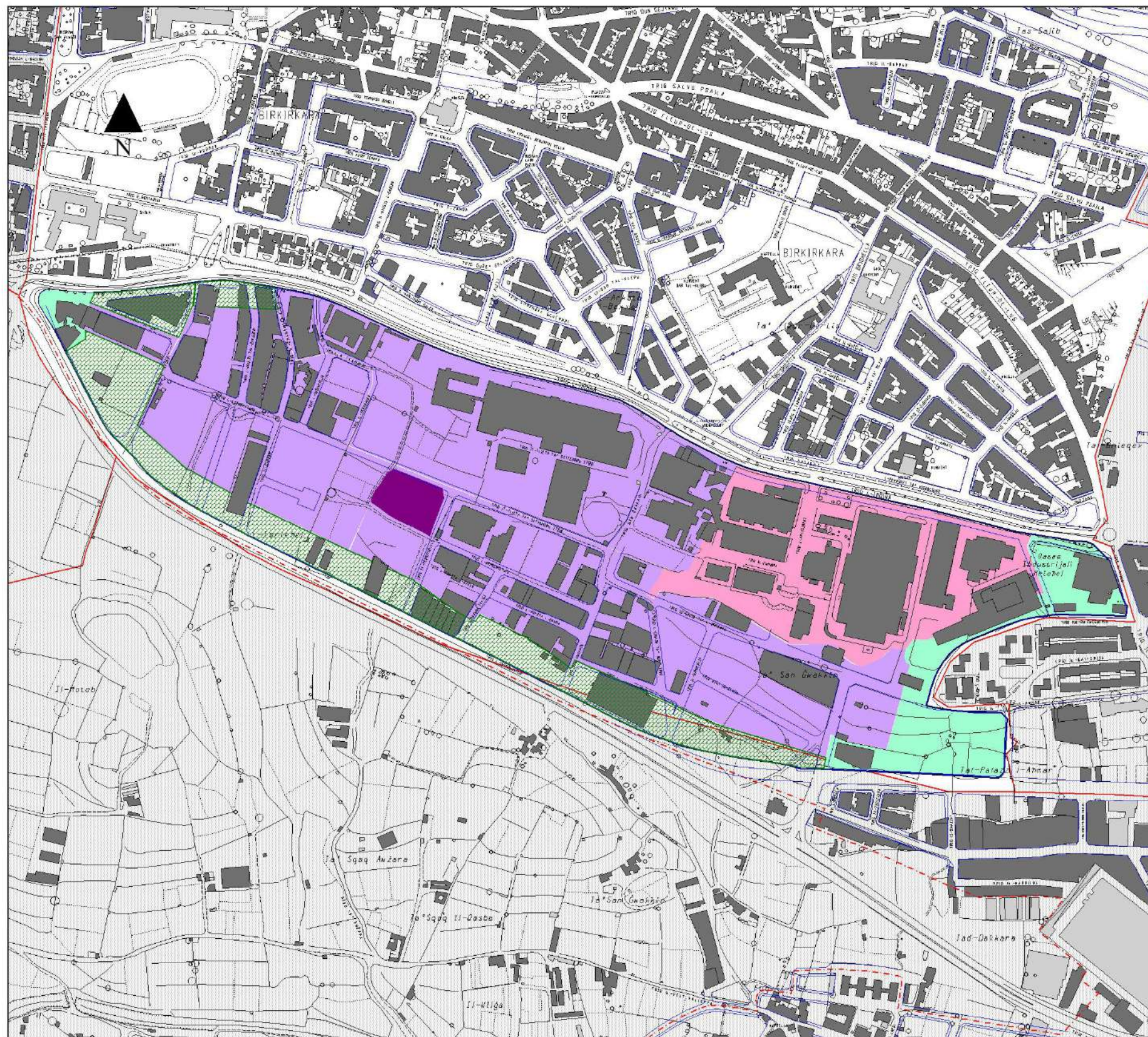

CENTRAL MALTA LOCAL PLAN



L-Awtorita' ta' Malta Dwar l-Ambjent u l-ippjanar
Malta Environment & Planning Authority

Key

- Local Council Boundary
- - - Limit to Development (TPS)
- Mriehel Industrial Area BK04
- MIP Estate
- SME Park
- Commercial Area CG14
- Offices
- Public Utility: Waste Management Civic Amenity Site and Electricity Substation

Mriehel Industrial Area
Area Policy Map

| | | |
|--|------------------|-------------|
| Scale : | Date : | Map : |
| 1:5000 | July 2006 | BKM2 |
| INDICATIVE ONLY Not to be used for direct interpretation or for the interpretation of street alignments. | | |
| Base Maps - 1988 Survey Sheets Copyright Mapping Unit, Malta Environment & Planning Authority | | |

3inset10

Annex Nr 2 – Photographic Survey

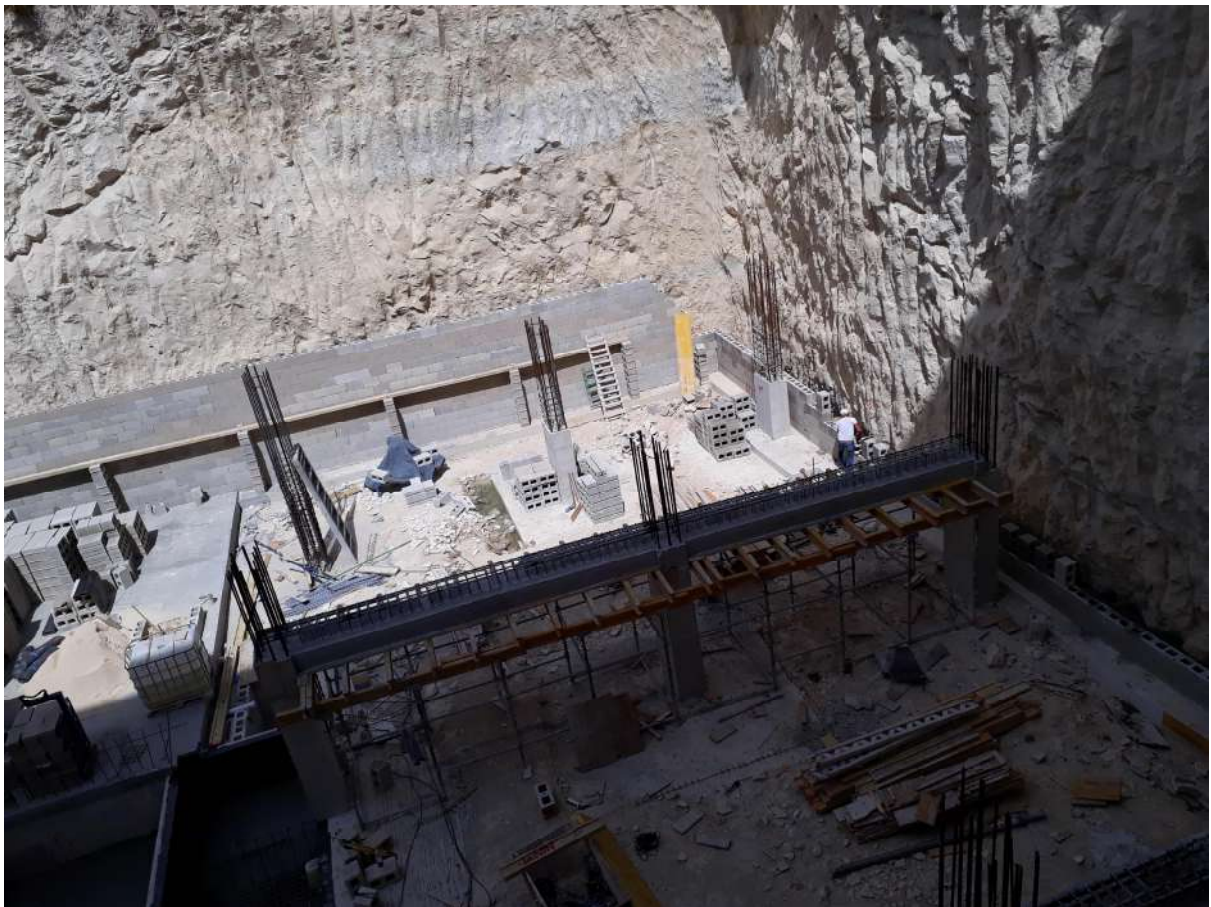



Annex Nr 3 – Permit Document and Drawings – PA 04584 / 17

Mr. Kurt Abela

Date: 21 March 2019
Our Ref: PA/04584/17

Application Number: PA/04584/17
Application Type: Full development permission
Date Received: 27 February 2017
Approved Documents: PA 4584/17/1A - Site Plan
PA 4584/17/23L - Section BB
PA 4584/17/23N - Section DD
PA 4584/17/27M - Elevation
PA 4584/17/97A - Roof Level
PA 4584/17/97B - Receded Floor Level
PA 4584/17/97C - Level 2
PA 4584/17/97D - Level 1
PA 4584/17/97E - Intermediate Level
PA 4584/17/97F - Level 0
PA 4584/17/97G - Level -1
PA 4584/17/97H - Level -2
PA 4584/17/97I - Level -3
PA 4584/17/97J - Section AA
PA 4584/17/97K - Section CC
PA 4584/17/97L - Level -4; and supporting documents

PA 4584/17/39A - Construction Management Plan
PA 4584/17/151A - Transport Malta
PA 4584/17/104A - Engineer's Report & Plans

Location: Centris, Triq Il-Palazz I-Ahmar, Birkirkara, Malta
Proposal: Amended application to PA 224/14. Works relate to the introduction of an additional basement parking level, internal and external alterations, change of use for part of ground floor level from commercial class 4B use (retail premises) to class 4A (offices), an additional part change of use from commercial class 4B use (retail premises) to class 4C (ancillary cafeteria) and the construction of three additional full floors and one receded floor.

Development Planning Act, 2016 Full Development Permission

The Planning Authority hereby grants development permission in accordance with the application and documents described above, subject to the following conditions:

- 1 The Bank Guarantee to the value of **EUR 2,166.44** issued in PA 224/14 shall be
- PA/04584/17 Print Date: 30/03/2019

transferred to cover this development permission, so as to ensure that the street is properly restored in accordance with the Environmental Management Construction Site Regulations, 2007 - Legal Notice 295 of 2007 (as amended). The bank guarantee shall only be released after the perit submits a post-construction condition report together with photographs evidencing compliance with this condition, accompanied by clearance from the Local Council. The clearance from the Local Council is to be endorsed by the Mayor and the Executive Secretary of the Local Council. This guarantee shall be forfeited if, after 3 months from the date of notification by the Authority of a notice to effect the remedial works, these are not carried out. Its forfeiture shall not, however, preclude the applicant from adhering to all the conditions contained in this development permission.

- 2 The development hereby permitted shall be subject to Final Compliance (Completion) Certification, verifying that the development has been carried out in full accordance with the approved drawings, documents and conditions imposed in this development permission, except where such conditions are enforced by other entities. Prior to the issue of any compliance certificate on any part of this development, the applicant shall submit to the Planning Authority, in relation to that part of the building:
 - (i) certification from a qualified engineer confirming that the development fully satisfies the requirements specified in supporting document PA 4584/17/104A.
- 3 The conditions imposed and enforced by Transport Malta are at supporting document PA 4584/17/151A. The architect/applicant is required to contact Transport Malta, throughout the implementation of the development hereby approved, to ensure conformity with the imposed conditions. A copy of the relative correspondence issued by Transport Malta shall be submitted to the Planning Authority accordingly.
- 4
 - a) The approved premises shall be used as indicated on the approved drawings or as limited by any condition of this permission. If a change of use is permitted through the Development Planning (Use Classes) Order, 2014 (or its subsequent amendments), and it is not restricted by a condition of this permission, approval from the National Commission for Persons with Disability may still be required. Reference needs to be made to MEPA Circular 3/10 or its subsequent amendments.
 - b) Where provided, loading and unloading shall take place solely within the premises, and not from/on the public pavement or street.
 - c) Unless shown on the approved drawings, no approval is hereby granted for the display of any sign or advertisement. These must form the subject of a separate application for advertisement consent.
 - d) No activity is to take place outside the premises, unless clearly indicated on the approved drawings, and no crates or other items are to be stored outside. The placing/installation of any structures or facilities in front of the premises, unless indicated on the approved drawings, must be the subject of a separate clearance/permission from MEPA, now known as the Planning Authority.
- 5 The communal parking area shall only be used for the parking of vehicles and shall be kept available at all times for staff, other visitors, and customers. The parking area shall be adequately lit and sign-posted, and the parking bays properly demarcated in

accordance with the standards set out in the Development Control Design Policy, Guidance and Standards 2015. The use of the parking area for storage, industrial, or commercial activity is prohibited.

- 6
- a) This development permission is valid for a period of FIVE (5) YEARS from the date of publication of the decision in the press but will cease to be valid if the development is not completed by the end of this validity period.
 - b) This permission relates only to the development as specifically indicated on the approved drawings. This permission does not sanction any other illegal development that may exist on the site.
 - c) Copies of all approved drawings and documents shall be available for inspection on site by MEPA, now known as the Planning Authority, staff at all reasonable times. All works shall be carried out strictly in accordance with the approved drawings, documents and conditions of this permission. Where a matter is not specified, then the conditions of this permission and of Development Control Policy and Design Guidance shall take precedence and shall modify the drawings and documents accordingly.
 - d) Where applicable, all building works shall be erected in accordance with the official alignment and official/existing finished road levels as set out on site by MEPA, now known as the Planning Authority's Land Surveyor. The Setting Out Request Notice must be submitted to the Land Survey Unit of MEPA, now known as the Planning Authority, when the setting out of the alignment and levels is required.
 - e) Where an officially schemed street, within the development zone, bordering the site is unopened or unformed, it shall be opened up and brought up to its proper, approved and official formation levels prior to the commencement of any development hereby being permitted.
 - f) Before any part of the development hereby permitted commences, the enclosed green copy of this development permission shall be displayed on the site. This must be mounted on a notice board, suitably protected from the weather and located not more than 2 metres above ground level at a point on the site boundary where it is clearly visible and can be easily read from the street. The copy of the permission must be maintained in a good condition and it shall remain displayed on the site until the works are complete.
 - g) A Commencement Notice is to be submitted to the Planning Authority, by the perit on behalf of the applicant, at least FIVE DAYS prior to the date of commencement of works or utilisation of the permission. Failure to submit the Commencement Notice (with all fields correctly completed) or to submit it within the required timeframe shall invalidate the Notice and shall result in the imposition of fines according to Schedule D of Legal Notice 277 of 2012, or its amendments, or its replacements. In addition, **if the applicant fails to submit the Commencement Notice or the Commencement Notice submitted is invalid, the relative permission shall be considered as never having been utilised** - Article 72(4) of the Development Planning Act (2016).
 - h) Where applicable, the development hereby permitted shall be carried out in accordance with the provisions of the Environmental Management Construction Site Regulations, Legal Notice 295 of 2007 (or subsequent amendments). Any hoarding shall be erected in accordance with Schedule 2 of the same Regulations.
 - i) All new developments shall be provided with a water cistern to store rainwater run-off as

required by the Energy Performance of Buildings Regulations (2012) [published through Legal Notice 376 of 2012 and any amendments thereto] and to Technical Guidance Document F [published through Government Notice 1002 of 2006 and any amendments thereto] which are prevailing at the time of construction of the development.

j) Where applicable, the ramp leading down to the underlying basement/garages for private car parking shall at no point be steeper than 1:5 from the back edge of the pavement. If there are more than 5 public car parking spaces or garages, the ramp shall not be steeper than 1:8 (or 1:10 if helical). The ramp shall always be so formed that it does not encroach onto the pavement.

k) Where applicable, an area of a depth of 4 metres from the pavement, with a gradient not steeper than 1:10, shall be provided within the site for vehicles to wait at pavement level before entering the street.

l) Where applicable, any garages/parking spaces shall only be used for the parking of private cars and they shall be kept available at all times for this purpose.

m) Where applicable, any approved stores shall be used for domestic storage only and shall be physically and internally linked to the overlying dwellings.

n) The height of the development shall not exceed the permitted number of floors and the height in metres as indicated on the approved drawings.

o) No steps, ramps or street furniture are to be constructed on or encroached onto the public pavement or road.

p) Any doors and windows, the lower edge of which is less than 2m above road level, and any gates shall not open outwards onto a public pavement or road.

q) Where applicable, the garage door opening(s) at ground floor level, overlooking the public street, shall be fitted with a solid aperture within the thickness of the external wall along the building alignment. This aperture shall be of the same colour of the other apertures on the elevation, unless otherwise indicated on the approved drawings. This aperture shall be fitted prior to the issue of any Compliance Certificate (partial or full) on the whole or any part of the development hereby approved. No gates are permitted on this opening.

r) Where present, window grilles (including 'pregnant' windows), sills, planters and other similar elements which are part of or fixed to the facade of buildings, the lower edge of which is less than 2 metres above road level, shall not project more than 0.15 metres from the facade over a public pavement or street.

s) Air conditioning units shall not be located on the facades of the building which are visible from a public space/street.

t) There shall be no service pipes, cables or wires visible on the front elevation or on any other elevations of the building which are visible from the street or public space.

7 **Conditions imposed and enforced by other entities**

A. Where construction activity is involved:

(a) The applicant shall:

(i) Appoint a Project Supervisor for the Design Stage and a Project Supervisor for the Construction Stage and any such appointment shall be terminated, changed or renewed as necessary. The same person may be appointed to act as project supervisor for both the design and construction stage, if that person is competent to undertake the duties involved and

(ii) Keep a health and safety file prepared by the Project Supervisor for the Design Stage.

(b) When the construction works related to this application are scheduled to last longer than thirty working days and on which more than twenty workers are occupied simultaneously, or on which the volume of work is scheduled to exceed five hundred person-days, the project supervisor **shall communicate a prior notice to the Occupational Health and Safety Authority (OHSA) at least four calendar weeks before commencement of works.**

(c) The Project Supervisor for the Design Stage shall **draw up a health and safety plan** which sets out the occupational health and safety rules applicable to the construction activities concerned, outlining the measures to ensure cooperation between different contractors and shall also include specific measures concerning occupational risks that may be present at this site.

B. Where the development concerns a change of use to a place of work, the applicant shall obtain a Perit's declaration that the building conforms to the requirements of LN 44 of 2002.

C. Where the development concerns a place of work:

The applicant shall:

(i) Obtain a Perit's declaration that the necessary requirements arising out of L.N. 44 of 2002 have been included in the plans and drawings; and

(ii) Obtain a Perit's declaration that the building conforms to the requirements of L.N. 44 of 2002.

D. The development is to strictly adhere to the 'Design Guidelines on fire safety for buildings in Malta' to ensure that all Fire Safety measures and provisions are addressed as indicated in the Design Guidelines on Fire Safety for Buildings in Malta, published by the DCID in 2004, (or other relevant standard, provided it is approved by the Civil Protection Department), Policies, and the Laws and Regulations of Malta.

E. Prior to laying of water and wastewater services in the road, the development shall comply with the requirements of Legal Notice 29/10 Part III (Roads in inhabited Areas) Clause 12.

F. In the event of an accidental discovery in the course of approved works, any cultural heritage feature discovered should not be damaged or disturbed and the Superintendence is to be immediately informed of such discovery. Any cultural heritage features discovered are to be investigated, evaluated and protected in line with the Cultural Heritage Act 2002 (CAP 445). The discovery of cultural heritage features may require the amendment of approved plans.

In terms of Article 72(3) of the Development Planning Act, 2016, the execution and validity of this permission is automatically temporarily **suspended** and no works as approved by the said development permission may commence before the lapse of the time period established in Article 13 of the Environment and Planning Review Tribunal Act and subsequently will remain so suspended if the Tribunal so decides in accordance with the Environment and Planning Review Tribunal Act.

Where the approved drawings and/or documents are dimensioned, then the declared dimensions shall prevail over the actual size as depicted on the approved drawings and/or documents.

Developers are advised to check the invert level to the sewer main with the Water Services Corporation as they would have to make their own arrangements where a gravity service connection is not possible. In these cases, the architect has to indicate the solutions envisaged and to indicate on the plan what needs to be carried out and obtain approval from WSC. Developers are further reminded that connection of storm water into main sewers is not allowed.

If the declaration of ownership, as contained in the application form, is determined as incorrect by a Court of Law, then the said Court of Law can declare this development permission as null and void. This development permission does not remove or replace the need to obtain the consent of the land/building owner to this development before it is carried out. Furthermore, it does not imply that consent will necessarily be forthcoming nor does it bind the land/building owner to agree to this development. Where the land/building is owned or administered by the Government of Malta a specific clearance and agreement must be obtained for this development from the Land and/or Estate Management Departments.

This development permission is granted saving third party rights. This permission does not exonerate the applicant from obtaining any other necessary permission, license, clearance or approval required from any Government department, local council, agency or authority, as required by any law or regulation.

This development permit does not authorise any storage of substances listed in Occupational Health and Safety Authority Act (Cap. 424) - Control of Major Accident Hazards Regulations, 2003, as amended, in quantities that would render this site an establishment within scope of these regulations. The storage and handling of said substances may require a new or amended development permission in line with current policies and regulations.

For any non-residential uses hereby being approved, prior to commencement of any works on site or any eventual permitted change of use, the applicant shall be required to contact the Environment and Resources Authority to obtain any necessary operational permit or registration. This requirement does not apply to Class 2B, 2C, 4A and 4B uses as listed in the Development Planning (Use Classes) Order 2014, or its subsequent amendments.

This decision is being published on 27 March 2019.

Marthese Debono
Secretary Planning Commission
Within Development Scheme

Notes to Applicant and Perit

Right for reconsideration

Where applicable, you have a right to submit a request for reconsideration to the Authority in terms of regulation 14 of Legal Notice 162 of 2016.

Right for appeal

You have a right to submit an appeal, against the decision, to the Environment and Planning Review Tribunal in terms of Article 13 of the Environment and Planning Review Tribunal Act, 2016.

Time limits

Requests for reconsideration or appeals must be made within 30 days from the publication of the decision notification in the local press as required by regulation 14(1) of Legal Notice 162 of 2016.

Fees to submit a request for reconsideration or appeal

In either case, there is a fee to be paid which should accompany the request for reconsideration or the appeal. The fees are as follows:

For reconsideration - 3% of the Development Permit Fee paid in respect of the original application, subject to a minimum of €69.88.

For appeal - 5% of DPF (Development Permit Fee) paid in respect of the original application, subject to a minimum of €150 + €50 administrative fee (LN 112 of 2016).

Submission of request for reconsideration or appeal

With regards to requests for reconsideration, Form PA 4/16 must be used for submission. All fields of the Form must be filled in as appropriate. Requests for reconsideration can only be submitted electronically.

With regards to appeals, as required by Article 13 of the Environment and Planning Review Tribunal Act, 2016, the submission must include the detailed grounds for appeal and the requests being made by the appellant. Appeals must be submitted physically at the offices of the Environment and Planning Review Tribunal, St. Francis Ditch, Floriana.

Important Notice

In view of the provisions of Article 72(4) of the Development Planning Act (2016), a Commencement Notice is to be submitted to the Planning Authority, by the perit on behalf of the applicant, at least FIVE DAYS prior to the date of commencement of works or utilisation of the permission. Failure to submit the Commencement Notice (with all fields correctly completed) or failure to submit it within the required timeframe shall invalidate the Notice and shall result in the imposition of fines according to Schedule D of Legal Notice 277 of 2012, or its amendments, or its replacements. In addition, if the applicant fails to submit the Commencement Notice or the Commencement Notice submitted is invalid, the relative permission shall be considered as never having been utilised.

-PADCN-

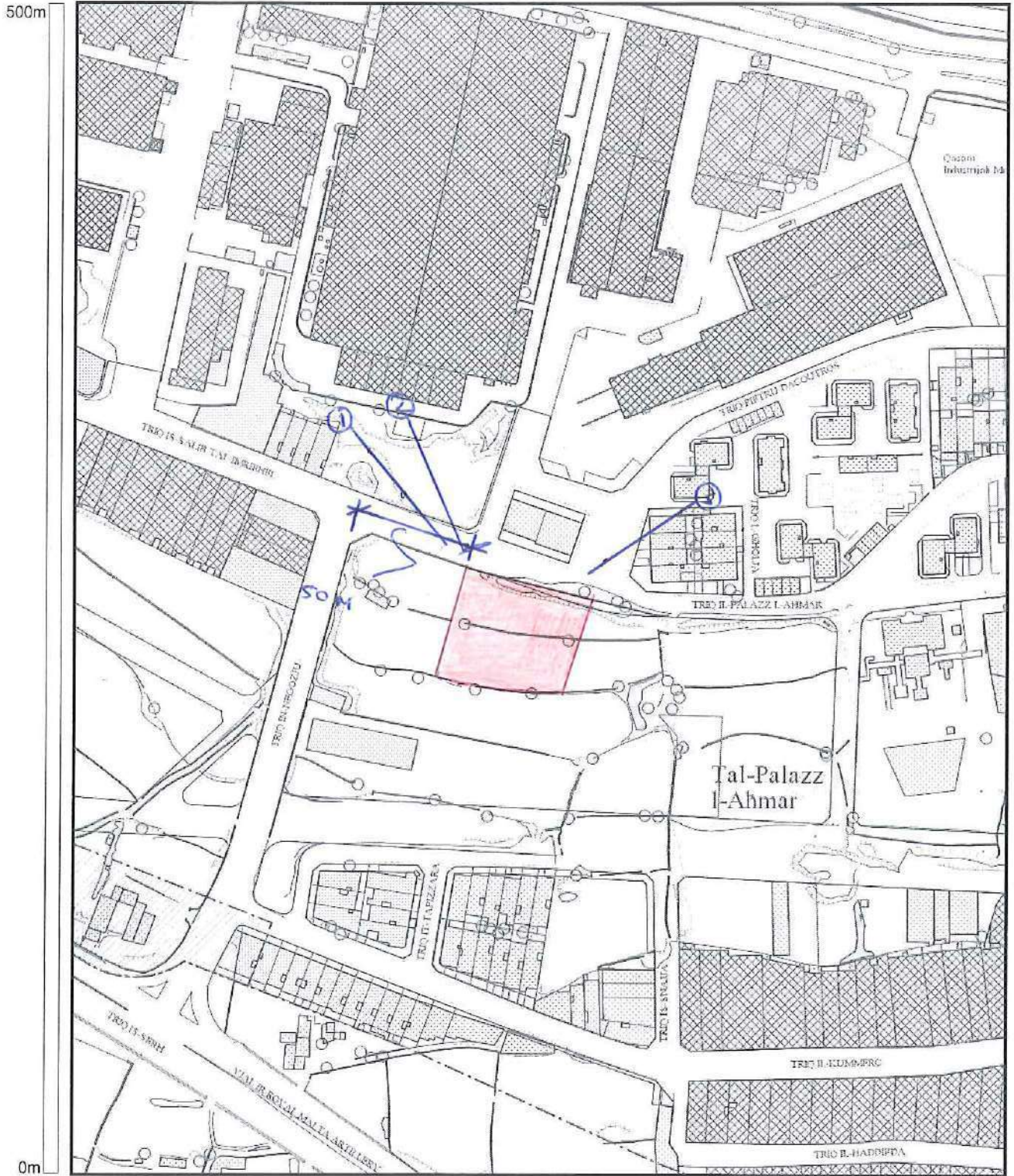

Min Easting 52019.49, Min Northing 71598.1, Max Easting 52419.49, Max Northing 72098.1



Planning Authority - www.pa.org.mt

St. Francis Ravelin
 Floriana FRN 1230, Malta
 PO Box 200, Marsa MRS 1000, Malta
 Tel: +356 2290 0000 Fax: +356 22902295

Site Plan, Scale 1:2500
 Printed on: Wednesday, December 07, 2016

Not to be used for interpretation or scaling of scheme alignments
 Copyright © PA - Planning Authority. Not for resale.

Perit Ivan A. Bondin
 B.E.&A.(Hons.), M.Sc.(Ed.), A.&C.I.,
 38, Triq ix- Xbiel M'Abbi, MQB 1320
 Tel: 2168 3147 - Mob: 7939 4078
 Email: bondin@convel.net

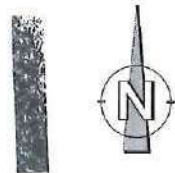

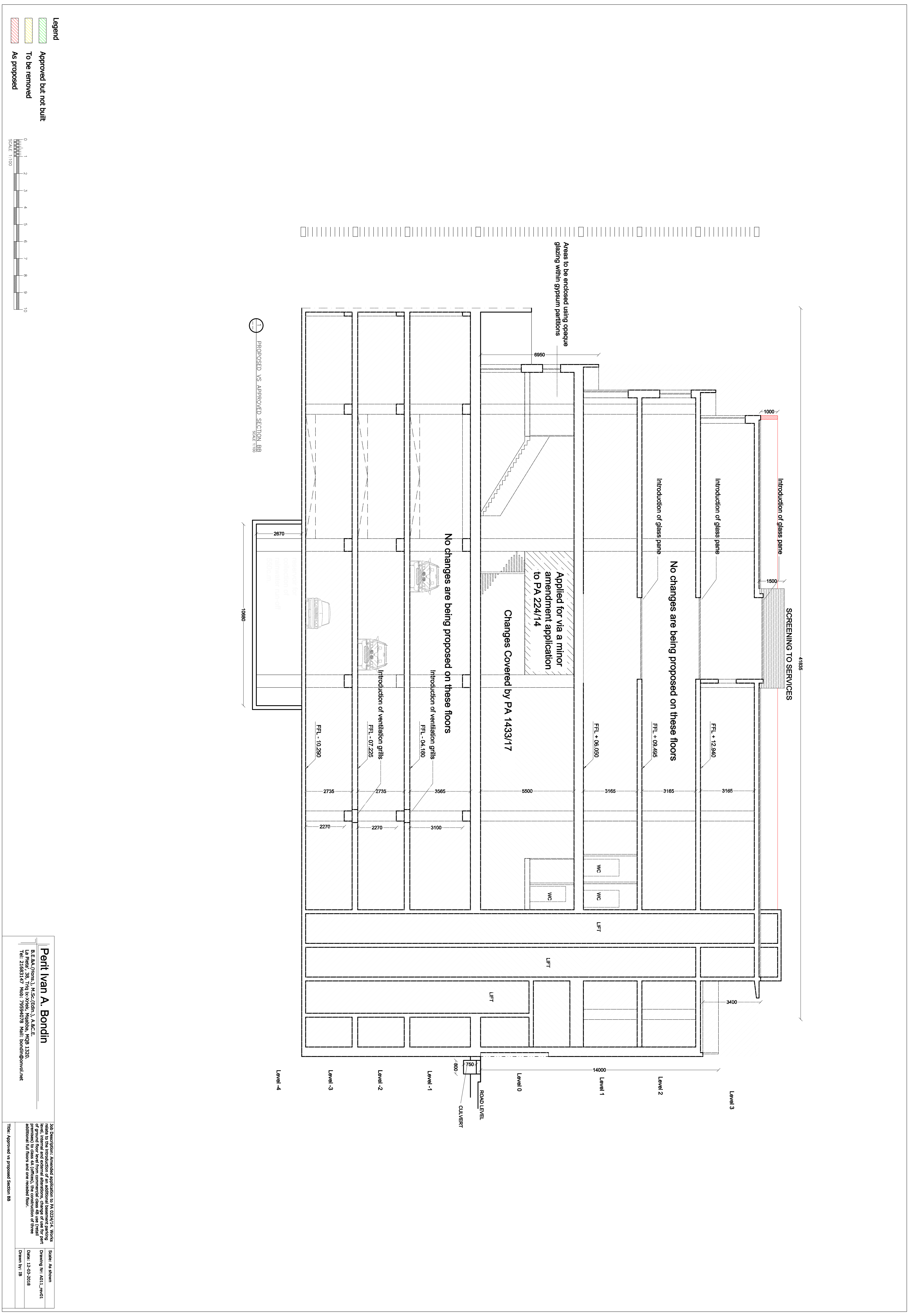

Perit Ivan A. Bondin
 B.E. (Arch), M.Sc. (Urban Planning), A.R.C. (No. 1320)
 Tel: 21653147 Mob: 79594078 Mail: bondin@bondin.net

Job Description: Amended application to PA 0228/14. Works relate to the introduction of an additional basement parking level to the existing building. The application is for the conversion of three levels of ground floor level from commercial class 4B use (retail) to parking use. The proposed works are shown in red.

Title: Approved vs proposed Section BB

Scale: As shown
 Drawing No: 2011_Lev01
 Date: 12-03-2018
 Drawn by: IB

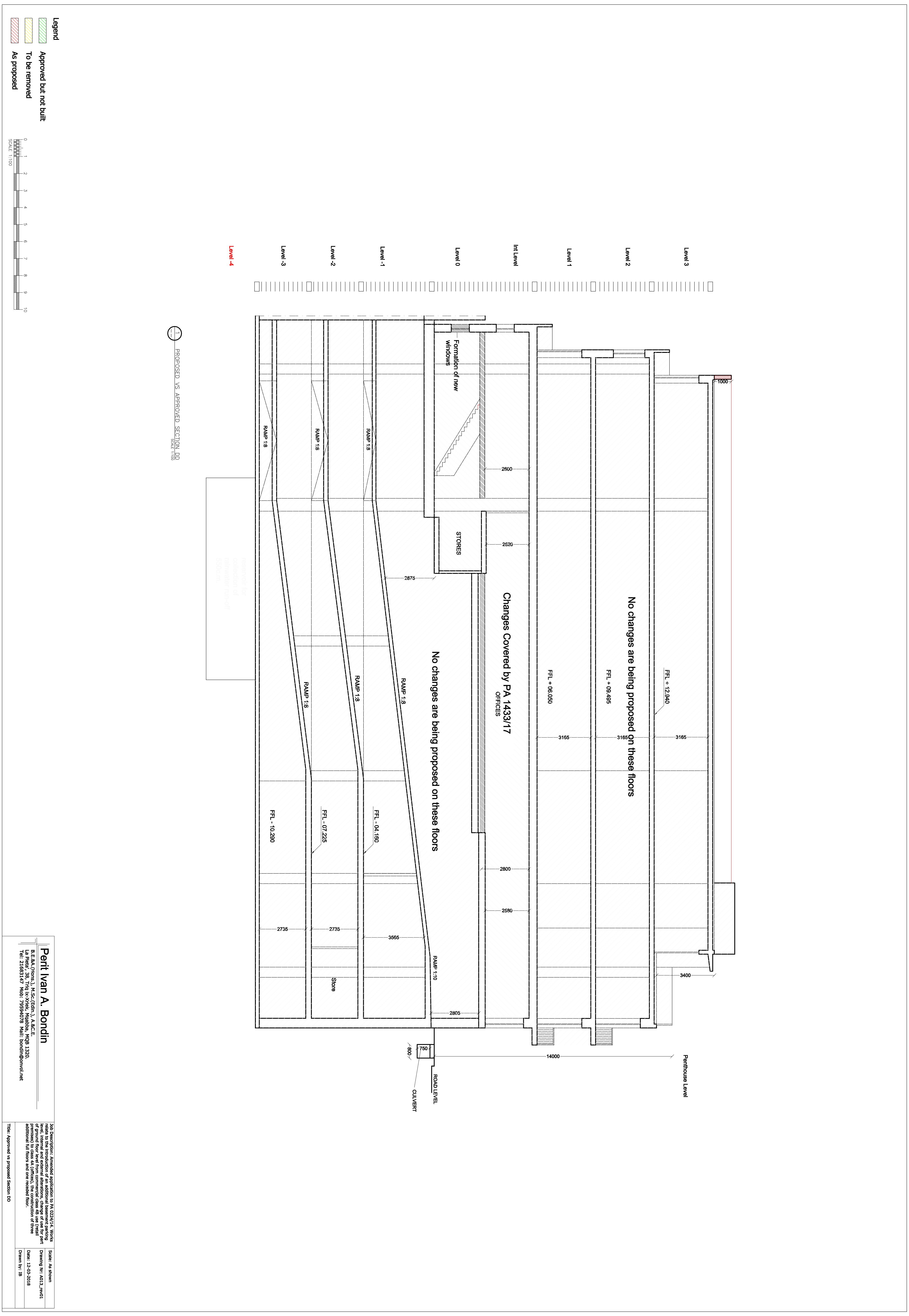

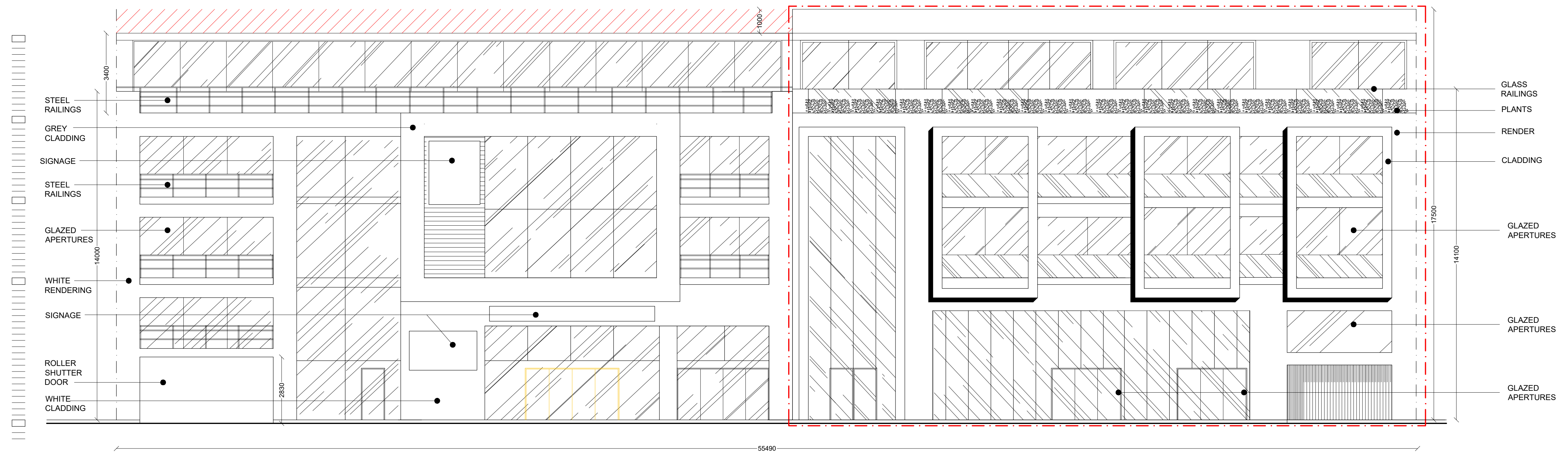

PROPOSED FRONT ELEVATION
SCALE 1:100

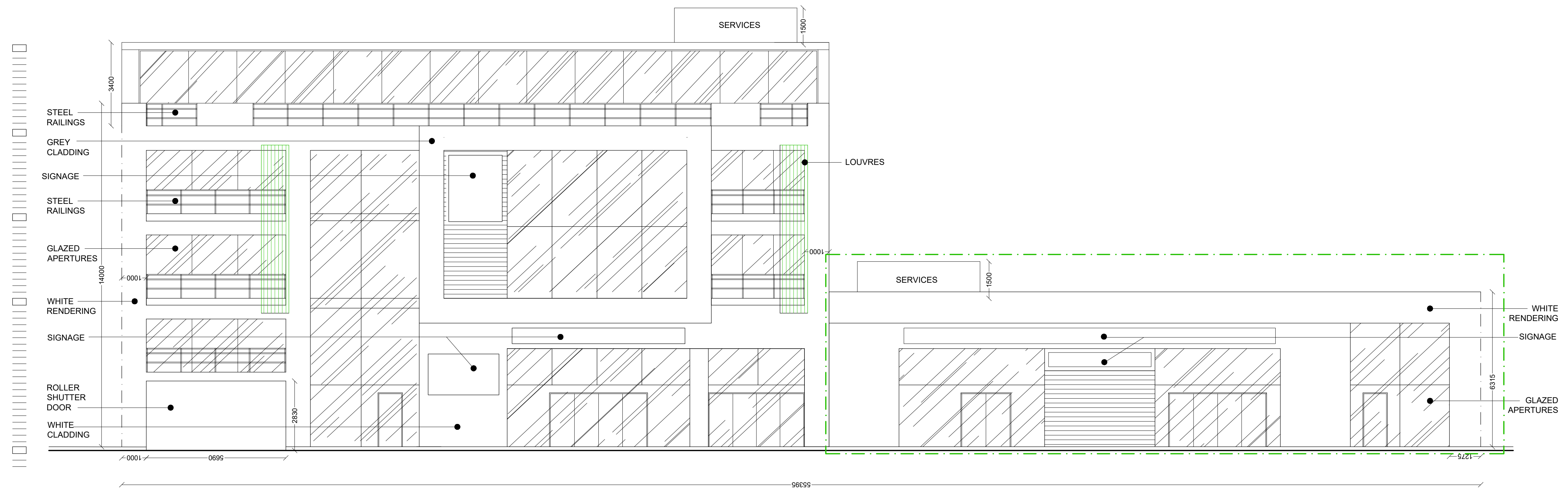

APPROVED FRONT ELEVATION
SCALE 1:100

- Legend**
- Approved but not built
 - To be removed
 - As proposed

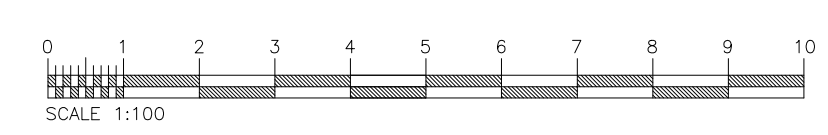

| | | |
|--|---|--|
| <p>Perit Ivan A. Bondin B.E.&A.(Hons.), M.Sc.(Edin.), A.&C.E. La Pietra, 38, Triq ix-Kriek, Mgabba, MQB 1320. Tel: 21683147 Mob: 79594078 Mail: bondin@onvol.net</p> | <p>Job Description: Amended application to PA 0224/14. Works relate to the introduction of an additional basement parking level, internal and external alterations, change of use for part of ground floor level from commercial class 4B use (retail premises) to class 4A (offices), the construction of three additional full floors and one recessed floor.</p> | <p>Scale: As shown Drawing Nr: A015_rev02 Date: 11-05-2018 Drawn by: IB</p> |
| | <p>Title: Approved & proposed Elevation</p> | |

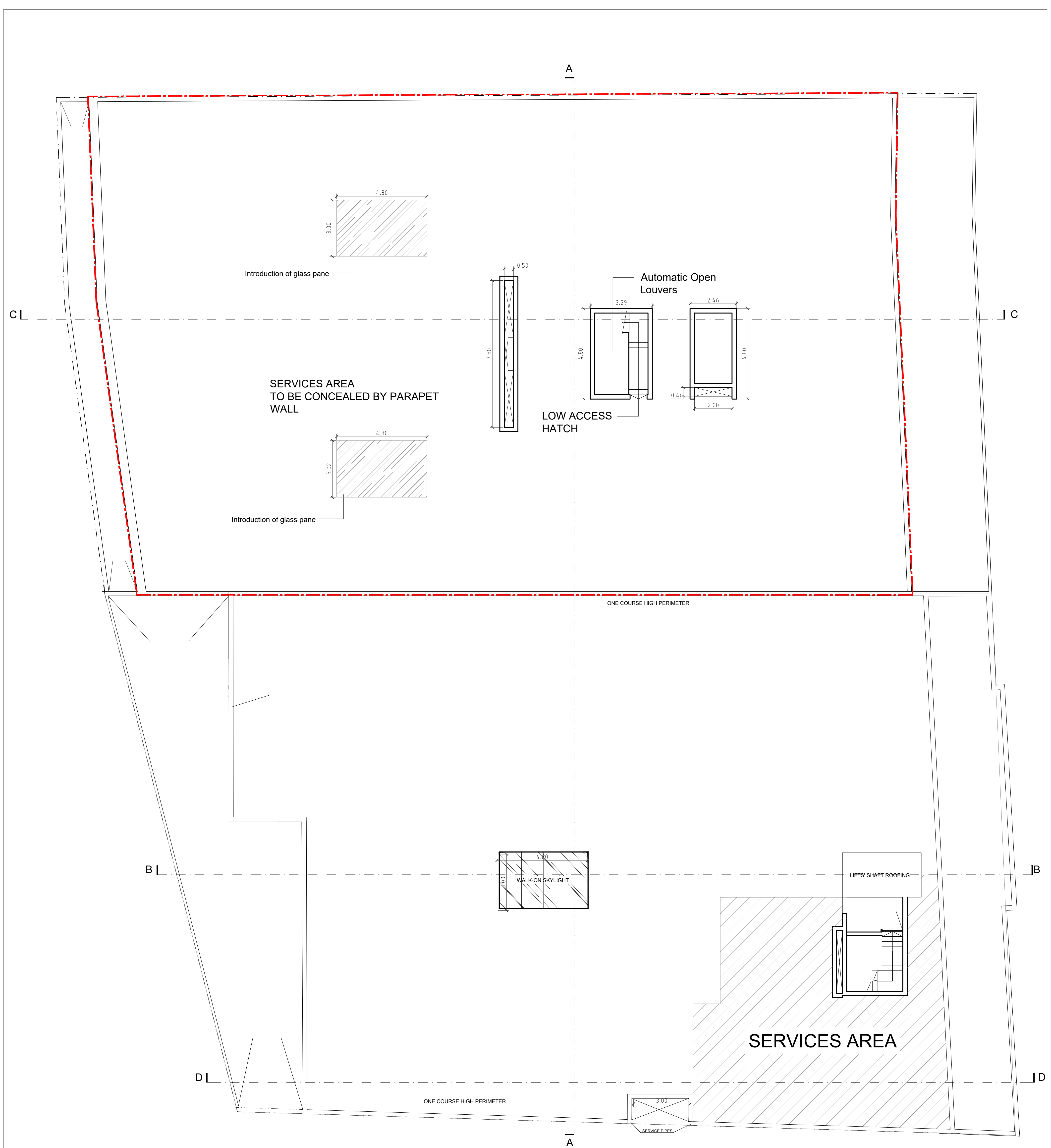

1 PROPOSED ROOF LEVEL

ib projects
 Perit Ivan Bondin
 B.E.&A.(Hons.), M.Sc.(Edin.), A.&C.E.
 E: info@ibprojects.com.mt
 A: Nr.1, Triq Il-Blata l-Kahla, Santa Venera, SVR 1813
 A: Nr. 38, Triq ix-Xriek, Mqabba, MQB 1320
 T: +356 21498850 / +356 21683147
 M: +356 79594078

- To Construct
- To Demolish
- Approved but not constructed
- As construct to sanction

Project: Amended application to PA/00224/14. Works relate to the introduction of an additional basement parking level, internal and external alterations, change of use for part of ground floor level from commercial class 4B use (retail premises) to class 4A (offices), the construction of three additional full floors and one receded floor.

Drawing Title: Approved vs Proposed Roof Level
 Date: 03/01/2019

Scale: 1:100 A1
 Drawing No.: 001_R06
 Drawn By: CC
 Checked By: IB

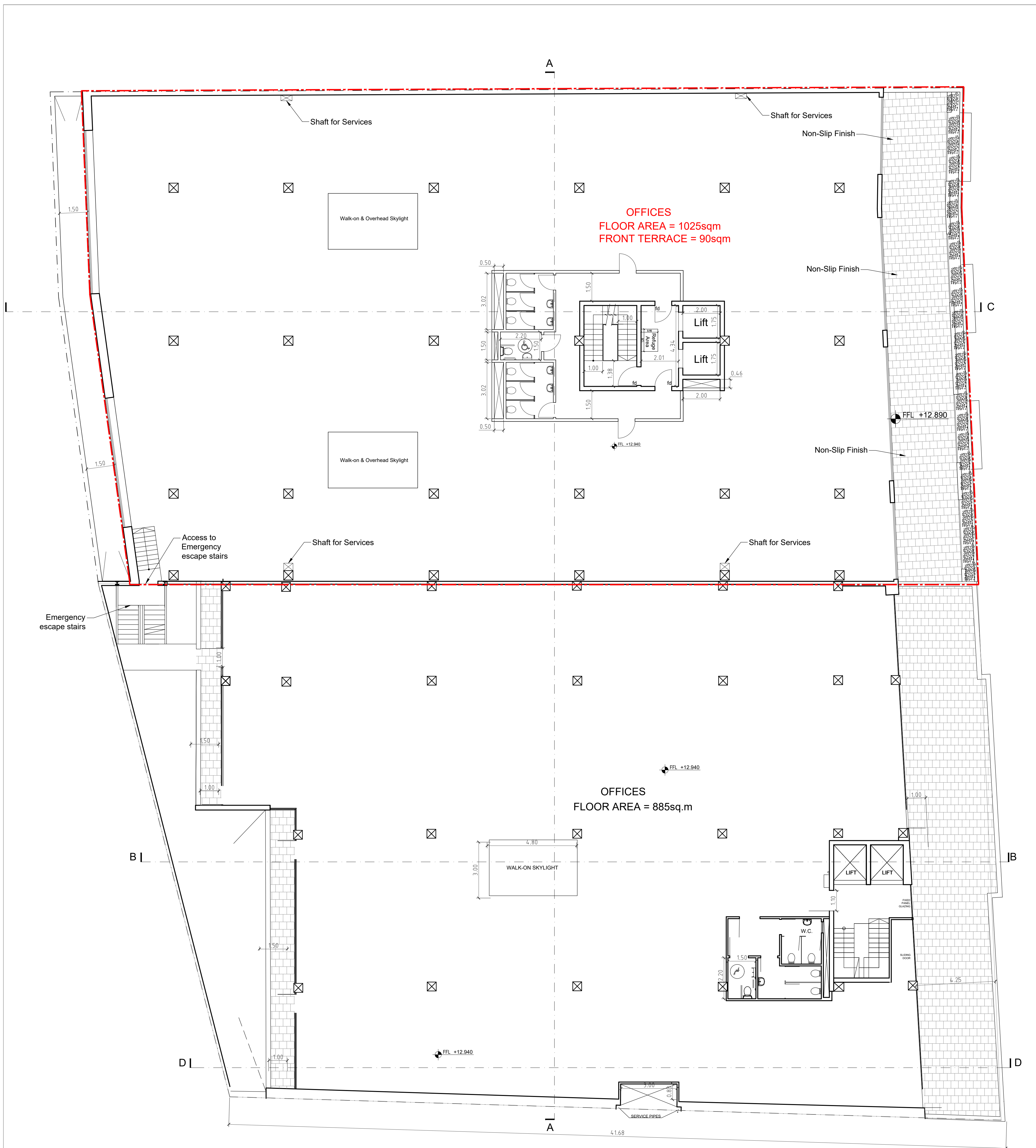

1 PROPOSED THIRD (RECEDED) FLOOR LEVEL

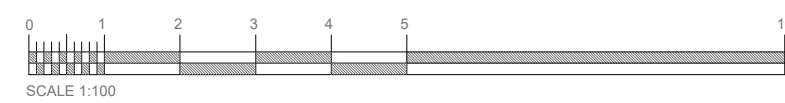

Drawing Notes:
 - All access for all doors shall be min. 900mm wide when open.
 - There shall be no ridges at the joints or anywhere else in the paving surface
 - All external paving materials shall have a non-slip finish



Perit Ivan Bondin
 B.E.&A.(Hons.), M.Sc.(Edin.), A.&C.E.
 E: info@ibprojects.com.mt
 A: Nr.1, Triq Il-Blata l-Kahla, Santa Venera, SVR 1813
 A: Nr. 38, Triq ix-Xriek, Mqabba, MQB 1320
 T: +356 21498850 / +356 21683147
 M: +356 79594078

- To Construct
- To Demolish
- Approved but not constructed
- As construct to sanction

Project: Amended application to PA/00224/14. Works relate to the introduction of an additional basement parking level, internal and external alterations, change of use for part of ground floor level from commercial class 4B use (retail premises) to class 4A (offices), the construction of three additional full floors and one receded floor.

Drawing Title: Approved vs Proposed Third (Receded) Floor Level
 Date: 03/01/2019

Scale: 1:100 A1
 Drawing No.: 002_R06
 Drawn By: CC
 Checked By: IB

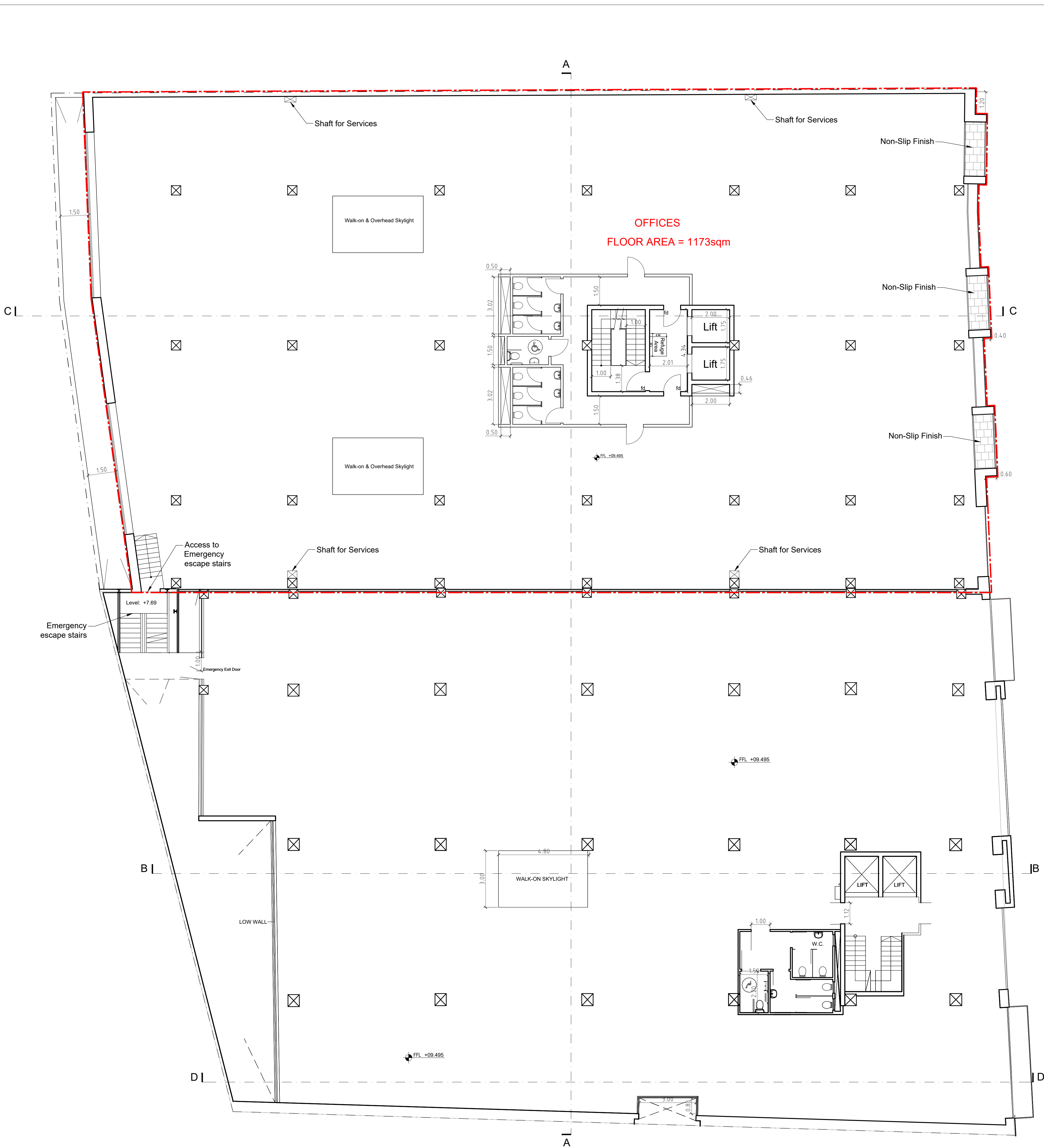

1 PROPOSED SECOND FLOOR LEVEL

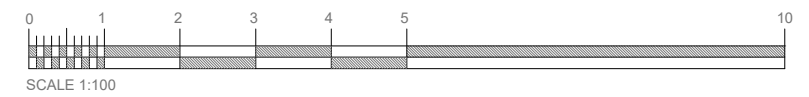

Drawing Notes:
 - All access for all doors shall be min. 900mm wide when open.
 - There shall be no ridges at the joints or anywhere else in the paving surface
 - All external paving materials shall have a non-slip finish

ib projects
 Perit Ivan Bondin
 B.E.&A.(Hons.), M.Sc.(Edin.), A.&C.E.
 E: info@ibprojects.com.mt
 A: Nr.1, Triq Il-Blata l-Kahla, Santa Venera, SVR 1813
 A: Nr. 38, Triq ix-Xriek, Mqabba, MQB 1320
 T: +356 21498850 / +356 21683147
 M: +356 79594078

- To Construct
- To Demolish
- Approved but not constructed
- As construct to sanction

Project: Amended application to PA/00224/14. Works relate to the introduction of an additional basement parking level, internal and external alterations, change of use for part of ground floor level from commercial class 4B use (retail premises) to class 4A (offices), the construction of three additional full floors and one recessed floor.

Drawing Title: Approved vs Proposed Second Floor Level
 Date: 03/01/2019

Scale: 1:100 A1
 Drawing No.: 003_R06
 Drawn By: CC
 Checked By: IB

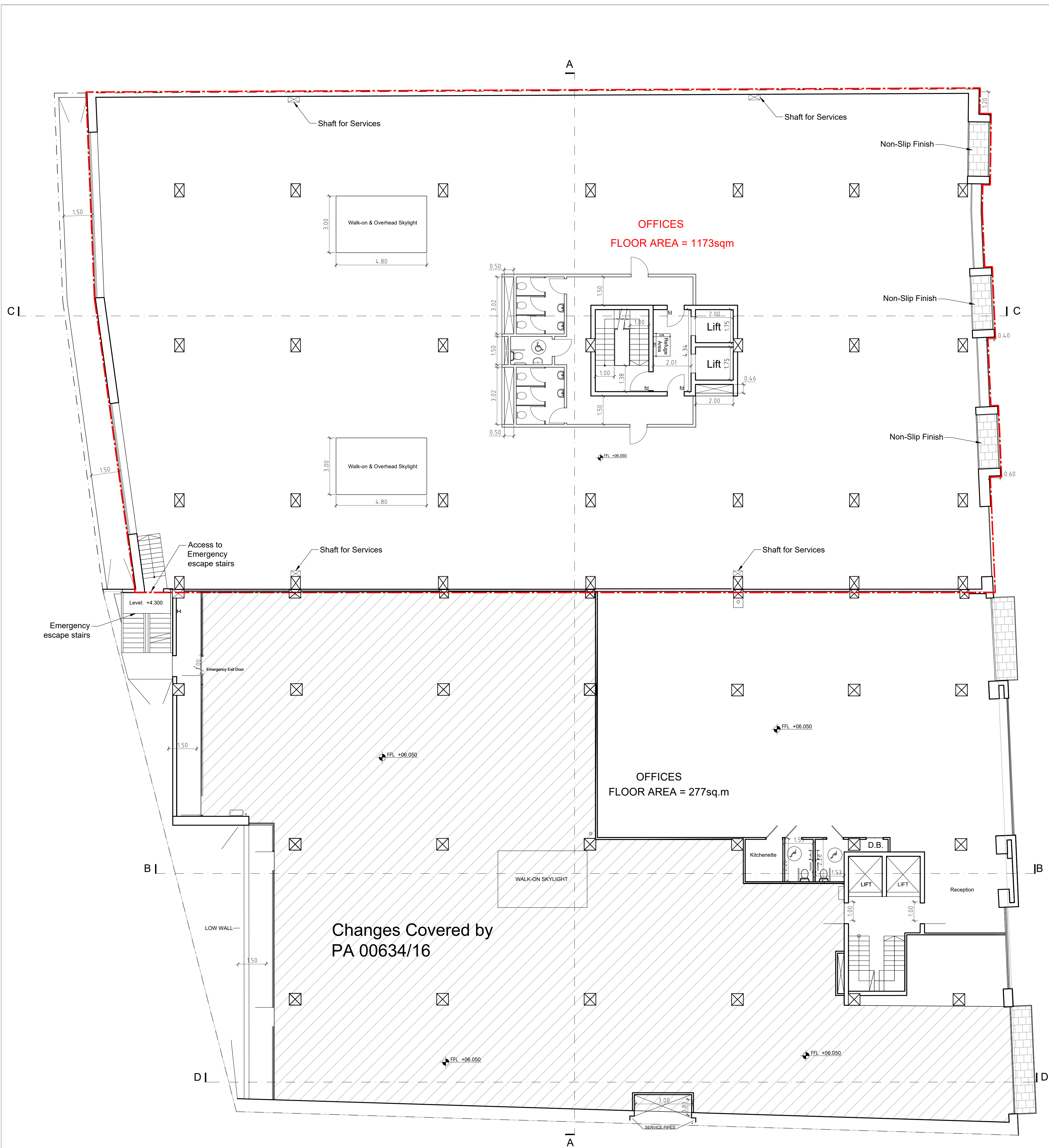

1 PROPOSED FIRST FLOOR LEVEL

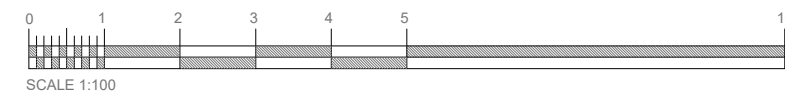

Drawing Notes:
 - All access for all doors shall be min. 900mm wide when open.
 - There shall be no ridges at the joints or anywhere else in the paving surface
 - All external paving materials shall have a non-slip finish

Perit Ivan Bondin
 B.E.&A.(Hons.), M.Sc.(Edin.), A.&C.E.
 E: info@ibprojects.com.mt
 A: Nr.1, Triq Il-Blata l-Kahla, Santa Venera, SVR 1813
 A: Nr. 38, Triq ix-Xriek, Mqabba, MQB 1320
 T: +356 21498850 / +356 21683147
 M: +356 79594078

Legend:

- To Construct
- To Demolish
- Approved but not constructed
- As construct to sanction

Project: Amended application to PA/00224/14. Works relate to the introduction of an additional basement parking level, internal and external alterations, change of use for part of ground floor level from commercial class 4B use (retail premises) to class 4A (offices), the construction of three additional full floors and one recessed floor.

Drawing Title: Approved vs Proposed First Floor Level
Date: 03/01/2019

Scale: 1:100 A1
Drawing No.: 004_R06
Drawn By: CC
Checked By: IB

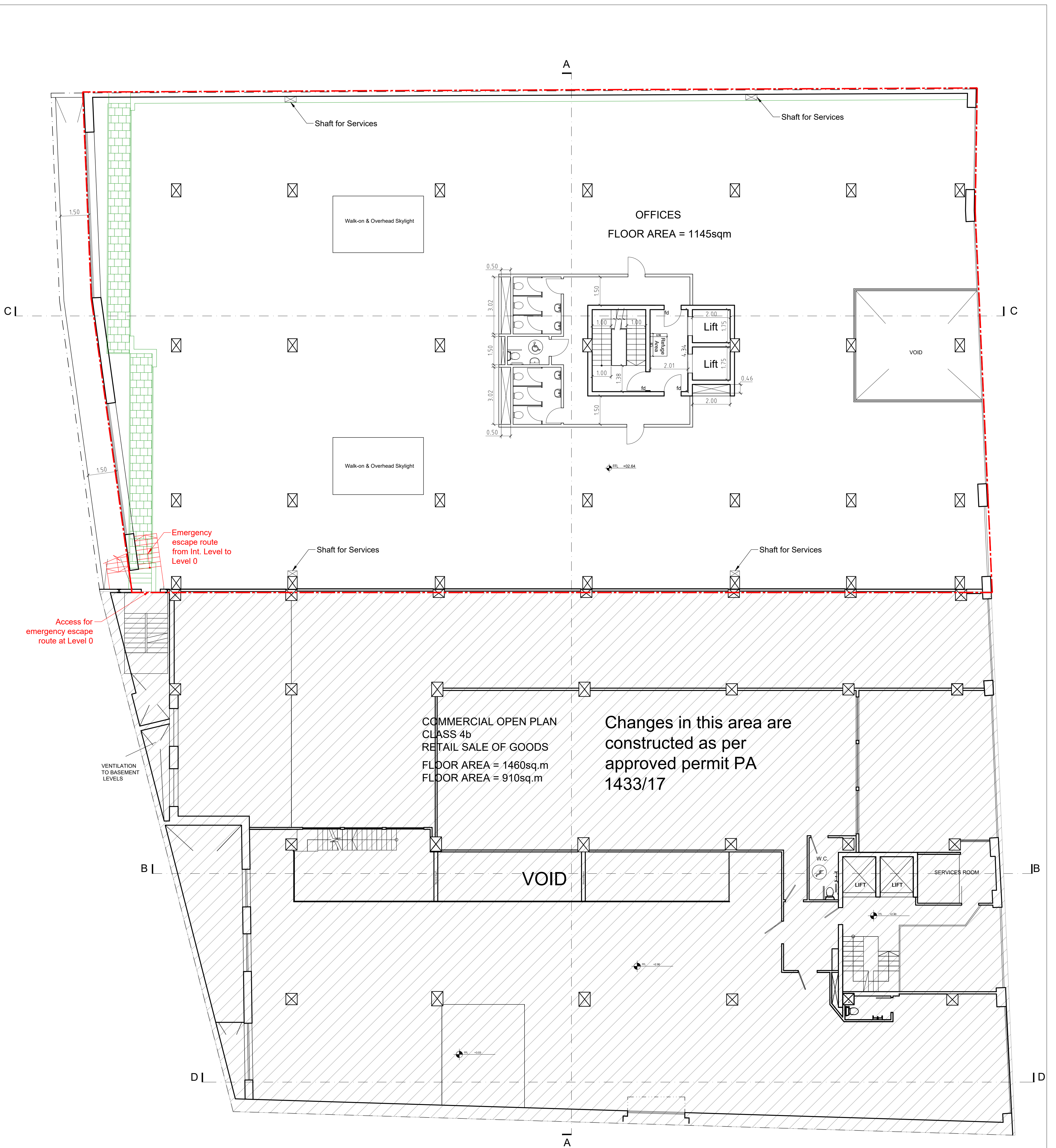

1 PROPOSED INTERMEDIATE LEVEL

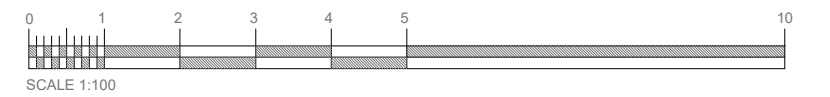

Drawing Notes:
 - All access for all doors shall be min. 900mm wide when open.
 - There shall be no ridges at the joints or anywhere else in the paving surface
 - All external paving materials shall have a non-slip finish

ib projects
 Perit Ivan Bondin
 B.E.&A.(Hons.), M.Sc.(Edin.), A.&C.E.
 E: info@ibprojects.com.mt
 A: Nr.1, Triq Il-Blata l-Kahla, Santa Venera, SVR 1813
 A: Nr. 38, Triq ix-Xriek, Mqabba, MQB 1320
 T: +356 21498850 / +356 21683147
 M: +356 79594078

- To Construct
- To Demolish
- Approved but not constructed
- As construct to sanction

Project: Amended application to PA/00224/14. Works relate to the introduction of an additional basement parking level, internal and external alterations, change of use for part of ground floor level from commercial class 4B use (retail premises) to class 4A (offices), the construction of three additional full floors and one recessed floor.

Drawing Title: Approved vs Proposed Intermediate Level
 Date: 03/01/2019

Scale: 1:100 A1
 Drawing No.: 005_R06
 Drawn By: CC
 Checked By: IB

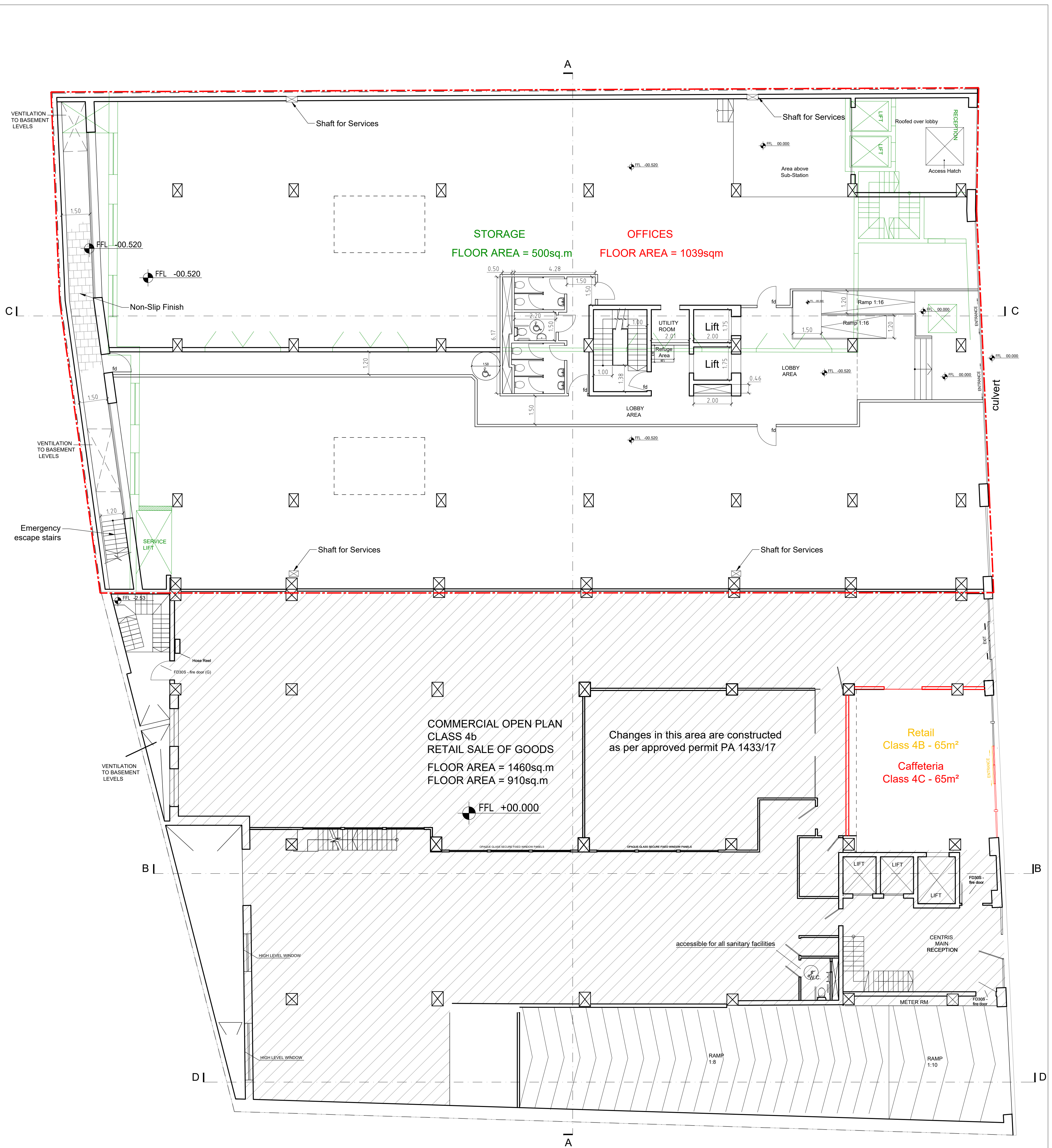

1 PROPOSED LEVEL 0 (GROUND FLOOR)

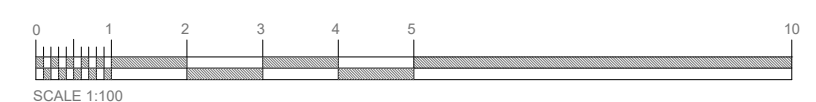

- Drawing Notes:
- All access for all doors shall be min. 900mm wide when open.
 - There shall be no ridges at the joints or anywhere else in the paving surface
 - All external paving materials shall have a non-slip finish



Perit Ivan Bondin
 B.E.&A.(Hons.), M.Sc.(Edin.), A.&C.E.
 E: info@ibprojects.com.mt
 A: Nr.1, Triq Il-Blata l-Kahla, Santa Venera, SVR 1813
 A: Nr. 38, Triq ix-Xriek, Mqabba, MQB 1320
 T: +356 21498850 / +356 21683147
 M: +356 79594078

- To Construct
- To Demolish
- Approved but not constructed
- As construct to sanction

Project: Amended application to PA/00224/14. Works relate to the introduction of an additional basement parking level, internal and external alterations, change of use for part of ground floor level from commercial class 4B use (retail premises) to class 4A (offices), the construction of three additional full floors and one recessed floor.

Drawing Title: Approved vs Proposed Level 0 (Ground Floor Level)
Date: 03/01/2019

Scale: 1:100 A1
Drawing No.: 006_R06
Drawn By: CC
Checked By: IB



1 PROPOSED LEVEL -1

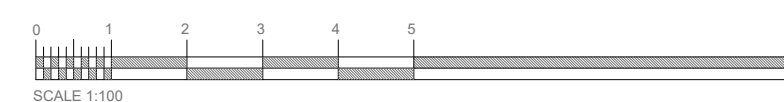

- Drawing Notes:
- All access for all doors shall be min. 900mm wide when open.
 - There shall be no ridges at the joints or anywhere else in the paving surface
 - All external paving materials shall have a non-slip finish



Perit Ivan Bondin

B.E.&A.(Hons.), M.Sc.(Edin.), A.&C.E.

E: info@ibprojects.com.mt

A: Nr.1, Triq Il-Blata l-Kahla, Santa Venera, SVR 1813

A: Nr. 38, Triq ix-Xriek, Mqabba, MQB 1320

T: +356 21498850 / +356 21683147

M: +356 79594078

- To Construct
- To Demolish
- Approved but not constructed
- As construct to sanction

Project: Amended application to PA/00224/14. Works relate to the introduction of an additional basement parking level, internal and external alterations, change of use for part of ground floor level from commercial class 4B use (retail premises) to class 4A (offices), the construction of three additional full floors and one recessed floor.

Drawing Title: Approved vs Proposed Basement Level -1

Date: 03/01/2019

Scale: 1:100 A1

Drawing No.: 007_R07

Drawn By: CC

Checked By: IB



1 PROPOSED LEVEL -2

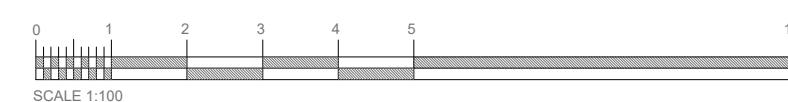

Drawing Notes:
 - All access for all doors shall be min. 900mm wide when open.
 - There shall be no ridges at the joints or anywhere else in the paving surface
 - All external paving materials shall have a non-slip finish



Perit Ivan Bondin
 B.E.&A.(Hons.), M.Sc.(Edin.), A.&C.E.
 E: info@ibprojects.com.mt
 A: Nr.1, Triq Il-Blata l-Kahla, Santa Venera, SVR 1813
 A: Nr. 38, Triq ix-Xriek, Mqabba, MQB 1320
 T: +356 21498850 / +356 21683147
 M: +356 79594078

- To Construct
- To Demolish
- Approved but not constructed
- As construct to sanction

Project: Amended application to PA/00224/14. Works relate to the introduction of an additional basement parking level, internal and external alterations, change of use for part of ground floor level from commercial class 4B use (retail premises) to class 4A (offices), the construction of three additional full floors and one recessed floor.

Drawing Title: Approved vs Proposed Basement Level -2
 Date: 03/01/2019

Scale: 1:100 A1
 Drawing No.: 008_R07
 Drawn By: CC
 Checked By: IB

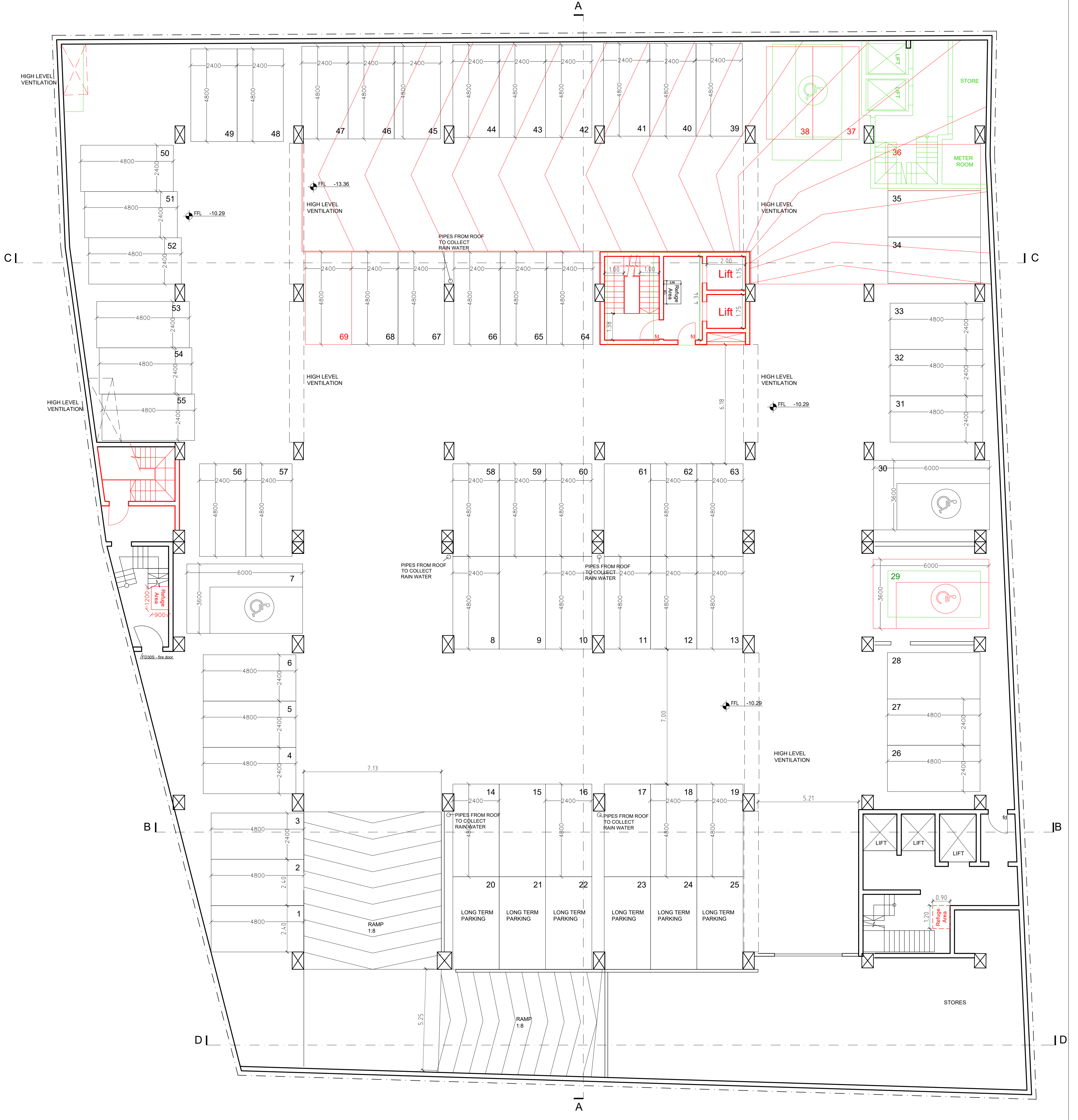

1 PROPOSED LEVEL -3

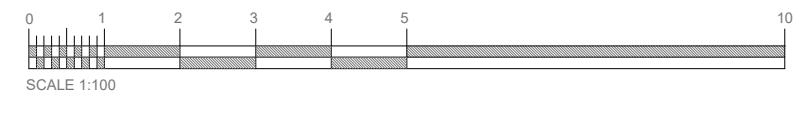

Drawing Notes:
 - All access for all doors shall be min. 900mm wide when open.
 - There shall be no ridges at the joints or anywhere else in the paving surface
 - All external paving materials shall have a non-slip finish

ib projects
 Perit Ivan Bondin
 B.E.&A.(Hons.), M.Sc.(Edin.), A.&C.E.
 E: info@ibprojects.com.mt
 A: Nr.1, Triq Il-Blata l-Kahla, Santa Venera, SVR 1813
 A: Nr. 38, Triq ix-Xriek, Mqabba, MQB 1320
 T: +356 21498850 / +356 21683147
 M: +356 79594078

- To Construct
- To Demolish
- Approved but not constructed
- As construct to sanction

Project: Amended application to PA/00224/14. Works relate to the introduction of an additional basement parking level, internal and external alterations, change of use for part of ground floor level from commercial class 4B use (retail premises) to class 4A (offices), the construction of three additional full floors and one recessed floor.

Drawing Title: Approved vs Proposed Basement Level -3
 Date: 03/01/2019

Scale: 1:100 A1
 Drawing No.: 009_R07
 Drawn By: CC
 Checked By: IB

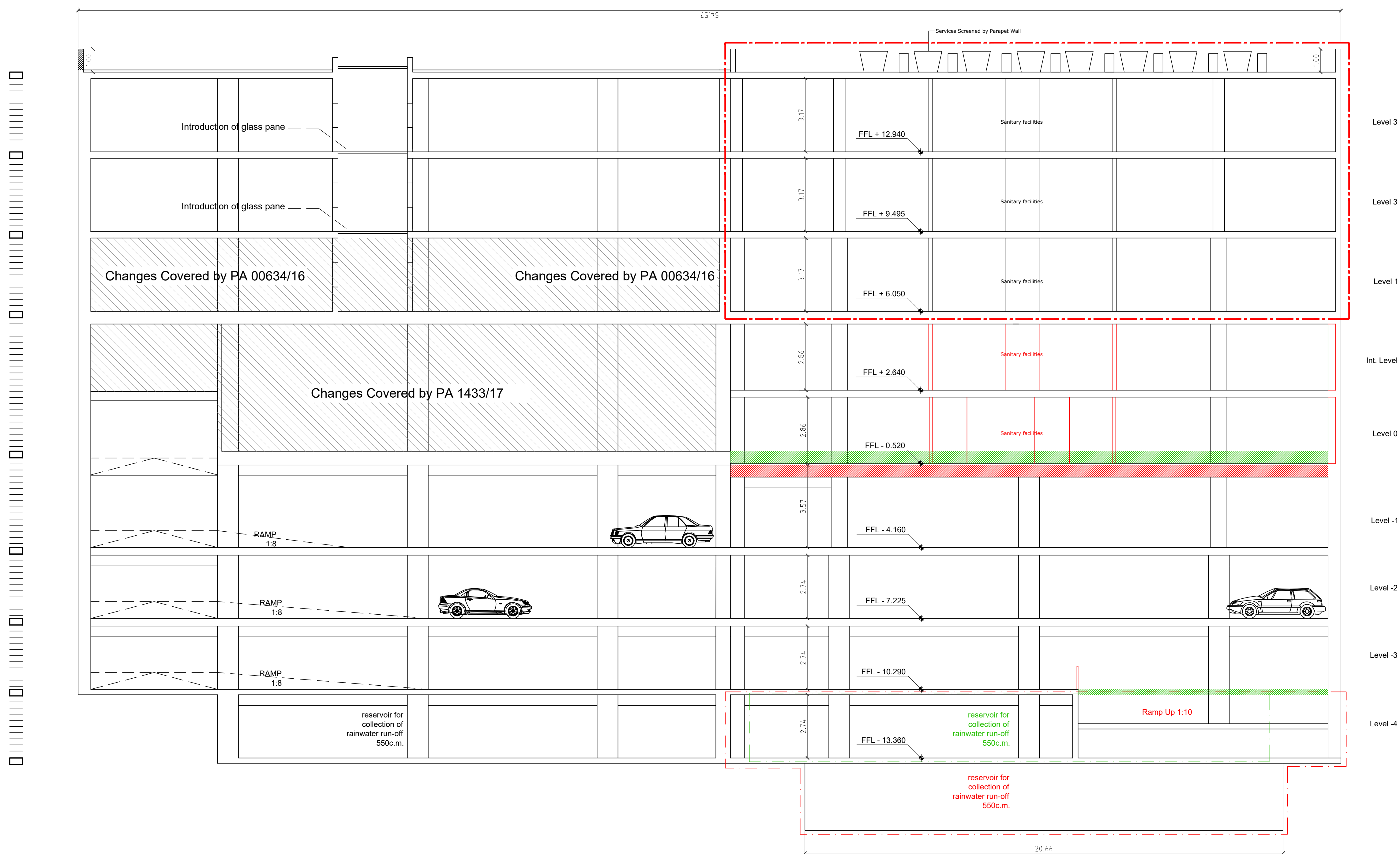

- To Construct
- To Demolish
- Approved but not constructed
- As construct to sanction

Project: Amended application to PA/00224/14. Works relate to the introduction of an additional basement parking level, internal and external alterations, change of use for part of ground floor level from commercial class 4B use (retail premises) to class 4A (offices), the construction of three additional full floors and one recessed floor.

Drawing: Approved vs Proposed
 Title: Section A-A

Date: 03/01/2019

Scale: As Noted A1

Drawing No.: 010_R04

Drawn By: CC

Checked By: IB

Copyright © Perit Ivan Bondin. All rights reserved. No part may be reproduced, stored in a retrieval system or transmitted in any form or by any means without the prior written permission of the author.

1 PROPOSED VS APPROVED SECTION A-A

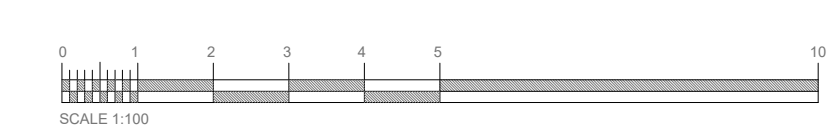

- Drawing Notes:
- All access for all doors shall be min. 900mm wide when open.
 - There shall be no ridges at the joints or anywhere else in the paving surface
 - All external paving materials shall have a non-slip finish

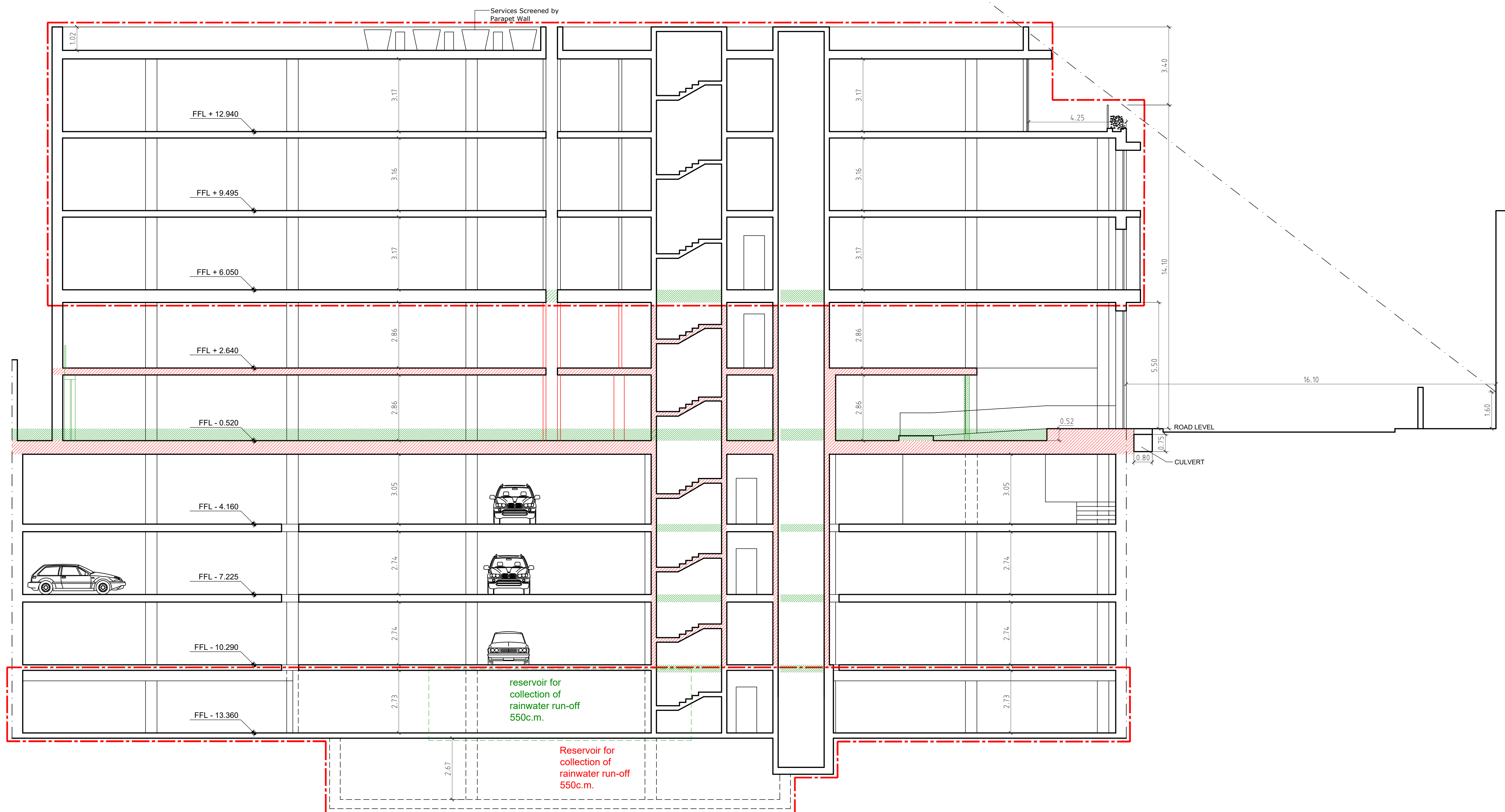

- █ To Construct
- █ To Demolish
- █ Approved but not constructed
- █ As construct to sanction

Project: Amended application to PA/00224/14. Works relate to the introduction of an additional basement parking level, internal and external alterations, change of use for part of ground floor level from commercial class 4B use (retail premises) to class 4A (offices), the construction of three additional full floors and one recessed floor.

Drawing Title: Approved vs Proposed Section C-C

Date: 03/01/2019

Scale: As Noted A1

Drawing No.: 012_R04

Drawn By: CC

Checked By: IB

Copyright © Perit Ivan Bondin. All rights reserved. No part may be reproduced, stored in a retrieval system or transmitted in any form or by any means without the prior written permission of the author.

1 PROPOSED VS APPROVED SECTION C-C

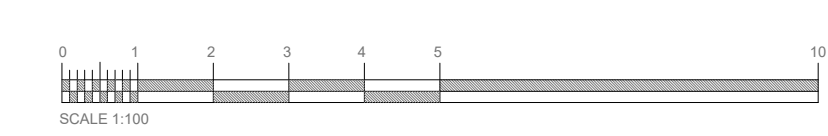

- Drawing Notes:
- All access for all doors shall be min. 900mm wide when open.
 - There shall be no ridges at the joints or anywhere else in the paving surface
 - All external paving materials shall have a non-slip finish

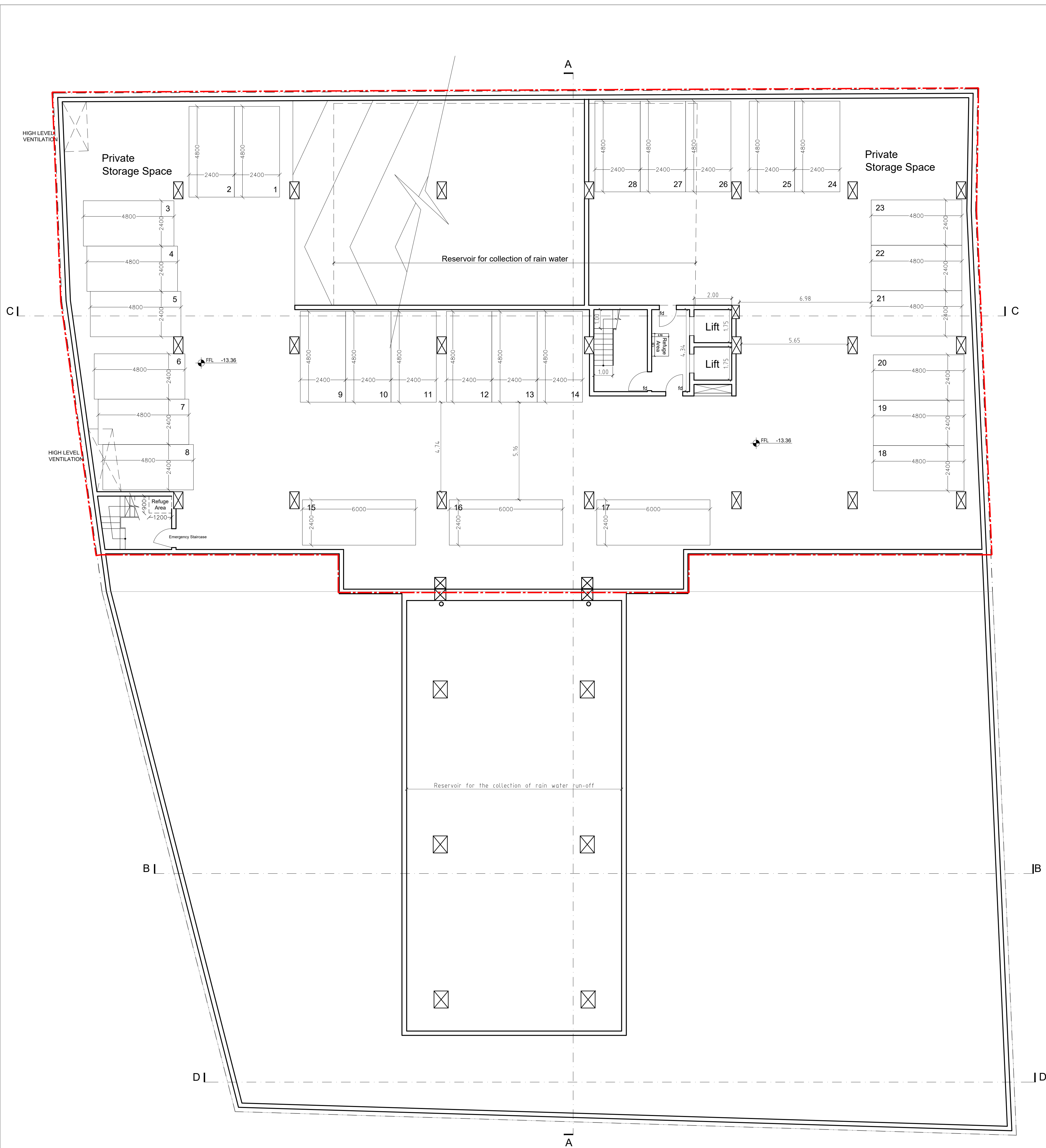

1 PROPOSED LEVEL -4

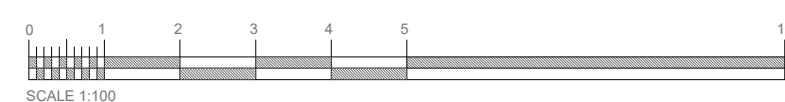

- Drawing Notes:
- All access for all doors shall be min. 900mm wide when open.
 - There shall be no ridges at the joints or anywhere else in the paving surface
 - All external paving materials shall have a non-slip finish



Perit Ivan Bondin

B.E.&A.(Hons.), M.Sc.(Edin.), A.&C.E.

E: info@ibprojects.com.mt

A: Nr.1, Triq Il-Blata l-Kahla, Santa Venera, SVR 1813

A: Nr. 38, Triq ix-Xriek, Mqabba, MQB 1320

T: +356 21498850 / +356 21683147

M: +356 79594078

- To Construct
- To Demolish
- Approved but not constructed
- As construct to sanction

Project: Amended application to PA/00224/14. Works relate to the introduction of an additional basement parking level, internal and external alterations, change of use for part of ground floor level from commercial class 4B use (retail premises) to class 4A (offices), the construction of three additional full floors and one recessed floor.

Drawing Title: Approved vs Proposed Basement Level -4

Date: 03/01/2019

Scale: 1:100 A1

Drawing No.: 014_R07

Drawn By: CC

Checked By: IB

Annex Nr 4 – Summary of Calculation

Plot of Land - Triq il-Palazz I-Ahmar, Mriehel

Key Features:

Gross areas

a Plot area (m²) 1292

Net Areas

a Parking areas 1292 level -4
 b Parking areas 1292 level -3
 c Parking areas 1292 level -2
 d Parking areas 1292 level -1
 e Residential 1292 level 0
 f Residential 1292 Intermediate floor level
 g Residential 1292 1st floor level
 h Residential 1292 2nd floor level
 i Residential 1292 3rd floor level

PA allows:

a) Full Floors 4
 b) Receded Floors 1
 c) Basement 4

| Property Purchase costs | Total |
|--------------------------------|-----------------------|
| Purchase price | € 6,400,000.00 |
| Stamp Duty | € 320,000.00 |
| Notary Fees | € 128,000.00 |
| Total Purchase Price | € 6,848,000.00 |

| PA Development Fees | Unit | Quantity | Rate (€) | Total |
|----------------------------|------|----------|----------|--------------------|
| Total MEPA Fees | | | | € 64,000.00 |

| Construction & Finishes costs | Unit | Quantity | Rate (€) | Total |
|---|----------------|----------|----------|-----------------------|
| Excavation | cm | 14500 | 22 | € 319,000.00 |
| Demolition | L/S | 0 | 0 | € 0.00 |
| Construction all floors | m ² | 11628 | 175 | € 2,034,900.00 |
| Finishes car park | m ² | 5168 | 50 | € 258,400.00 |
| Common Parts incl Lifts | L/S | 1 | 75000 | € 75,000.00 |
| Sub Total | | | | € 2,687,300.00 |
| Contingency at 10% | | | | € 268,730.00 |
| 18% VAT | | | | € 0.00 |
| Cost of Constuction & Finishes | | | | € 2,956,030.00 |

| Professional Fees | Total |
|-----------------------------|--------------------|
| Percentage based | € 82,386.50 |
| 18% VAT | € 14,829.57 |
| Total Architect Fees | € 97,216.07 |

| | |
|---|-----------------------|
| Total Cost of Constuction & Finishes | € 3,053,246.07 |
|---|-----------------------|

| Market Value of Development | Area | Fruitful Units | Unit Value | Estimated resale value |
|------------------------------------|------|----------------|------------|------------------------|
| Total Market Value | | | | € 14,000,000.00 |
| Estate Agency Fees @ 5.9% | | | | € 826,000.00 |
| Tax | | | | € 1,120,000.00 |
| Total Resale Value | | | | € 12,054,000.00 |

| Profits | Total |
|---|-----------------|
| Total project cost | € 9,965,246.07 |
| Total resale value (net of sales commissions) | € 12,054,000.00 |
| Profits | € 2,088,753.93 |
| % Profit as a percentage of capital investment | 20.96% |

Annex Nr 5 – Hypothecs

Nota għall Iskrizzjoni ta' Ipoteka u Privilegg Numru Progressiv 14886

Rimarki
(għall usu
Ufficjali Biss)

**Kreditur: HSBC Bank Malta p.Lc. bin-numru ta' registrazzjoni ittra "C" -
flieta wiehed sebgha sebgha (C-3177).**

**Debituri: Project Technik Limited, bin-numru ta' registrazzjoni ittra "C" - erbgha
tmienja sitta sitta tmienja (C-48668), bl-ufficcju registrar fi Project Technik, Canon
Road, Qormi - Debitrici Principali u Kurt Philip Abela, direttur ta' kumpanija bin
Paul Abela u Maryanne Abela nee' Chircop, imwieded Pieta' fl-erbatax (14) il-gurnata
ta' Lulju tas-sena elf disa' mija u wiehed u tmenin (1981) u residenti T numru sebgha
(7) ittra B appartement numru erbatax (14), il-Ponta ta' Tighe, tas-Sliema, u li għandu
l-karta' ta' l-identita' bin-numru; 428881(M) - Garanti - flimkien u solidalment mad-
Debitrici Principali.**

**Kreditu: Is-somma ta' disa' mija u hamsa u erbghin elf u seba' mitt Ewro
(Ewr945,700) mislufa b'att tiegħi tal-wiehed u ghoxrin (21) gurnata ta' Lulju tas-sena
elfejn u erbatax (2014), minn liema somma mislufa, s-somma ta' tmien mija u wiehed
u ghoxrin elf Ewro (Ewr821,000) giet imhallsa fuq l-att relattiv mill-kreditur kif
delegat mid-debitrici principali lill-venditrici fuq l-att, għall-pjenu saldu tal-prezz tal-
bejgh tal-proprjeta' trasferita fl-att, hawn aktar l-isfel ahjar deskritta. Waqt li r-
rimanenti somma ta' mija u erbgha u ghoxrin elf u seba' mitt Ewro (Ewr124,700)
għandha sservi għall-bzonnijiet ta' negozju tad-debitrici principali *Thomp* / 922-67**

**Kawza ta' Preferenza: Ipoteka Generali għall intier self ta' Ewr945,700, fuq il-
proprjeta' kollha tad-Debitrici Principali u tal-Garanti. Ipoteka Speċjali għall
intier self ta' Ewr945,700 u Privilegg Speċjali għas-somma ta' Ewr821,000, li d-
Debitrici Principali ikkostitwixxiet fuq: L-porzjoni diviza ta' art fabrikabbli, li
kienet tifforma parti mill-għalqa maghrufa bhala "Tal-Palazz l-Ahmar", tal-kejl din
il-porzjoni diviza ta' art, is-soggett ta' dan il-bejgh, ta' cirka elf mitejn u sitta u
disghin metru kwadru (1,296m.k), liema porzjoni diviza ta' art hija mmarkata bl-
ahmar fuq il-"land registry site plan" annessa mal-att u hemm mmarkata bhala
dokument ittra "C". Konfinanti mit-Tramuntana, fejn għandha l-faccata tagħha din
il-porzjoni diviza ta' art, liema faccata hija twila sitta u ghoxrin metru punt tmienja
(26.8m) ma' Triq il-Palazz L-Ahmar, mill-Punent ma' porzjoni diviza oħra mill-istess
għalqa maghrufa bhala "Tal-Palazz L-Ahmar", beni ta' Giorgia Zarb, jew tas-
successuri tagħha fit-titolu, mill-Lvant ma' porzjoni diviza oħra mill-istess għalqa
maghrufa bhala "Tal-Palazz l-Ahmar", beni tal-kumpanija K.A. Holdings Limited,
jew tas-successuri tagħha fit-titolu, u minn nofs-in-nhar ma' raba ta' terzi. Accessibbli
din il-porzjoni diviza ta' art direttament minn Triq il-Palazz l-Ahmar f'Hal-Qormi,
limiti ta' Santa Venera, gieli indikata bhala z-Zona Industrijali tal-Imriehel, limiti ta'
Hal-Qormi jew limiti ta' Santa Venera. Liema porzjoni diviza ta' art hija libera u
franka, libera minn caus u pizijiet, hielsa minn kull servitu', kemm attivi u passivi, u
minn kull dritt rejali u/jew personali favur terzi, tgawdi d-drittijiet u l-pertinenzi kollha
tagħha, inkluz l-arja relattiva u s-sottosuol relattiv, u hija ukoll hielsa minn qbiela u
gabilotti, inkluz kwalunkwe benefikati magħmula fuq l-istess proprjeta'.**

M
Nun ta 2014
Direttur
17 SEP 2014
Pena tal-Persuna li tapplika
għall-Iskrizzjoni.
Not. Dr. Kristel-Elena Chircop, L.L.D.
[Signature]

14886

Nota għall Iskrizzjoni ta' Ipoteka u Privilegg

Numru Progressiv

Rimarki
(għall usu
Ufficjali Biss)

Kreditur:

Debituri:

Kreditu: Il-partijiet jistehmu illi fuq is-somma mislufa għandhom jiddekorru l-imghaxijiet b'rati ta' mhux oghla minn dawk li tippermetti l-Ligi, dawn l-imghaxijiet għandhom ikunu ikkalkolati fuq l-ammont dovut fuq bilanc tas-self mid-debitrici principali minn zmien għal zmien in konformi mal-prattika bankarja. Il-Bank jirriserva a favur tiegħu d-dritt li jimponi dawk il-kondizzjonijiet li jidhirlu ragonevoli għali-hlas lura tal-istess self, u l-interessi li jiddekorru fuqu, fuq perijodu liema kundizzjonijiet (inkluz ir-rata tal-imghax) jistgħu jinbiddu għal ragunijiet ta' sigurta' jew/u għal ragunijiet legali, jew/u regolatorji jew/u jekk ikun hemm tibdil fil-kundizzjonijiet tas-suq. Kull tibdil fil-kundizzjonijiet jigu notifikati lid-debitrici principali fi zmien ragonevoli qabel ma jigu fis-sehh. Is-self huwa għal zmien stipulat. Jekk pero' jkun hemm Ksur ta' l-Obbligi imsemmija fl-att, il-bank jista' jiddikjara billi javza lid-debitrici principali bil-miktub, li s-self huwa dovut u pagabbli minnufih flimkien mal-imghaxijiet u l-ispejjez relattivi, il-Bank ikun jista' jinforza kull dritt li jappartjeni lilu għal hlas lura tas-self u kull garanzija a favur il-Bank tigi fis-sehh. Id-debitrici principali tittef kull beneficcju taz-zmien mogħti lilha għal hlas tas-self u l-imghax relattiv u dan isehh mingħajr ebda proceduri ohra.

Kawza ta' Preferenza:

Illum ta' 2014



17 SEP 2014
Direktur

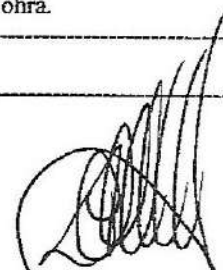

Firma tal-Persuna li tappika
għall-Iskrizzjoni.
Not. Dr. Kristel Elena Chircop, L.L.P.

Nota għall Iskrizzjoni ta' Ipoteka u Privilegg

Numru Progressiv

14889

Rimarki
(għall usu
Ufficjali Biss)

Kreditur: HSBC Bank Malta p.l.c. bin-numru ta' registrazzjoni ittra "C" - tlieta wiehed sebgha sebgha (C-3177).

Debituri: Project Technik Limited, bin-numru ta' registrazzjoni ittra "C" - erbgha tmienja sitta sitta tmienja (C-48668), bl-ufficju registrat fi Project Technik, Canon Road, Qormi - **Debitrici Principali** u Kurt Philip Abela, direttur ta' kumpanija, bin Paul Abela u Maryanne Abela nee' Chircop, imwieled Pieta' fl-erbatax (14) il-gurnata ta' Lulju tas-sena elf disa' mija u wiehed u tmenin (1981) u residenti T numru sebgha (7) ittra B appartament numru erbatax (14), il-Ponta ta' Tigne, tas-Sliema, u li għandu l-karta' ta' l-identita' bin-numru; 428881(M) - **Garanti** - flimkien u solidament mad-Debitrici Principali.

Kreditu: Estensjoni tal-facilitajiet ta' overdraft fuq il-kont/kontijiet kurrenti tad-debitrici principali mal-Bank, permezz ta' att fl-atti tiegħi tal-wiehed u ghoxrin (21) gurnata ta' Lulju tas-sena elfejn u erbatax (2014), u dan b'ammont addizzjonali ta' mitejn u erbgha u hamsin elf u hames mitt Ewro (Ewr254,500), suggett li l-ammont ta' debitu attwali jew kontingenti, mid-debitrici principali favur il-kreditur, qatt ma għandu jeccedi s-somma globali ta' erba mija u wiehed u tmenin elf Ewro (Ewr481,000), u dan inkluz l-ammont ta' l-overdraft originali ta' mitejn u sitta u ghoxrin elf u hames mitt Ewro (Ewr226,500) li kien giet mogħti mill-kreditur lid-debitrici principali, permezz ta' att iehor fl-atti tan-Nutar Dottor Clyde La Rosa tas-sittax (16) il-gurnata ta' Novembru tas-sena elfejn u ghaxxa (2010), liema facilitajiet ta' overdraft kienu gew debitament iskritti fir-registru pubbliku ta' Malta permezz tan-nota ta' ipoteka bin-numru progressiv; *Tkompli* /

Kawza ta' Preferenza: Ipoteka Generali ghas-somma ta' Ewr254,500, li d-Debitrici Principali ikkostitwixxiet fuq il-proprjeta' kollha tagħha. Ipoteka Speċjali ghas-somma ta' Ewr481,000 li d-Debitrici Principali ikkostitwixxiet fuq; L-porzjoni diviza ta' art fabbrikabli, li kienet tiffirma parti mill-għalqa magħrufa bhala "Tal-Palazz l-Ahmar", tal-kejl din il-porzjoni diviza ta' art, is-soggett ta' dan il-bejgħ, ta' cirka elf mitejn u sitta u disghin metru kwadru (1,296m.k), liema porzjoni diviza ta' art hija mmarkata bi-ahmar fuq il-"land registry site plan" annessa mal-att u hemm mmarkata bhala dokument ittra "C". Konfinanti mit-Tramuntana, fejn għandha l-faccata tagħha din il-porzjoni diviza ta' art, liema faccata hija twila sitta u ghoxrin metru punt tmienja (26.8m) ma' Triq il-Palazz L-Ahmar, mill-Punent ma' porzjoni diviza oħra mill-istess għalqa magħrufa bhala "Tal-Palazz L-Ahmar", beni ta' Giorgia Zarb, jew tas-successuri tagħha fit-titolu, mill-Lvant ma' porzjoni diviza oħra mill-istess għalqa magħrufa bhala "Tal-Palazz l-Ahmar", beni tal-kumpanija K.A. Holdings Limited, jew tas-successuri tagħha fit-titolu, u minn nofs-in-nhar ma' raba ta' terzi. Accessibbli din il-porzjoni diviza ta' art direttament minn Triq il-Palazz l-Ahmar f'Hal-Qormi, limiti ta' Santa Venera, għali indikata bhala z-Zona Industrijali tal-Imriehel, limiti ta' Hal-Qormi jew limiti ta' Santa Venera. Liema porzjoni diviza ta' art hija libera u franka, libera minn cnus u pizijiet, hielsa minn kull servitu', kemm attivi u passivi, u minn kull dritt rejali u/jew personali favur terzi, tgawdi d-drittijiet u l-pertinenzi kollha tagħha, inkluz l-arja relattiva u s-sottosuol relattiv, u hija ukoll hielsa minn qbiela u gabilotti, inkluz kwalunkwe benefikati magħmula fuq l-istess proprjeta'. Oltre Ipoteka Generali ghas-somma ta' Ewr481,000, li l-Garanti ikkostitwixxa fuq il-proprjeta' kollha tiegħu.

Not. Dr. Kristel-Elena Chircop, LL.D

17 SEP 2014

Nota għall Iskrizzjoni ta' Ipoteka u Privilegg

Numru Progressiv

14889

Rimarki
(għall usu
Ufficjali Biss)

Kreditur:**Debituri:**

Kreditu: sbatax il-elf hames mija u sebgha u hamsin tas-sena elfejn u ghaxra (I.17,557/2010), liema nota ta' ipoteka kienet giet ssusseggwentament emendata fir-registru pubbliku ta' Malta bin-nota ta' ipoteka bin-numru progressiv; erba' mija u dsatax tas-sena elfejn u hdax (I.419/2011). Gie miftiehem illi l-indikazzjoni tas-somma ta' mitejn u erbgha u hamsin elf u hames mitt Ewro (Ewr254,500) bhala limitu addizzjonali fuq l-att tieghi, tal-wiehed u ghoxrin (21) gurnata ta' Lulju tas-sena elfejn u erbatax (2014), u erba' mija u wiehed u tmenin elf Ewro (Ewr481,000), bhala limitu globali, ma' ghandu bl-ebda mod jigi interpretat bhala obligazzjoni minn-naha tal-Bank, sabiex ihalli l-Klijenta teccedi l-kont/kontijiet taghhom sa tali ammont jew ta' xi kwalunkwe dritt minn-naha tal-Klijenta għall-facilijiet bankarji sa dak l-ammont; imma ghandu jigi meqjus illi l-ammont totali li l-Klijenta tista tkun mdejna mal-Bank ghandu jkun f'kull hin, fid-diskrezzjoni assoluta ta' l-istess Bank. Il-partijiet ftehm u fuq is-somma mislufa, ghandhom jiddekorru l-imghaxijiet, b'rati ta' mhux oghla minn dawk li tippermetti l-Ligi, dawn l-imghaxijiet ghandhom ikunu ikkalkolati fuq il-bilanc tad-debitu minn jum ghal jum, in konformi mal-prattika bankarja. Il-Bank irriserva a favur tieghu, id-dritt li jimponi dawk il-kundizzjonijiet, li jidhirlu ragjonevoli għall-blas lura ta' l-istess self, u l-interessi li jiddekorru fuqu, fuq perjodu, liema kundizzjonijiet (*inkluż ic-charges u r-rata ta' l-imghax*) jistghu jinbidu għal ragunijiet ta' sigurta, jew/u għal ragunijiet legali, jew/u regolatorji, jew/u jekk ikun hemm tibdil fil-kundizzjonijiet tas-suq. Kull tibdil fil-kundizzjonijiet jigu notifikati lill-Klijenta fi zmien ragjonevoli qabel ma' jigu fis-sehh. L-obbligi tal-Klijenta u/jew tal-Garanti fuq dana l-att, huma, u ghandhom ikomplu, jkunu kontinwi, u ghandhom jibqghu isehhu, ghaz zmien kollu li-Klijenta jkollha kont jew kontijiet mal-Bank ma' kwalunkwe wahda mill-ferghat tieghu, u sa tali zmien li l-imsemmija ipoteki jigu kkancellati, minkejja li tali kont (*jew kontijiet*), ikollu bilanc ta' kreditu jew ma jkunx jintuza (*dormant*) għal kwalunkwe perjodu ta' zmien.

Kawza ta' Preferenza:

Illum ta' 2014

17 SEP 2014

Direttur

Firma tal-Persuna li tapplika
għall-Iskrizzjoni.
Not. Dr. Kristel-Elena Chircop, LL.D

021572

Nota ghall Iskrizzjoni ta' Ipoteka

Numru Progressiv

Rimarki
(ghall usu
Ufficjali Biss)

Kreditur: HSBC Bank Malta p.l.c. bin-numru ta' registrazzjoni ittra "C" -
tlieta wiehed sebgha sebgha (C-3177).

Debituri: Project Technik Limited, bin-numru ta' registrazzjoni ittra "C" - erbgha
tmienja sitta sitta tmienja (C-48668), bl-ufficju registrat fi Project Technik, Canon
Road, Qormi - Debitrici Principali u Kurt Philip Abela, direttur ta' kumpanija, bin
Paul Abela u Maryanne Abela nee' Chircop, imwieled Pieta' fl-erbatax (14) il-gurnata
ta' Lulju tas-sena elf disa' mija u wiehed u tmenin (1981) u residenti T numru sebgha
(7) ittra B appartement numru erbatax (14), il-Ponta ta' Tigne, tas-Sliema, u li ghandu
l-karta ta' l-identita' bin-numru; 428881(M) - Garanti - flimkien u solidament mad-
Debitrici Principali.

Kreditu: Facilitajiet ta' "overdraft u/jew general banking facilities li jinkludu ukoll
structured trade finance facilities", fuq il-kont/kontijiet tad-debitrici principali, suggestt
li l-ammont ta' debitu attwali jew kontingenti, mid-debitrici principali, qatt ma ghandu
jeccedi s-somma ta' miljun Ewro (Ewrl,000,000), u dan l-permezz ta' att fl-atti tieghi
tar-raba' (4) gurnata ta' Novembru tas-sena kurrenti elfejn u erbatax (2014), *Tkompli /*

Kawza ta' Preferenza: Ipoteka Generali ghas-somma ta' Ewrl,000,000, li d-Debitrici
Principali ikkostitwixxiet fuq il-proprjeta' kollha taghha. Ipoteka Speccjali ghas-somma
ta' Ewrl,000,000 li d-Debitrici Principali ikkostitwixxiet fuq; L-porzjoni diviza ta' art
fabbrikabbli, li kienet tiffirma parti mill-ghalqa maghrufa bhala "Tal-Palazz L-Ahmar", tal-
kejl din il-porzjoni diviza ta' art, is-soggett ta' dan il-bejgh, ta' cirka elf mitejn u sitta u disghin
metru kwadru (1,296m.k), liema porzjoni diviza ta' art hija mmarkata bi-samar fuq il-"land
registry site plan" annessa ma' att iehor fl-atti tieghi tal-wiehed u ghoxrin (21) gurnata tal-
Lulju tas-sena kurrenti elfejn u erbatax (2014), hemm immarkata bhala dokument ittra "C".
Konfinanti mit-Tramuntana, fejn ghandha l-faccata taghha din il-porzjoni diviza ta' art, liema
faccata hija twila sitta u ghoxrin metru punt tmienja (26.8m) ma' Triq il-Palazz L-Ahmar, mill-
Punent ma' porzjoni diviza ohra mill-istess ghalqa maghrufa bhala "Tal-Palazz L-Ahmar",
beni ta' Giorgia Zarb, jew tas-successuri taghha fit-titolu, mill-Lvant ma' porzjoni diviza ohra
mill-istess ghalqa maghrufa bhala "Tal-Palazz L-Ahmar", beni tal-kumpanija K.A. Holdings
Limited, jew tas-successuri taghha fit-titolu, u minn nofs-in-nhar ma' raba ta' terzi. Accessibbli
din il-porzjoni diviza ta' art direttament minn Triq il-Palazz L-Ahmar f'Hal-Qormi, limiti ta'
Santa Venera, giell indikata bhala z-Zona Industrijali tal-Imrichel, limiti ta' Hal-Qormi jew
limiti ta' Santa Venera. Liema porzjoni diviza ta' art hija libera u franka, libera minn cnus u
pizijiet, hielsa minn kull servitu', kemm attivi u passivi, u minn kull dritt rejali u/jew personali
favur terzi, tgawdi d-drittijiet u l-pertinenzi kollha taghha, inkluz l-arja relattiva u s-sottosuol
relattiv, u hija ukoll hielsa minn qbiela u gabilotti, inkluz kwalunkwe benefikati maghmula fuq
l-istess proprjeta'. Oltre Ipoteka Generali ghas-somma ta' Ewrl,000,000, li l-Garanti
ikkostitwixxa fuq il-proprjeta' kollha tieghu.

Handwritten notes: "978-59" and "800" with scribbles.

Handwritten signature: "CONF" with a large scribble.

Not. Dr. Kristal Elena Chircop, L.L.D

RECEIVED TODAY
29 DEC 2014

Handwritten signature and scribbles.

Nota għall Iskrizzjoni ta' Ipoteka

Numru Progressiv

021572

Rimarki
(għall usu
Ufficjali Biss)

Kreditur:

Debituri:

Kreditu: Gie mitfiehern illi l-indikazzjoni tas-somma ta' miljun Ewro (Ewri1,000,000) bhala limitu, ma' għandu bi-ebda mod jigi interpretat bħala obbligazzjoni minn-naha tal-Bank, sabiex ihalli lid-debitrici principali teccedi l-kont/kontijiet tagħha sa tali ammont jew ta' xi kwalunkwe dritt minn-naha tad-debitrici principali, għall-facilijiet bankarji sa dak l-ammont; imma għandu jigi meqjus illi l-ammont totali li d-debitrici principali tista tkun mdejna mal-Bank għandu jkun f'kull hin, fid-diskrezzjoni assoluta ta' l-istess Bank. Il-partijiet ftehm u illi fuq is-somma mislufa, għandhom jiddekorru l-imghaxijiet, b'rati ta' mhux oghla minn dawk li tippermetti l-Ligi, dawn l-imghaxijiet għandhom ikunu ikkalkolati fuq il-bilanc tad-debitu minn jum għal jum, in konformi mal-prattika bankarja. Il-Bank irriserva a favur tiegħu, id-dritt li jimponi dawk il-kundizzjonijiet, li jidhirlu ragjonevoli għall-hlas lura ta' l-istess self, u l-interessi li jiddekorru fuqu, fuq perjodu, liema kundizzjonijiet (*inkluż ic-charges u r-rata ta' l-imghax*) jistgħu jinbidu għal ragunijiet ta' sigurtà, jew/u għal ragunijiet legali, jew/u regolatorji, jew/u jekk ikun hemm tibdil fil-kundizzjonijiet tas-suq. Kull tibdil fil-kundizzjonijiet jigu notifikati lid-debitrici principali, fi zmien ragjonevoli qabel ma' jigu fis-sehh. L-obbligati tad-debitrici principali u/jew tal-Garanti fuq dana l-att, huma, u għandhom ikomplu, jkunu kontinwi, u għandhom jibqgħu isehhu, għaz zmien kollu li d-debitrici principali jkollha kont jew kontijiet mal-Bank ma' kwalunkwe waħda mill-ferghat tiegħu, u sa tali zmien li l-ipoteki jigu kkancellati, minkejja li tali kont (*jew kontijiet*), ikollu bilanc ta' kreditu jew ma jkunx jintuza (*dormant*) għal kwalunkwe perjodu ta' zmien.

Kawza ta' Preferenza:

Illum ta' 2014

Direttur



Firma tal-Persuna li tapplika
għall-Iskrizzjoni.

Not. Dr. Kristel-Elena Chircop, L.L.D

Nota għali Iskrizzjoni ta' Ipoteka

Numru Progressiv

021573

Rimarki
(għall usu
Ufficjali Biss)

Kreditur: HSBC Bank Malta p.l.c. bin-numru ta' registrazzjoni ittra "C" -
tlieta wiehed sebgha sebgha (C-3177).

Debituri: Project Technik Limited, bin-numru ta' registrazzjoni ittra "C" - erbgha
tmienja sitta sitta tmienja (C-48668), bl-ufficju registrat fi Project Technik, Canon
Road, Qormi - **Debitrici Principali** u Kurt Philip Abela, direttur ta' kumpanja, bin
Paul Abela u Maryanne Abela nee' Chircop, imwield Pieta' fl-erbatax (14) il-gurnata
ta' Lulju tas-sena elf disa' mija u wiehed u imenin (1981) u residenti T numru sebgha
(7) ittra B appartament numru erbatax (14), il-Ponta ta' Tigne, tas-Sliema, u li għandu
l-karta ta' l-identita' bin-numru; 428881(M) - **Garanti** - flimkien u solidament mad-
Debitrici Principali.

Kredits: Estensjoni tal-facilitajiet ta' overdraft fuq il-kont/kontijiet kurrenti tad-
debitrici principali mal-Bank, permezz ta' att fl-atti tiegħi tar-raba' (4) gurnata ta'
Novembru tas-sena kurrenti elfejn u erbatax (2014), u dan b'ammont addizzjonali ta'
mija u erbghin elf Ewro (Ewr140,000), suggett li l-ammont ta' debitu attwali jew
kontingenti, mid-debitrici principali favur il-kreditur, qatt ma għandu jeccedi s-somma
globali ta' sitt mija u wiehed u ghoxrin elf Ewro (Ewr621,000), u dan inkluż l-ammont
ta' l-overdraft originali ta' mitejn u sitta u ghoxrin elf u hames u titt Ewro
(Ewr226,500), hekk kif estiz bis-somma ta' mitejn u erbgha u hamsin elf u hanes mitt
Ewro (Ewr254,500), li kienu gew mogħtija rispettivament mill-kreditur lid-debitrici
principali, permezz ta' (i) att fl-atti tan-Nutar Dottor Clyde La Rosa tas-sittax (16) il-
gurnata ta' Novembru tas-sena elfejn u ghaxra (2010), *Tkompli*

Kawza ta' Preferenza: Ipoteka Generali għas-somma ta' Ewr140,000, li d-Debitrici
Principali ikkostitwixxiet fuq il-proprjeta' kollha tagħha. Ipoteka Speċjali għas-somma
ta' Ewr140,000 li d-Debitrici Principali ikkostitwixxiet fuq, L-porzjoni diviza ta' art
fabbrikabbli, li kienet tiffirma parti mill-ghalqa magħrufa bhala "Tal-Palazz L-Ahmar", ta'
kejl din il-porzjoni diviza ta' art, is-soggett ta' dan il-bejgh, u' cirka elf mitejn u sitta u disghin
metru kwadru (1,296m.k), liema porzjoni diviza ta' art hija mmarkata bl-ahmar fuq il-*land*
registry site plan annessa ma' att iehor fl-atti tiegħi tal-wiehed u ghoxrin (21) gurnata tal-
Lulju tas-sena kurrenti elfejn u erbatax (2014), hemm immarkata bhala dokument ittra "C".
Konfinanti mit-Tramuntana, fejn għandha l-faccata tagħha din il-porzjoni diviza ta' art, liema
faccata hija twila sitta u ghoxrin metru punt tmienja (26.8m) ma' Triq il-Palazz L-Ahmar, mill-
Punent ma' porzjoni diviza oħra mill-istess għalqa magħrufa bhala "Tal-Palazz L-Ahmar",
beni ta' Giorgia Zarb, jew tas-successuri tagħha fit-titolu, mill-Lvant ma' porzjoni diviza oħra
mill-istess għalqa magħrufa bhala "Tal-Palazz L-Ahmar", beni tal-kumpanija K.A. Holdings
Limited, jew tas-successuri tagħha fit-titolu, u minn nofs-in-nhar ma' raba ta' terzi. Accessibbli
din il-porzjoni diviza ta' art direttament minn Triq il-Palazz L-Ahmar f'Hal-Qormi, limiti ta'
Santa Venera, gieli indikata bhala z-Zona Industrijali tal-Imrieħel, limiti ta' Hal-Qormi jew
limiti ta' Santa Venera. Liema porzjoni diviza ta' art hija libera u franka, libera minn enus u
pizizjiet, hielsa minn kull servitu', kemm attivi u passivi, u min kull dritt rejali u/jew personali
favur terzi, tgawdi d-drittijiet u l-pertinenzi kollha tagħha, inkluż l-arja relattiva u s-sottosuol
relattiv, u hija ukoll hielsa minn qbiela u gabilotti, inkluż kwalunkwe benefikati magħmula fuq
l-istess proprjeta'. Oltre Ipoteka Generali għas-somma ta' Ewr140,000, li l-Garanti
ikkostitwixxa fuq il-proprjeta' kollha tiegħu.

Not. Dr. Kristel-Elena Chircop, LL.D

RECEIVED
TODAY
29 DEC 2014

Nota għall Iskrizzjoni ta' Ipoteka

Numru Progressiv 021573

Rimarki
(għall usu
Ufficjali Biss)

Kreditur:

Debituri:

Kreditu: liema facilitata' kienet giet debitament iskritta fir-registru pubbliku ta' Malta permezz tan-nota ta' ipoteka bin-numru progressiv; sbatax il-elf hames mija u sebgha u hamsin tas-sena elfejn u ghaxra (L.17,557/2010), liema nota ta' ipoteka kienet giet ssussewentament emendata fir-registru pubbliku ta' Malta bin-nota ta' ipoteka bin-numru progressiv; erba' mija u dsatax tas-sena elfejn u haxxa (L.1419/2011) u (ii) att fl-atti tiegħi stess tal-wiehed u ghoxrin (21) gurnata ta' Lulju tas-sena kurrenti elfejn u erbatax (2014), liema facilitata' kienet giet debitament iskritta fir-registru pubbliku ta' Malta permezz tan-nota ta' ipoteka bin-numru progressiv; erbatax il-elf tmien mija u disgha u tmenin tas-sena elfejn u erbatax (L.14,389/2014). Gie miftiehem illi l-indikazzjoni tas-somma ta' mija u erbghin elf Ewro (Ewr140,000) bhala limitu addizzjonali fuq l-att tiegħi tar-raba' (4) gurnata ta' Novembru tas-sena kurrenti elfejn u erbatax (2014), u sitt mija u wiehed u ghoxrin elf Ewro (Ewr621,000), bhala limitu globali, ma' ghandu bl-ebda mod jigi interpretat bhala obligazzjoni minn-naha tal-Bank, sabiex ihalli l-Klijenta teccedi l-kont/kontijiet tagħha sa tali ammont jew ta' xi kwalunkwe dritt minn-naha tal-Klijenta għall-facilijiet bankarji sa dak l-ammont; imma ghandu jigi meqjus illi l-ammont totali li l-Klijenta tista tkun indejna mal-Bank ghandu jkun f'kull hin, fid-diskrezzjoni assoluta ta' l-istess Bank. Il-partijiet ftehm u illi fuq is-somma mislufa, għandhom jiddekorru l-imghaxijiet, b'rati ta' mhux oghia minn dawk li tpermetti l-Ligi, dawn l-imghaxijiet għandhom ikunu ikkalkolati fuq il-bilanc tad-debitu minn jum għal jum, in konformi mal-prattika bankarja. Il-Bank irriserva a favur tiegħu, id-dritt li jimponi dawk il-kundizzjonijiet, li jidhirlu ragjonevoli għall-hes lura ta' l-istess self, u l-interessi li jiddekorru fuqu, fuq perjodu, liema kundizzjonijiet (*inkluz ic-charges u r-rata ta' l-imghax*) jistghu jinbidlu għal ragunijiet ta' sigurta, jew/u għal ragunijiet legali, jew/u regolatorji, jew/u jekk ikun hemm tibdil fil-kundizzjonijiet tas-suq. Kull tibdil fil-kundizzjonijiet jigu notifikati lill-Klijenta fi zmien ragjonevoli qabel ma' jigu fis-sehh. L-obbligi tal-Klijenta u/jew tal-Garanti fuq dana l-att, huma, u għandhom ikompli, jkunu kontinwi, u għandhom jibqgħu isehhu, ghaz zmien kollu li-Klijenta jkollha kont jew kontijiet mal-Bank ma' kwalunkwe wahda mill-ferghat tiegħu, u sa tali zmien li l-imsemmija ipoteki jigu kkancellati, minkejja li tali kont (*jew kontijiet*), ikollu bilanc ta' kreditu jew ma jkunx jinstuza (*dormant*) għal kwalunkwe perjodu ta' zmien.

Kawza ta' Preferenza:

Illum ta' 2014

RECEIVED
TODAY
Dinatur 29 DEC 2014

Firma ta' Persuna li tapplika
għall-Iskrizzjoni.
Not. Dr. Kristel-Elena Chircop, LL.D

Att: Mr Kurt Abela

June 17th 2019

KA Holdings Ltd

Project Technik,

Canon Road,

Qormi, QRM 9032

RE: Valuation of a plot of land located in Triq il-Ħawt Swieqi

Introduction

I, the undersigned Architect & Civil Engineer, have been instructed by Mr Kurt Abela (ID: 0428881M), in his capacity as managing director of KA Holdings Ltd., to prepare a valuation report of a plot of land located in Triq il-Ħawt, Swieqi. The valuation report is being prepared in connection with prospective bond issue, to be issued by KA Finance Plc, for which an application will be made for the bonds to be admitted on Prospects MTF, the market regulated as a multilateral trading facility operated by the Malta Stock Exchange.

Basis of Valuation

This valuation report is being prepared in accordance with Chapter 4 of the Prospects MTF Rules (clause 4.13.00). It must be confirmed at the outset that this valuation report is being prepared independently and in line with the guidelines of the UK Royal Institute of Chartered Surveyors. There is no conflict of interest in the advice given in this report apart from the fee associated with the preparation of the same report. The valuation is based on the direct knowledge of the site, the Maltese construction and property markets, the area within which this property is located as well as other information provided to me by KA Holdings and their professional advisers.

For the purpose of this report, the market value is defined as the monetary amount a property is expected to realise when the same property is offered for sale in an open market, for a reasonable period of time, by a willing seller, in order to enable the property to be brought to the attention of potential and willing buyers and when the transaction is not affected by any special circumstance that might affect the buyer, the seller, or the property. The market value is based on the assumption that the buyer and the seller are both acting in their own best interests, have entered into the transaction without any element of compulsion or duress, and the buyer does not have any special relationship or obligation to the seller. Factors that affect the establishment of a market value for a

given property include the condition of the property, the interest held, the nature and conditions prevalent in the market at the date of the valuation, the location, permissible use, size and age.

Site visit and data consulted

The property has been visited on December 14th 2018 in connection with this valuation. For this inspection, I was accompanied by Mr Kurt Abela, in his capacity as managing director of KA Holdings Ltd. In addition to the inspection of the property, the following documentation has also been referred to throughout the preparation of this report;

- Planning Authority Policy Maps (see appendix Nr 1)
- Planning Authority Development Permits related to the same plot of land (see appendix Nr 2)
- Websites of local real estate agencies

The Property

The property in question is located in Triq il-Hawt, Swieqi, in close proximity to Paceville, one of Malta's biggest entertainment and business hubs. In fact, the site is within walking distance from entertainment establishments such as the Eden Cinema, Bowling Arena and St George's Bay. Below is a site plan of the area. The property in question is marked in black.



Figure 1 – Site Plan – Property in question is marked in black

The plot in question has a square area of circa 385.0 square metres and a frontage of circa 4.5 linear metres. Currently, the site is being developed as per Development Permit, PA 08699/17. The site in question is accessed from Triq il-Ħawt that is in turn easily accessible from Swieqi Road via Triq L-Ilqugh.

Planning Considerations

The site is located in an area earmarked from three floors and a semi-basement as indicated on Map SW4 extracted from the North Harbour Local Plan. As per Map SW 2, extracted from the same local plan, the site in question is located in a Residential Priority Area. The planning maps in question are being annexed to this report for ease of reference (see appendix 1). A development permit (PA 08699/17) is already in hand for the development of the site into two levels of open plan parking spaces and garages, the construction of over one thousand square metres of residential space spread between the elevated ground floor level, first floor level, second floor level, third floor level, and a receded floor at fourth floor level. In total, the development will comprise 10 open plan parking spaces, two in number two car garages and one in number one car garage. The ground floor level will have an internal square area of 161.0 square metres and an external square area of 34.0 square metres. The first, second and third floor levels will each comprise an internal square area of 202.0 square metres and an external square area of 20.0 square metres. The receded floor at fourth floor level will have an internal square area of 180.0 square metres and an external square area of 37.0 square metres. A communal pool located in the back yard at elevated ground floor level will also form part of this development. Given the size, location and facilities comprised in the development in question, this development can be safely considered as a high end residential block. The development permit in question, along with the approved drawings are being annexed to this report for ease of reference (see appendix 2).

Works have already commenced on the construction of the lower floors of the building. In fact, at the time of writing of this report, construction works in the formation of the upper basement level were underway (for additional information concerning the current status of the works, the reader is kindly referred to appendix nr 3 wherein a photographic survey is being provided. Construction and finishing works are expected to be complete by the end of 2019 with the first tenants to occupy the facility in summer 2020. It must be stated that at the time of writing of this report, there were no material contraventions on the property in question.

Tenure

The property in question is freehold.

Details of registered mortgages, privileges and other charges

Prospects MTF rule 4.13.04 states that a valuation report is to include details of registered mortgages and privileges as well as other charges. It is understood that there are no mortgages associated with the acquisition of the plot of land forming subject of this valuation report.

Valuation

The valuation for the property was carried out using a combination of two different valuation techniques;

- a. **Comparative Method** – by referring to the databases of local reputable real estate agencies, the market value of the finished residential space and parking spaces have been established. A summary of this estimate is being provided for ease of reference in Appendix Nr 4 at the back of this report. It is being estimated, that in total, the built up and finished properties described above, can reach a total market value of €2,650,000.00
- b. **Residual Method** – Given that the site is in the phase of being developed, the current market value of the site in its current state has been reached using a Residual approach. Once the value of the built up asset has been reached as stated above, expenses associated with the development of the site were factored in. These included construction works, finishing works, architectural fees and Planning Authority fees. The profit for which a potential developer would consider such a venture has also been factored. Once all of the works expenses, fees due, taxation and potential profits have been factored in, the value of the site in question has been established at €835,000.00 (Eight Hundred and Thirty Five Thousand Euro). This value has been reached after taking into consideration that a substantial part of the construction works has already been carried out.

It is therefore being concluded that the site forming subject of this valuation report, in its current state, and as free from any other burden or servitude, has a market value of €835,000.00 (Eight Hundred and Thirty - Five Thousand Euro).

As a final remark, it must be stated that valuations are not a prediction of price, nor a guarantee of value, and whilst my valuation is one which I consider both reasonable and defensible, different valuers may properly arrive at different opinions value. Moreover, the value of property is

susceptible to changes in economic conditions and it may therefore change over relatively short periods of time.



Perit Ivan Bondin

B.E. & A. (Hons), M.Sc (Edin.), A & C.E.

Warrant Nr. 561

Annex Nr 1 – Swieqi Policy Maps

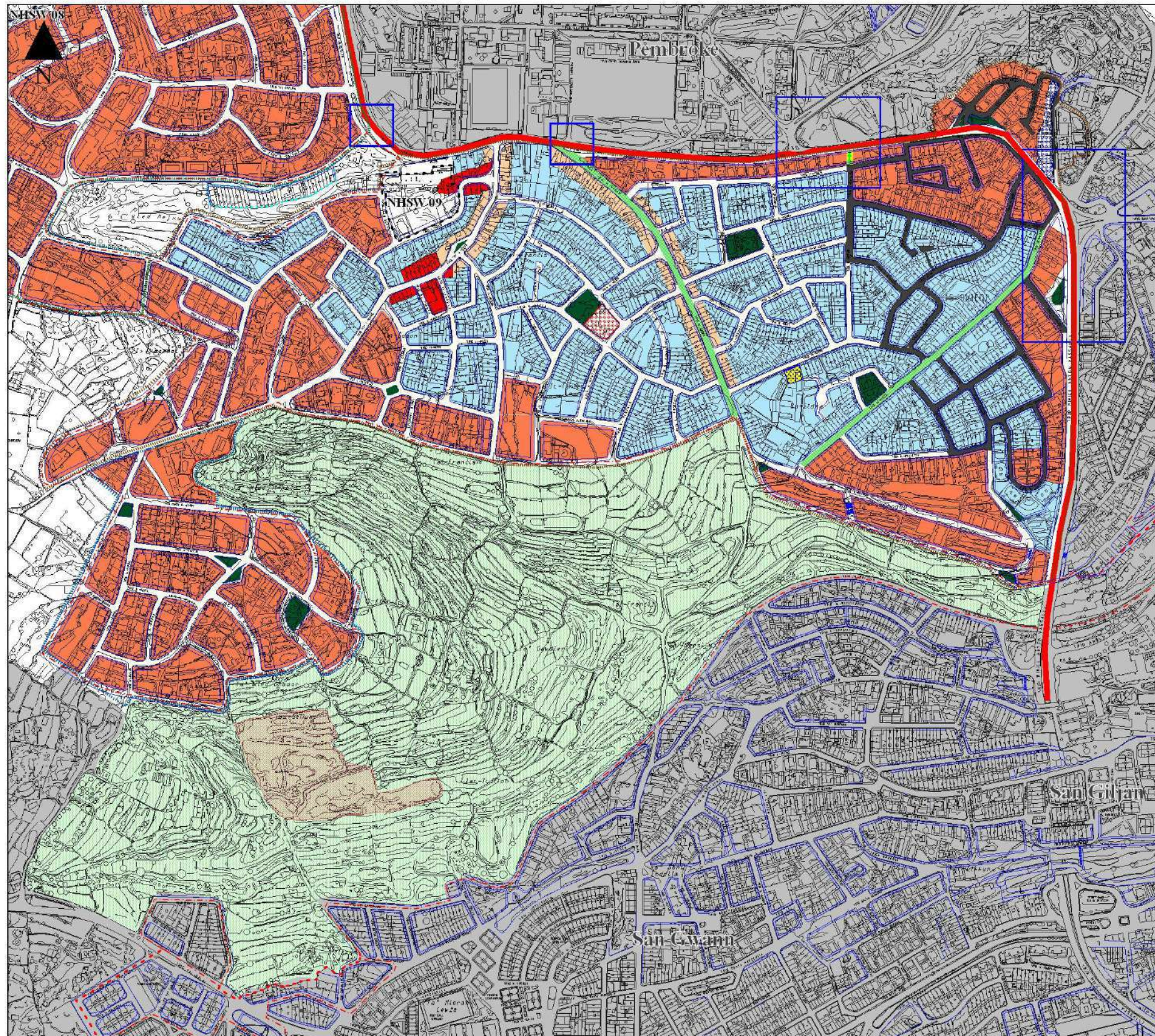

NORTH HARBOURS LOCAL PLAN

MEPA
 AWTORITA' TA' MALTA DWAR L-AMBIENT U L-IPPLANAR
 MALTA ENVIRONMENT & PLANNING AUTHORITY

Key

- Local Centres
NHRE 02, NHSW 01
- Small Local Shops NHSW 01
- Residential Priority Area NHHO 02
(Detached & Semi-Detached Dwellings according to table SW(b))
- Residential Priority Area NHHO 02
(Terraced Houses, Maisonettes & Flats)
- Residential Area NHHO 01
- Residents Parking Zone NHSW 02
- Triq il-Keffa Site NHSW01
- Wied Ghomor Rural Conservation Strategy NHSW06
- Opportunity Site NHSW 08, 09
- Swieqi Road / Qasam Road Environmental Improvement NHSW 03
- Public Open Space NHRL 01
- Arterial Road NHTR 01
- Junction Improvements NHTR 09
- New Link Road NHTR 01
- Extent of existing quarry NHSW 06
- Category 1 Rural Settlement NHSW 07
- Residential Buffer Zone NHSW 10
- Proposed Limit to Development NHSE 01
- Existing Limit to Development (TPS)
- Scheme Alignment

Identity Areas

- Swieqi
- Ibragg
- Madliena

**Swieqi South
 Tal-Ibragg & St. Andrews
 Policy Map**

Scale: **1:6,500** Date: **July 2006** Map: **SW2**

INDICATIVE ONLY
 Not to be used for direct interpretation or for the interpretation of street alignments.

Base Maps - 1988 Survey Sheets (updated)
 Copyright Mapping Unit, Malta Environment & Planning Authority

BPOL/SOUTH090cc

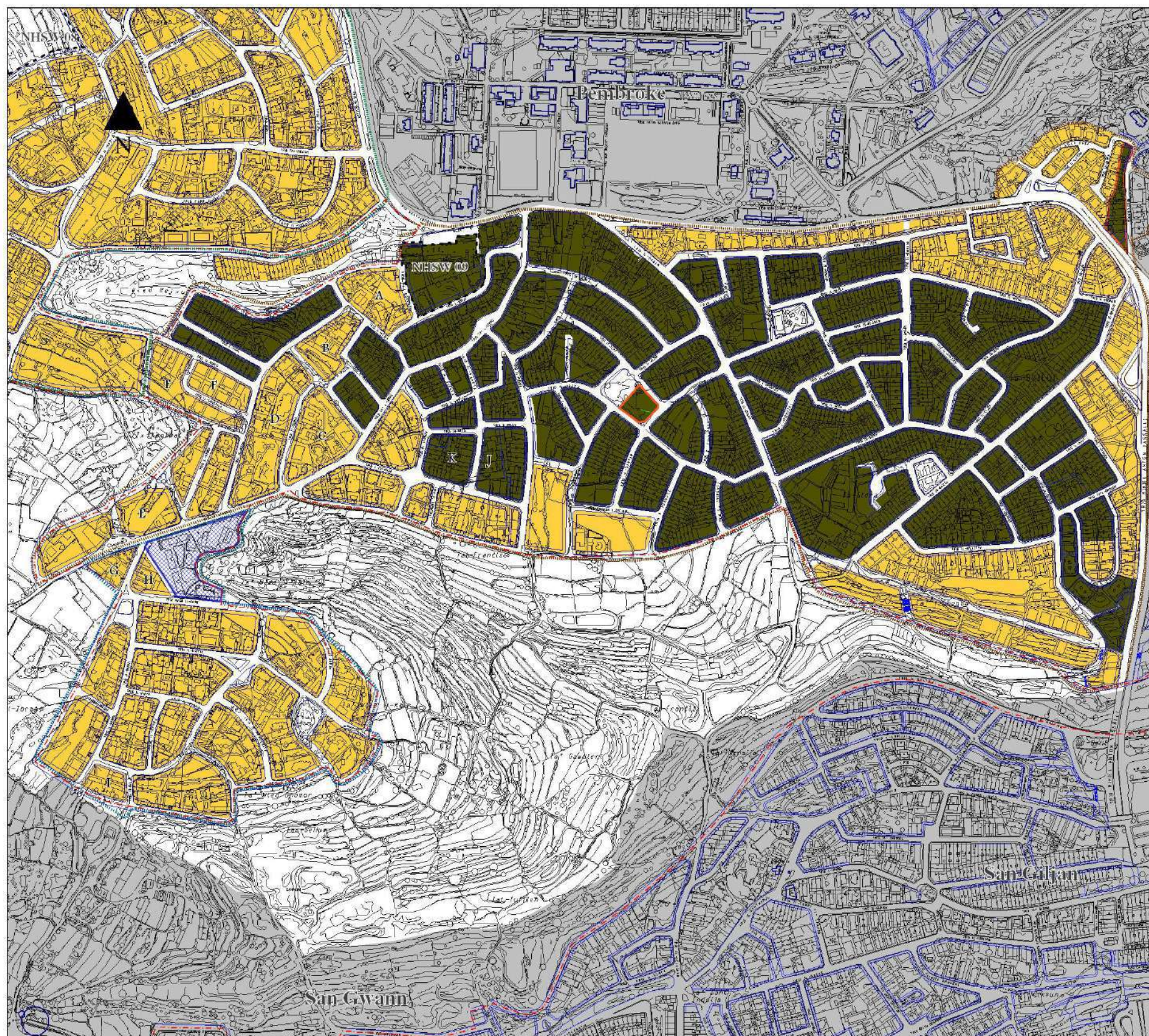

NORTH HARBOURS LOCAL PLAN



AWTORITA' TA' MALTA DWAR L-AMBIENT U L-IPPJANAR
MALTA ENVIRONMENT & PLANNING AUTHORITY

Key

**Building Height Limitations
NHSE 04, NHSW 04**

- 2 Floors with semi-basement
- 3 Floors with semi-basement
- 3 Floors without semi-basement
- To retain the existing building heights
- Opportunity Site NHSW 08, 09
- Madliena Identity Area
- Swieqi Identity Area
- Ta' L-Ibragg Identity Area
- Scheduled Sites/Areas.
Properties of cultural importance may be added in the course of completing the National Protective Inventory of the Maltese Islands, or removed if officially descheduled.
- Proposed Limit to Development NHSE 01
- Existing Limit to Development (TPS)
- Scheme Alignment

N.B. - Refer to Table SW(b) for density designations of blocks A to K

**Swieqi South
(Ta' L-Ibragg & St. Andrews)
Building Heights and Urban Design Map**

| | | |
|---|------------------|------------|
| Scale: | Date: | Map: |
| 1:6000 | July 2006 | SW4 |
| INDICATIVE ONLY Not to be used for direct interpretation or for the interpretation of street alignments. | | |
| Base Maps - 1988 Survey Sheets (Updated) Copyright Mapping Unit, Malta Environment & Planning Authority | | |

65WIEQIBH04cc

Annex Nr 2 – Development Permit and Permit Drawings

Mr. Kurt Abela

Date: 9 March 2018
Our Ref: PA/08699/17

Application Number: PA/08699/17
Application Type: Full development permission
Date Received: 31 August 2017
Approved Documents: PA 8699/17/1B/10A/45B/47C/47D

Supporting document
PA 8699/17/16A (Engineer's report)
PA 8699/17/51A (Environmental health Directorate)

Location: Il-Giardino, Triq Il-Hawt, Swieqi, Malta
Proposal: To demolish upper floors (from GF level upwards) and part of the basement level of an existing building, partially covered by PB5243/89, to carry out alteration works in pre1967 basement structure and to construct two basement levels of garages, communal pool at ground floor, four apartments at ground, first, second and third floor level and receded dwelling at fourth floor level

Development Planning Act, 2016 Full Development Permission

The Planning Authority hereby grants development permission in accordance with the application and documents described above, subject to the following conditions:

- 1 a) This development permission is valid for a period of FIVE YEARS from the date of publication of the decision in the press but will cease to be valid if the development is not completed by the end of this validity period.
- b) This permission relates only to the development as specifically indicated on the approved drawings. This permission does not sanction any other illegal development that may exist on the site.
- c) Copies of all approved drawings and documents shall be available for inspection on site by the Planning Authority officers at all reasonable times.
- d) The development shall be carried out in complete accordance with the approved drawings, documents and conditions of this permission. Where a matter is not specified, then the conditions of this permission and of Development Control Design Policy, Guidance and Standards 2015 shall apply.

e) Before any part of the development hereby permitted commences, the enclosed green copy of this development permission shall be displayed on the site. This must be mounted on a notice board, suitably protected from the weather and located not more than 2 metres above ground level at a point on the site boundary where it is clearly visible and can be easily read from the street. The copy of the permission must be maintained in a good condition and it shall remain displayed on the site until the works are completed.

f) A Commencement Notice is to be submitted to the Planning Authority, by the perit on behalf of the applicant, at least FIVE DAYS prior to the date of commencement of works or utilisation of the permission. Failure to submit the Commencement Notice (with all fields correctly completed) or failure to submit it within the required timeframe shall invalidate the Notice and shall result in the imposition of fines according to Schedule D of Legal Notice 277 of 2012, or its amendments, or its replacements. In addition, **if the applicant fails to submit the Commencement Notice or the Commencement Notice submitted is invalid, the relative permission shall be considered as never having been utilised** - Article 72(4) of the Development Planning Act (2016).

g) All building works shall be erected in accordance with the official alignment and official/existing finished road levels as set out on site by the Planning Authority's Land Surveyor. The Setting Out Request Notice must be submitted to the Land Survey Unit of the Planning Authority when the setting out of the alignment and levels is required.

h) Where an officially schemed street, within the development zone, bordering the site is unopened or unformed, it shall be opened up and brought up to its proper, approved and official formation levels prior to the commencement of any development hereby being permitted.

i) It is the responsibility of the permit holder to ensure that development is carried out in accordance with the provisions of the Environmental Management Construction Site Regulations, Legal Notice 295 of 2007 (or subsequent amendments). Any hoarding shall be erected in accordance with Schedule 2 of the same Regulations.

j) New development on vacant or redeveloped sites shall be provided with a water cistern to store rainwater run-off as required by the Energy Performance of Buildings Regulations (2012) [published through Legal Notice 376 of 2012 and any amendments thereto].

k) No steps, ramps or street furniture are to be constructed on or encroached onto the public pavement or road.

l) Any doors and windows, the lower edge of which is less than 2m above road level, and any gates shall not open outwards onto a public pavement or road.

m) Where present, window grilles (including 'pregnant' windows), sills, planters and other similar elements which are part of or fixed to the facade of buildings, the lower edge of which is less than 2 metres above road level, shall not project more than 0.15 metres from the facade over a public pavement or street.

n) Air conditioning units shall not be located on the facades of the building which are visible from the street or a public space.

o) There shall be no service pipes, cables or wires visible on the front elevation or on any other elevations of the building which are visible from the street or public space.

p) Any garages/parking spaces shall only be used for the parking of private cars and shall

be kept available at all times for this purpose.

- 2
 - a) The façade(s) of the building shall be constructed in local un-rendered and unpainted stone, except where other materials/finishes are indicated on the approved drawings.
 - b) All the apertures and balconies located on the façade(s) of the building shall not be in gold, silver or bronze aluminium.
 - c) Where a front garden is imposed, the 'solid part' of the boundary wall in the front garden shall not be higher than 1.4 metres above the external finished road level. Where the road is sloping, the wall shall be stepped accordingly. Any pillars or gateposts shall not exceed a height of 2.25 metres.
 - d) The height of the services on the roof of the building shall not extend beyond the approved height of the uppermost parapet wall.

- 3 This permission is subject to a Bank Guarantee to the value of **€1138.19** to ensure that the street is properly restored in accordance with the Environmental Management Construction Site Regulations, 2007 (Legal Notice 295 of 2007). The bank guarantee shall only be released after the perit submits a post-construction condition report together with photographs evidencing compliance with this condition, accompanied by clearance from the Local Council. The clearance from the Local Council is to be endorsed by the Mayor and the Executive Secretary of the Local Council. This guarantee shall be forfeited if, after 3 months from the date of notification by the Authority of a notice to effect the remedial works, these are not carried out. Its forfeiture shall not, however, preclude the applicant from adhering to all the conditions contained in this development permission.

- 4 The development hereby permitted shall be subject to Final Compliance (Completion) Certification, verifying that the development has been carried out in full accordance with the approved drawings, documents and conditions imposed in this development permission, except where such conditions are enforced by other entities. Prior to the issue of any compliance certificate on any part of this development, the applicant shall submit to the Planning Authority, in relation to that part of the building:
 - (i) Certification from a qualified engineer confirming that the development fully satisfies the requirements specified in supporting document PA 8699/17/16A.
 - (ii) Certification from a qualified engineer confirming that the approved car lift is installed and operational; that a secondary source of power to the car lift has been provided; and that suitable safety measures such as guardrails and warning signs (both audible and visual) have been installed.

- 5 The conditions imposed and enforced by the Environmental Health Directorate are at supporting document PA8699/17/51A. The architect/applicant is required to contact the Environmental Health Directorate, throughout the implementation of the development hereby approved, to ensure conformity with the imposed conditions. A copy of the relative correspondence / clearance shall be submitted to the Planning Authority accordingly.

6 **Conditions imposed and enforced by other entities**

A. Where construction activity is involved:

(a) the applicant shall:

(i) **Appoint a Project Supervisor for the Design Stage and a Project Supervisor for the Construction Stage** and any such appointment shall be terminated, changed or renewed as necessary. The same person may be appointed to act as project supervisor for both the design and construction stage, if that person is competent to undertake the duties involved and

(ii) **Keep a health and safety file** prepared by the Project Supervisor for the Design Stage.

(b) When the construction works related to this application are scheduled to last longer than thirty working days and on which more than twenty workers are occupied simultaneously, or on which the volume of work is scheduled to exceed five hundred person-days, the project supervisor **shall communicate a prior notice to the Occupational Health and Safety Authority (OHSA) at least four calendar weeks before commencement of works.**

(c) The Project Supervisor for the Design Stage shall **draw up a health and safety plan** which sets out the occupational health and safety rules applicable to the construction activities concerned, outlining the measures to ensure cooperation between different contractors and shall also include specific measures concerning occupational risks that may be present at this site.

B. Where the development concerns a place of work:

The applicant shall:

(i) obtain a Perit's declaration that the necessary requirements arising out of LN 44 of 2002 have been included in the plans and drawings; and

(ii) obtain a Perit's declaration that the building conforms to the requirements of LN 44 of 2002.

C. The development is to strictly adhere to the 'Design Guidelines on fire safety for buildings in Malta' to ensure that all Fire Safety measures and provisions are addressed as indicated in the Design Guidelines on Fire Safety for Buildings in Malta, published by the DCID in 2004, (or other relevant standard, provided it is approved by the Civil Protection Department), Policies, and the Laws and Regulations of Malta.

D. Prior to laying of water and wastewater services in the road, the development shall comply with the requirements of Legal Notice 29/10 Part III (Roads in inhabited Areas) Clause 12.

E. In the event of an accidental discovery in the course of approved works, any cultural heritage feature discovered should not be damaged or disturbed and the Superintendence is to be immediately informed of such discovery. Any cultural heritage features discovered are to be investigated, evaluated and protected in line with the Cultural Heritage Act 2002 (CAP 445). The discovery of cultural heritage features may require the amendment of approved plans.

In terms of Article 72(3) of the Development Planning Act, 2016, the execution and validity of this permission is automatically temporarily **suspended** and no works as approved by the said development permission may commence before the lapse of the time period established in Article 13 of the Environment and Planning Review Tribunal Act and subsequently will remain so suspended if the Tribunal so decides in accordance with the Environment and Planning Review Tribunal Act.

Where the approved drawings and/or documents are dimensioned, then the declared dimensions shall prevail over the actual size as depicted on the approved drawings and/or documents.

Developers are advised to check the invert level to the sewer main with the Water Services Corporation as they would have to make their own arrangements where a gravity service connection is not possible. In these cases, the architect has to indicate the solutions envisaged and to indicate on the plan what needs to be carried out and obtain approval from WSC. Developers are further reminded that connection of storm water into main sewers is not allowed.

If the declaration of ownership, as contained in the application form, is determined as incorrect by a Court of Law, then the said Court of Law can declare this development permission as null and void. This development permission does not remove or replace the need to obtain the consent of the land/building owner to this development before it is carried out. Furthermore, it does not imply that consent will necessarily be forthcoming nor does it bind the land/building owner to agree to this development. Where the land/building is owned or administered by the Government of Malta a specific clearance and agreement must be obtained for this development from the Land and/or Estate Management Departments.

This development permission is granted saving third party rights. This permission does not exonerate the applicant from obtaining any other necessary permission, license, clearance or approval required from any Government department, local council, agency or authority, as required by any law or regulation.

This development permit does not authorise any storage of substances listed in Occupational Health and Safety Authority Act (Cap. 424) - Control of Major Accident Hazards Regulations, 2003, as amended, in quantities that would render this site an establishment within scope of these regulations. The storage and handling of said substances may require a new or amended development permission in line with current policies and regulations.

For any non-residential uses hereby being approved, prior to commencement of any works on site or any eventual permitted change of use, the applicant shall be required to contact the Environment and Resources Authority to obtain any necessary operational permit or registration. This requirement does not apply to Class 2B, 2C, 4A and 4B uses as listed in the Development Planning (Use Classes) Order 2014, or its subsequent amendments.

This decision is being published on 21 March 2018.

Marthese Debono
Secretary Planning Commission (Development Permissions)

Notes to Applicant and Perit

Right for reconsideration

Where applicable, you have a right to submit a request for reconsideration to the Authority in terms of regulation 14 of Legal Notice 162 of 2016.

Right for appeal

You have a right to submit an appeal, against the decision, to the Environment and Planning Review Tribunal in terms of Article 13 of the Environment and Planning Review Tribunal Act, 2016.

Time limits

Requests for reconsideration or appeals must be made within 30 days from the publication of the decision notification in the local press as required by regulation 14(1) of Legal Notice 162 of 2016.

Fees to submit a request for reconsideration or appeal

In either case, there is a fee to be paid which should accompany the request for reconsideration or the appeal. The fees are as follows:

For reconsideration - 3% of the Development Permit Fee paid in respect of the original application, subject to a minimum of €69.88.

For appeal - 5% of DPF (Development Permit Fee) paid in respect of the original application, subject to a minimum of €150 + €50 administrative fee (LN 112 of 2016).

Submission of request for reconsideration or appeal

With regards to requests for reconsideration, Form PA 4/16 must be used for submission. All fields of the Form must be filled in as appropriate. Requests for reconsideration can only be submitted electronically.

With regards to appeals, as required by Article 13 of the Environment and Planning Review Tribunal Act, 2016, the submission must include the detailed grounds for appeal and the requests being made by the appellant. Appeals must be submitted physically at the offices of the Environment and Planning Review Tribunal, St. Francis Ditch, Floriana.

Important Notice

In view of the provisions of Article 72(4) of the Development Planning Act (2016), a Commencement Notice is to be submitted to the Planning Authority, by the perit on behalf of the applicant, at least FIVE DAYS prior to the date of commencement of works or utilisation of the permission. Failure to submit the Commencement Notice (with all fields correctly completed) or failure to submit it within the required timeframe shall invalidate the Notice and shall result in the imposition of fines according to Schedule D of Legal Notice 277 of 2012, or its amendments, or its replacements. In addition, if the applicant fails to submit the Commencement Notice or the Commencement Notice submitted is invalid, the relative permission shall be considered as never having been utilised.

-PADCN-

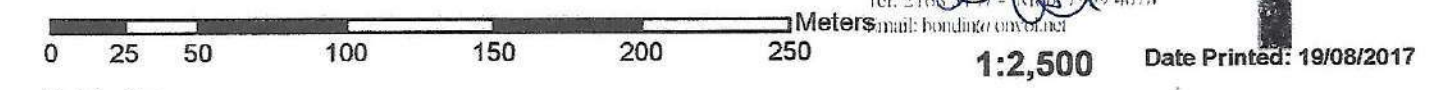
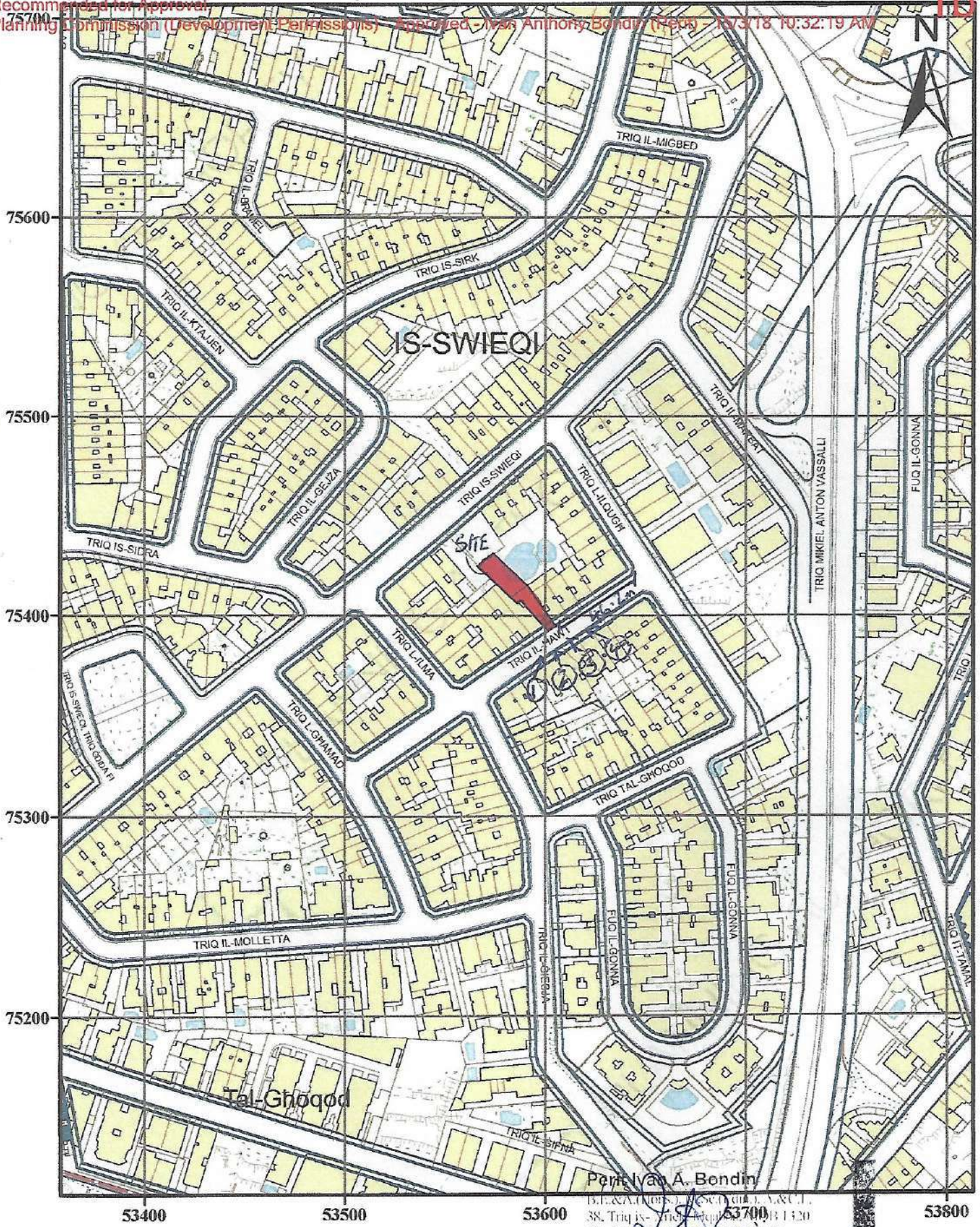

Public Geoserver
Compiled and published by the Mapping Unit, Planning Authority ©PA.
Reproduction in whole or in part by any means is prohibited without the prior permission of the Mapping unit.
Data Captured from: 1988, 1994, 1998, 2004 & 2008 aerial photography and updates from 2012 orthophotos.



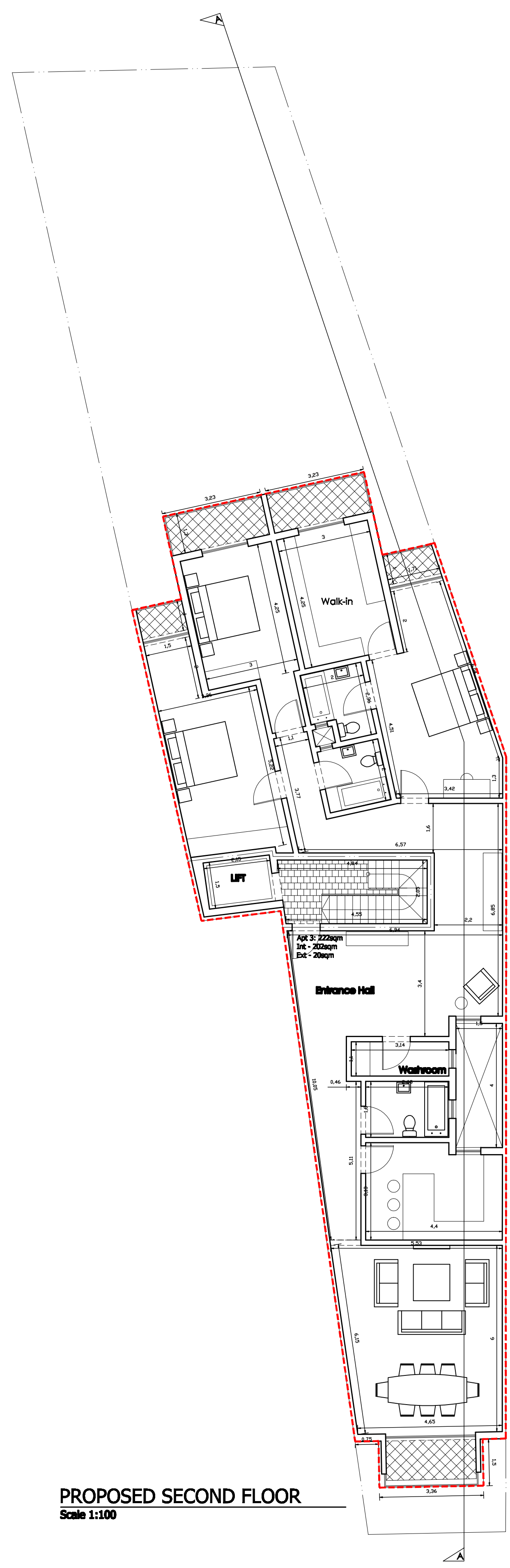

PROPOSED SECOND FLOOR
 Scale 1:100

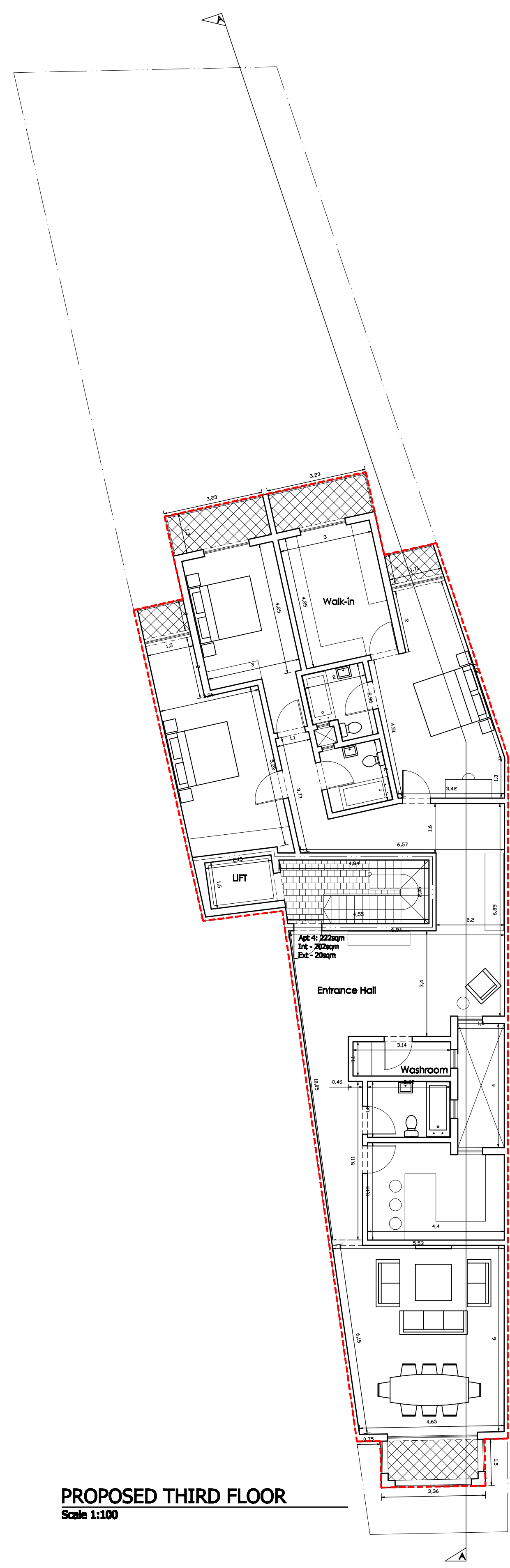

PROPOSED THIRD FLOOR
 Scale 1:100

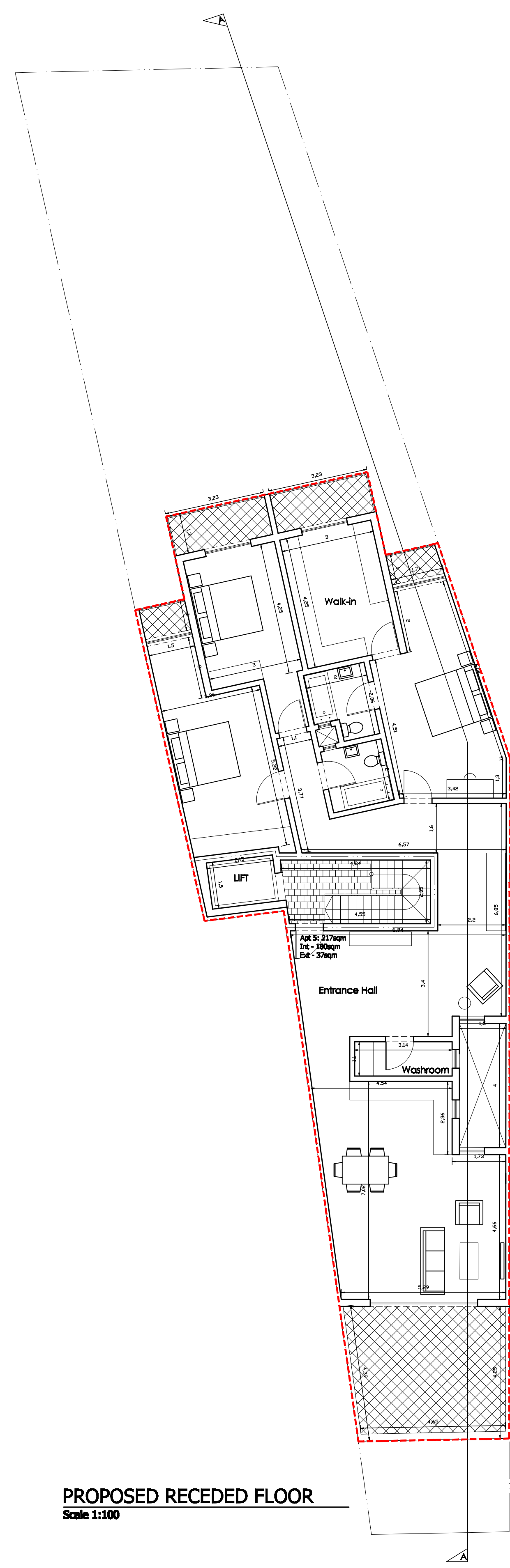

PROPOSED RECEDED FLOOR
 Scale 1:100

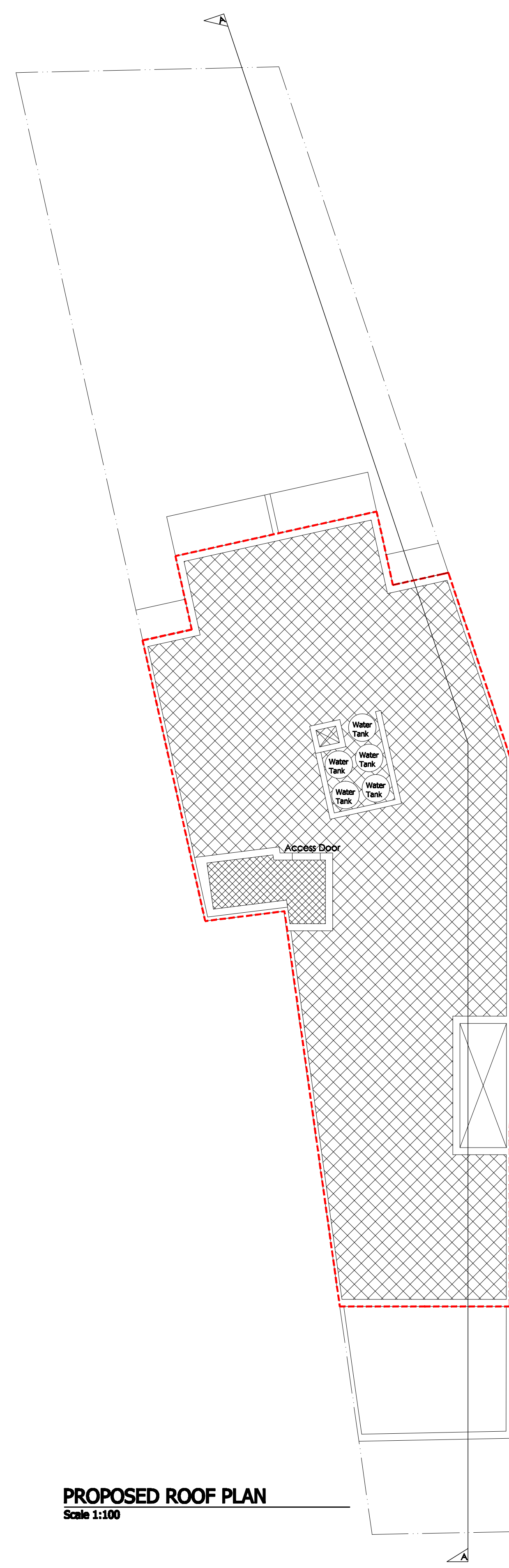

PROPOSED ROOF PLAN
 Scale 1:100

--- To Construct
 --- To Demolish

Perit Ivan A. Bondin

B.E.&A.(Hons.), M.Sc.(Edin.), A.&C.E.
 La Pietra, 36, Triq ix-Xriek, Mgabba, MQB 1320. Tel: 21683147
 Mob: 79594078 Mail: bondin@envol.net

Job Description: To demolish upper floors (from GF level upwards) of existing building partially covered by PBS243/89, to carry out alteration works in pre1967 basement structure and to construct two basement levels of garages communal pool at ground floor, four apartments at ground, first, second & third floor level and receded dwelling at fourth floor level

Title: Proposed Plans
 Location: Il Giardino, Triq Il-Hawt, Swieqi

Scale: 1:100 (A1)
 Drawing Nr. - 03_rev1

Drawn by: BF
 Date: November 17

Notes:

| Revision: | ref | date | by | description | Backyard |
|-----------|-----|------------|----|-------------|----------|
| 01 | 01 | 07/11/2017 | BF | | |
| 00 | 00 | 00/00/2017 | -- | | |

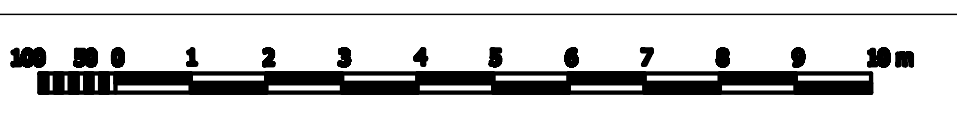

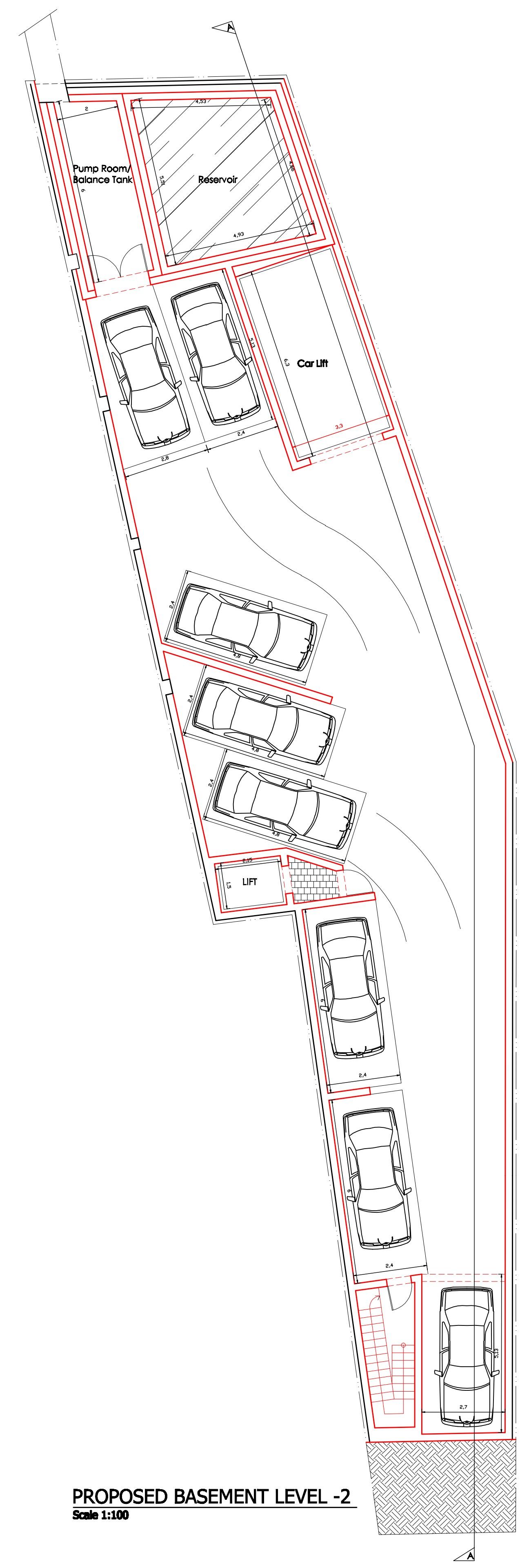

PROPOSED BASEMENT LEVEL -2
 Scale 1:100

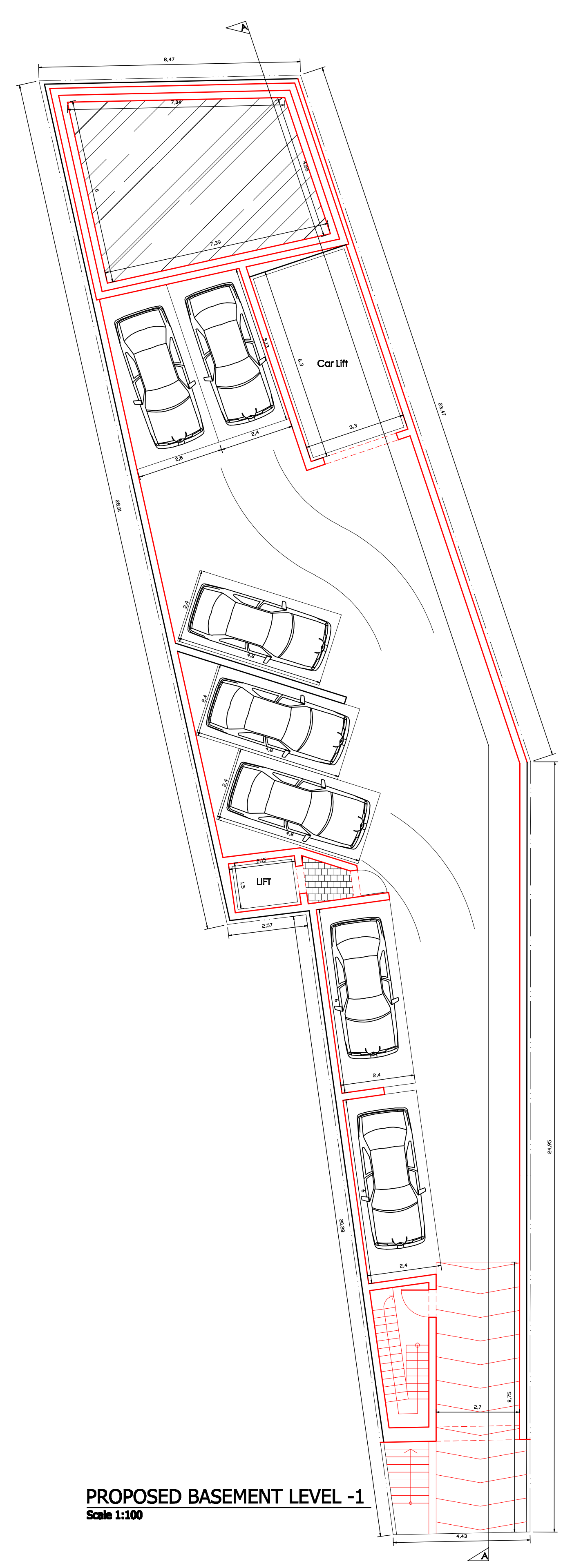

PROPOSED BASEMENT LEVEL -1
 Scale 1:100

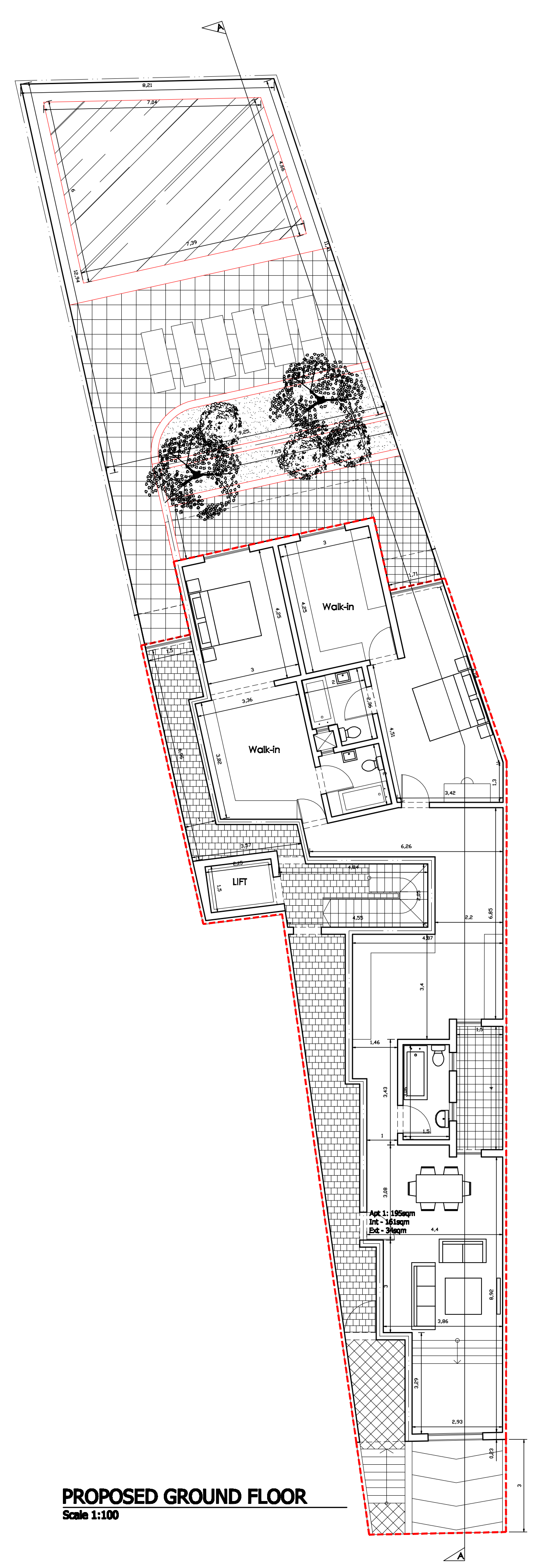

PROPOSED GROUND FLOOR
 Scale 1:100

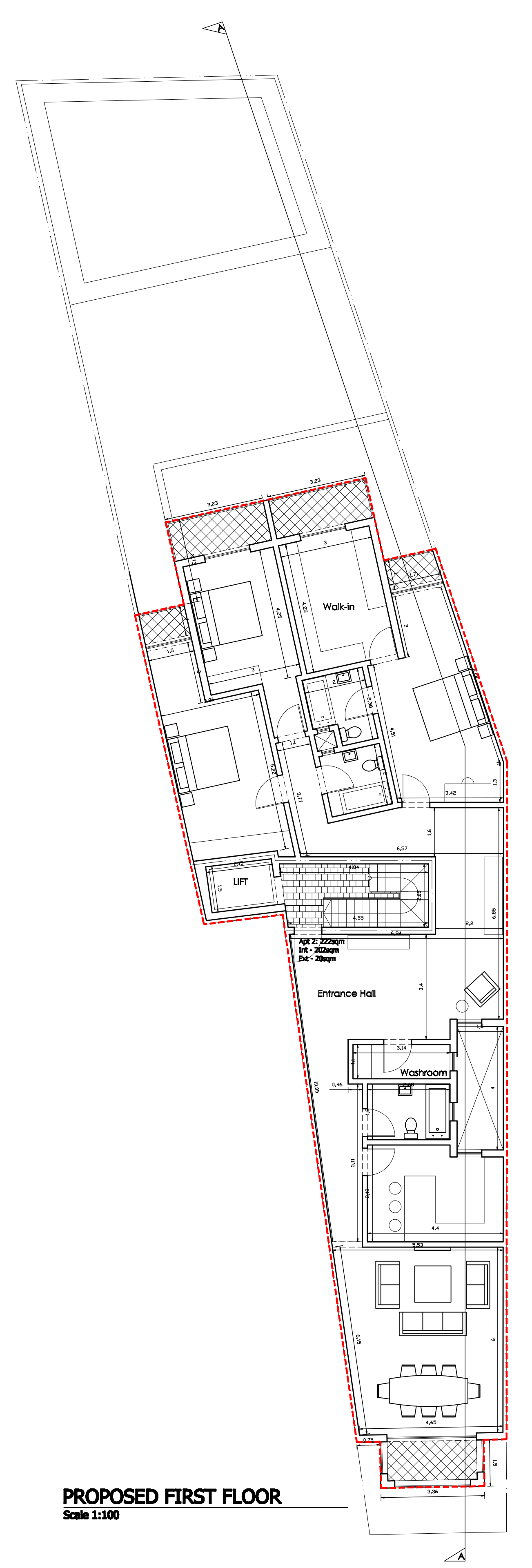

PROPOSED FIRST FLOOR
 Scale 1:100

TRIQ IL-HAWT

TRIQ IL-HAWT

--- To Construct
 --- To Demolish

Perit Ivan A. Bondin

B.E.&A.(Hons.), M.Sc.(Edin.), A.&C.E.
 La Pietra, 36, Triq ix-Xriek, Mgabba, MQB 1320. Tel: 21683147
 Mob: 79594078 Mail: bondin@onvol.net

Job Description: To demolish upper floors (from GF level upwards) of existing building partially covered by PB5243/89, to carry out alteration works in pre1967 basement structure and to construct two basement levels of garages communal pool at ground floor, four apartments at ground, first, second & third floor level and recessed dwelling at fourth floor level

Title: Proposed plans
 Location: Il Giardino, Triq Il-Hawt, Swieqi

Scale: 1:100 (A1)
 Drawing Nr. - 02_rev2

Drawn by: BF
 Date: November 17

Notes:

| Revision: | ref | date | by | description |
|-----------|-----|------------|----|-------------|
| 01 | | 07/11/2017 | BF | Backyard |
| 02 | | 18/11/2017 | BF | Landscaping |

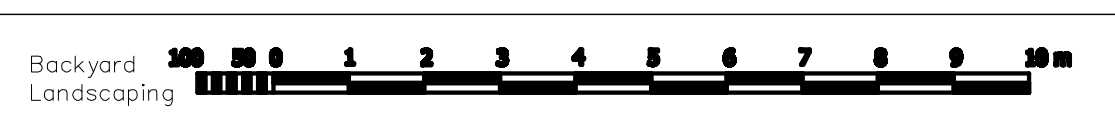

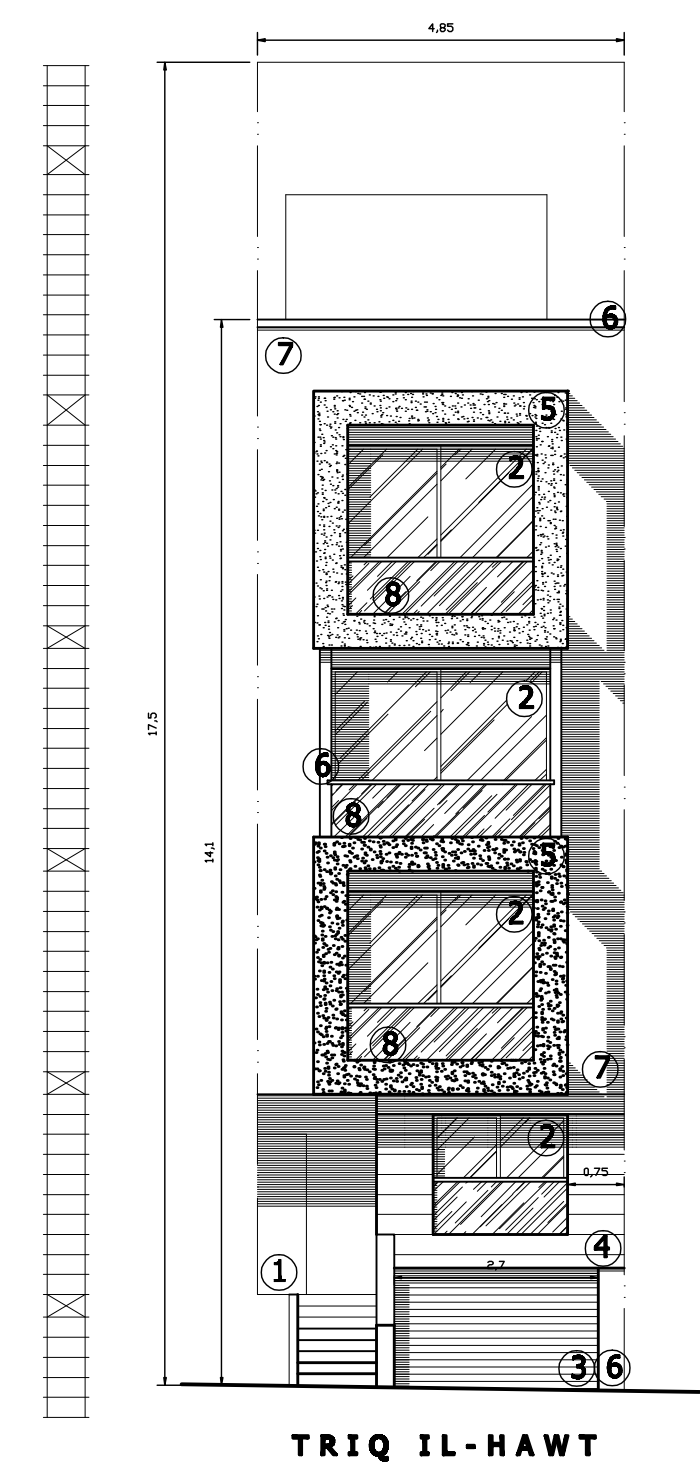
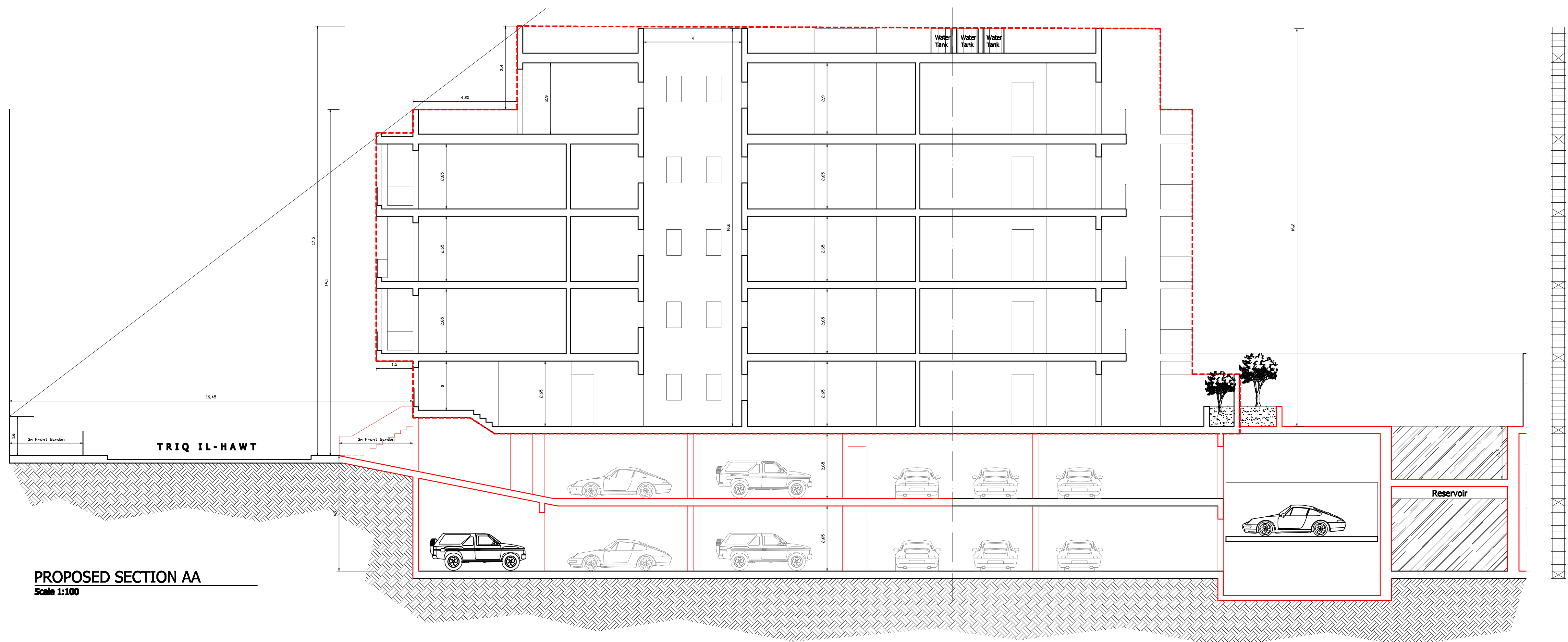

- ① Timber door
- ② Aluminium apertures
- ③ White PVC garage door
- ④ 'Fuq il-Fil' with Imbrol
- ⑤ Dark Grey Plastered walls
- ⑥ Light Grey Plastered walls
- ⑦ White Plastered walls
- ⑧ Glass Railings

--- To Construct
 --- To Demolish

Perit Ivan A. Bondin

B.E.&A.(Hons.), M.Sc.(Edin.), A.&C.E.
 La Pietra, 36, Triq ix-Xriek, Mgabba, MQB 1320. Tel: 21683147
 Mob: 79594078 Mail: bondin@omvol.net

Job Description: To demolish upper floors (from GF level upwards) of existing building partially covered by PBS243/89, to carry out alteration works in pre-1967 basement structure and to construct two basement levels of garages communal pool at ground floor, four apartments at ground, first, second & third floor level and recessed dwelling at fourth floor level

Title: Proposed Elevation & Section AA
 Location: Il Giardino, Triq Il-Hawt, Swieqi

Scale: 1:100 (A1)
 Drawing Nr. - 04_rev2

Drawn by: BF
 Date: November 17

Notes:

| Revision: | ref | date | by | description |
|-----------|------------|------|----------|-------------|
| 01 | 07/11/2017 | BF | Backyard | Landscaping |
| 02 | 18/11/2017 | BF | Backyard | Landscaping |

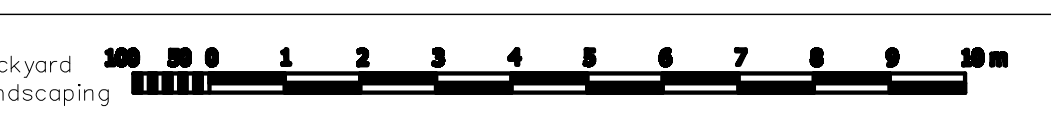

Annex Nr 3 – Photographic Survey



Photo 1



Photo 2



Photo 3



Photo 4

Annex Nr 4 – Summary of Calculation

Feasibility Calculation

K Abela - Triq il Hawt, Swieqi

Key Features:

Gross areas

a) Plot area 295

Net Areas

a) Parking 380 level -1
 b) Parking 380 level -1
 c) Residential 270 level 0
 d) Residential 270 level 1
 e) Residential 270 level 2
 f) Residential 270 level 3
 g) Residential 270 level Penthouse

MEPA allows:

a) Full Floors 4
 b) Receded Floors 1
 c) Basement 2

| | Total |
|-----------------------------|---------------------|
| Purchase price | € 735,000.00 |
| Stamp Duty | € 36,750.00 |
| Notary Fees | € 14,700.00 |
| Total Purchase Price | € 786,450.00 |

| MEPA Fees | Unit | Quantity | Rate (€) | Total |
|------------------------|----------------|----------|----------|--------------------|
| Residential | m ² | 1080 | € 6.12 | € 6,609.60 |
| Residential penthouse | m ² | 270 | € 31.00 | € 8,370.00 |
| Parking contribution | Nr | 0 | € 0.00 | € 0.00 |
| Car park | m ² | 380 | € 10.70 | € 4,066.00 |
| Sub Total | | | | € 19,045.60 |
| Total MEPA Fees | | | | € 19,045.60 |

| Construction & Finishes costs | Unit | Quantity | Rate (€) | Total |
|---|----------------|----------|----------|-----------------------|
| Excavation | cm | 0 | 0 | € 0.00 |
| Demolition | L/S | 1 | 20000 | € 20,000.00 |
| Construction all floors | m ² | 2110 | 175 | € 369,250.00 |
| Finishes car park | m ² | 760 | 25 | € 19,000.00 |
| Finishes residential | m ² | 2110 | 175 | € 369,250.00 |
| Sub Total | | | | € 777,500.00 |
| Contingency at 10% | | | | € 77,750.00 |
| 18% VAT | | | | € 153,945.00 |
| Cost of Constuction & Finishes | | | | € 1,009,195.00 |

| Professional Fees | Total |
|---|--------------------|
| 6% of construction (excluding finishes) | € 23,355.00 |
| 18% VAT | € 4,203.90 |
| Total Architect Fees | € 27,558.90 |

| | |
|---|-----------------------|
| Total Cost of Constuction & Finishes | € 1,055,799.50 |
|---|-----------------------|

| Finance Costs | Total |
|--|-------|
| Finance at 6% for 0-12 months for 400, 000 | |
| Total Finance Costs | |

| Market Value of Development | Unit Value | Estimated resale value |
|-----------------------------|-------------|------------------------|
| Parking Spaces/garages | € 350,000 | € 350,000 |
| Residential | € 2,300,000 | € 2,300,000 |
| Total Market Value | | € 2,650,000.00 |
| Estate Agency Fees @ 5.9% | | € 156,350.00 |
| Tax | | € 212,000.00 |
| Total Resale Value | | € 2,281,650.00 |

| Profits | Total |
|---|----------------|
| Total project cost | € 1,842,249.50 |
| Total resale value (net of sales commissions) | € 2,281,650.00 |
| Profits | € 439,400.50 |
| % Profit as a percentage of capital investment | 23.85% |

Att: Mr Kurt Abela

June 17th 2019

KA Holdings Ltd

Project Technik,

Canon Road,

Qormi, QRM 9032

RE: Valuation of a first floor maisonette located at 43, Sir William Reid Street c/w Triq Carlo Manche, Gżira

Introduction

I, the undersigned Architect & Civil Engineer, have been instructed by Mr Kurt Abela (ID: 0428881M), in his capacity as managing director of KA Holdings Ltd., to prepare a valuation report of a first floor maisonette, and its overlying airspace, located at 43, Sir William Reid Street c/w, Carlo Manche' Street, Gżira. The valuation report is being prepared in connection with prospective bond issue, to be issued by KA Finance plc, for which an application will be made for the bonds to be admitted on Prospects MTF, the market regulated as a multilateral trading facility operated by the Malta Stock Exchange.

Basis of Valuation

This valuation report is being prepared in accordance with Chapter 4 of the Prospects MTF Rules (clause 4.13.00). It must be confirmed at the outset that this valuation report is being prepared independently and in line with the guidelines of the UK Royal Institute of Chartered Surveyors. There is no conflict of interest in the advice given in this report apart from the fee associated with the preparation of the same report. The valuation is based on the direct knowledge of the site, the Maltese construction and property markets, the area within which this property is located as well as other information provided to me by KA Holdings and their professional advisers.

For the purpose of this report, the market value is defined as the monetary amount a property is expected to realise when the same property is offered for sale in an open market, for a reasonable period of time, by a willing seller, in order to enable the property to be brought to the attention of potential and willing buyers and when the transaction is not affected by any special circumstance that might affect the buyer, the seller, or the property. The market value is based on the assumption that the buyer and the seller are both acting in their own best interests, have entered into the

The property consists of an entrance hall, a stairwell, and two rooms at ground floor level. In total, the square area of the ground floor level amounts to circa 37.0 square metres. The stairwell leads to the first floor level where three additional rooms are located. The square area at first floor level is circa 67.0 square metres. The airspace over the first floor level is also part of this property. It must be noted that the property is a pre-1967 structure and no development permits related to it could be traced. Nonetheless, an application for development to convert the existing property into a guesthouse has now been approved. Details of this application are being provided below. Moreover, pictures of the property, in its current state are also being provided in Appendix Nr 1 at the back of this report.

Planning Considerations

The site is located in an area earmarked for 4 floors plus basement as indicated on Map GT2 extracted from the North Harbours Local Plan (see map in question is Appendix Nr 2). As per the Planning Authority Design Guidelines issued in 2015, this means that the site in question can be developed up to a maximum height of 20.80 metres. In keeping with these policies, it is being envisaged, that the existing maisonette is to be converted into a guest house comprising of 8 suites, each of which will be equipped with an ensuite bathroom. A Planning Authority Development Permit (PA 02735/18) to cover such development has been approved on January 29th 2019. All the conditions related to the release of this permit by the Planning Authority have been satisfied and on May 15th 2019, the permit in question has been rendered executable.

The permit in question covers the conversion of the existing ground floor level into a reception and breakfast area, the conversion of the existing first floor level into two bedroom suites, and the construction of six additional bedroom suits spread over the second, third, and fourth floor levels. A communal pool, along with its pool deck and kitchenette, will be located at fifth floor level. The drawings and permit document in question are being annexed to this report for ease of reference (see Appendix Nr 3). Works on this project are expected to commence towards the beginning of summer 2019 and are expected to take circa 8 months. The facility is expected to welcome its first guests in the summer of 2020. It must be pointed out that at the time of writing of this report there were no material contraventions associated with this property.

Tenure

The property in question is freehold.

Details of registered mortgages, privileges and other charges

Prospects MTF rule 4.13.04 states that a valuation report is to include details of registered mortgages and privileges as well as other charges. It is understood that there are no mortgages associated with the acquisition of the maisonette and its overlying airpscae forming subject of this valuation report.

Valuation

The valuation for the property was carried out using a combination of two different valuation techniques;

- a. **Comparative Method** – at the time of writing of this report, a similar guesthouse in Gżira, that has already been built, was being marketed for sale at €690,000.00. This, however, comprised of 11 suites and was being sold in shell form. In the case of KA Holding’s guest house, this will eventually comprise of 8 suites. Using a simple comparative method, the guest house in question, when built in shell form, can thus reach a value of circa €550,000.00.

- b. **Residual Method** – Given that the site in question is in the process of being developed, the current market value of the site in its current state has been reached using a Residual approach method. Once the value of the built up asset, in shell form, has been reached as stated above, expenses associated with the development of the site to shell state were factored in. These included construction works, architectural fees and Planning Authority fees. The profit for which a potential developer would consider such a venture has also been factored in. Once all of the works expenses, fees due, taxation and potential profits have been factored in, the value of the site in question has been established at €280,000.00 (Two Hundred and Eighty Thousand Euro). A summary of the calculation that led to the said value is being annexed to this report for ease of reference (see Appendix Nr 4).

It is therefore being concluded that the site forming subject of this valuation report, in its current state, and as free from any other burden or servitude, has a market value of €280,000.00 (Two Hundred & Eighty Thousand Euro).

As a final remark, it must be stated that valuations are not a prediction of price, nor a guarantee of value, and whilst my valuation is one which I consider both reasonable and defensible, different valuers may properly arrive at different opinions value. Moreover, the value of property is susceptible to changes in economic conditions and it may therefore change over relatively short periods of time.



Perit Ivan Bondin

B.E. & A. (Hons), M.Sc (Edin.), A & C.E.

Warrant Nr. 561

Annex Nr 1 – Photographic Survey

PERIT IVAN A. BONDIN

'La Pieta', No.38, Triq Ix- Xriek, Mqabba - MALTA. , Mob. 79594078, Tel. 21683147, email: bondin@onvol.net



Picture 1

Site in question is marked in red

PERIT IVAN A. BONDIN

'La Pieta', No.38, Triq Ix- Xriek, Mqabba - MALTA. , Mob. 79594078, Tel. 21683147, email: bondin@onvol.net



Picture 2

Site in question is marked in red

PERIT IVAN A. BONDIN

'La Pieta', No.38, Triq Ix- Xriek, Mqabba - MALTA. , Mob. 79594078, Tel. 21683147, email: bondin@onvol.net



Picture 3

Site in question is marked in red

Annex Nr 2 – Gżira Policy Maps

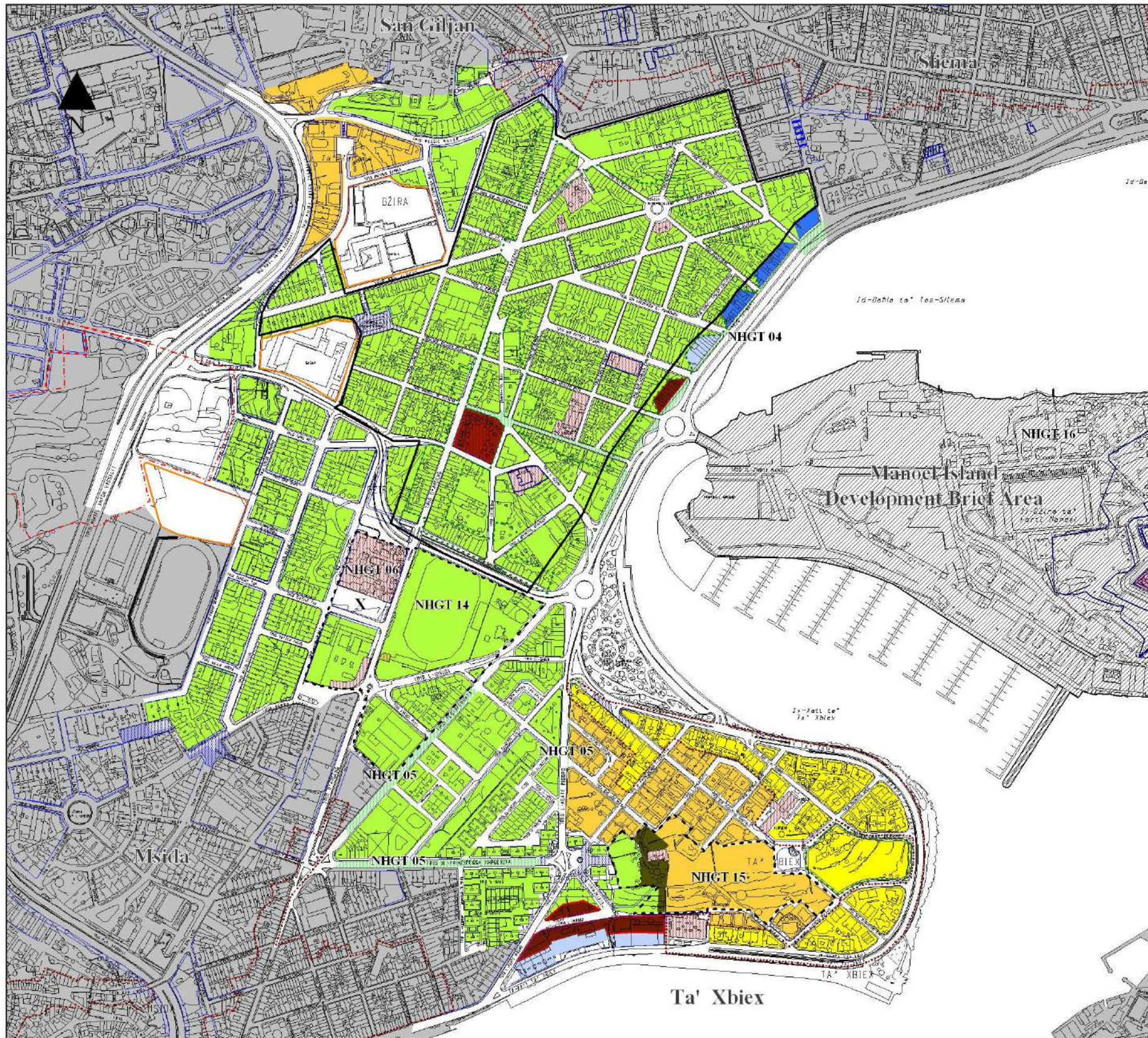

NORTH HARBOURS LOCAL PLAN

MEPA
 AWTORITA' TA' MALTA DWAR L-AMBIENT U-L-IPPJANAR
 MALTA ENVIRONMENT & PLANNING AUTHORITY

Key Building Height Limitations
NHSE 04, NHGT 07

Outside UCA
 (All floors indicated here are with semi-basement)

| | | |
|----------|----------|----------|
| 2 Floors | 3 Floors | 4 Floors |
| 5 Floors | 6 Floors | 7 Floors |

Within UCA
 (All floors indicated here are without semi-basement)

| |
|----------|
| 2 Floors |
|----------|

- Institutional Buildings or Other Sites with no Specified Building Height NHSE04
- Upgrading of Public Open Space NHSE 05
- Landmark Buildings NHSE 08
- Environmental Improvements NHGT 04, 05
- Opportunity Sites NHGT 06, 14, 15
- Manoel Island Development Brief Area NHGT 16
- Design Priority Area NHGT 08
- Urban Conservation Area NHSE 09
- No semi-basement within area enclosed by black line
- Proposed Limit to Development NHSE 01
- Existing Limit to Development (TPS)
- Scheme Alignment
- Qualifying for Scheduling
- Scheduled Sites/Areas

Properties of cultural importance may be added in the course of completing the National Protective Inventory of the Maltese Islands, or removed if officially descheduled.
 For Scheduled buildings, where no specific building height is shown, Structure Plan UCO policies apply.

Gzira & Ta' Xbiex
Building Heights & Urban Design

| | | |
|--------------------------|----------------------------|--------------------|
| Scale : 1:5500 | Date : July 2006 | Map: GT2 |
|--------------------------|----------------------------|--------------------|

INDICATIVE ONLY
 Not to be used for direct interpretation or for the interpretation of street alignments.

Base Maps - 1988 Survey Sheets
 Copyright Mapping Unit, Malta Environment & Planning Authority

1BLHIG09C00

Annex Nr 3 – Permit Document and Drawings

Mr. Kurt Abela

Date: 29 January 2019
Our Ref: PA/02735/18

Application Number: PA/02735/18
Application Type: Full development permission
Date Received: 29 December 2017
Approved Documents: PA 2735/18/1A/55B/55C/55D/55E/55F/55G/55H/55I

Supporting Documents

PA 2735/18/33A - Water Services Corporation
PA 2735/18/39A/39B - Malta Tourism Authority
PA 2735/18/50B - Environmental Health Directorate
PA 2735/18/78A - Superintendence of Cultural Heritage
PA 2735/18/81A/62A - Engineer's Report
PA 2735/18/73A - Works Method Statement
PA 2735/18/65A - Commission for the Rights of Persons with Disability

Location: 43, Triq Sir William Reid c/w, Triq Carlo Manche, Gzira, Malta
Proposal: To convert existing first floor maisonette & overlying airspace into a guest house (Class 3a) to be built on four floors (1st, 2nd, 3rd and 4th floor levels) and a recessed floor at 5th floor level.

**Development Planning Act, 2016
Full Development Permission**

The Planning Authority hereby grants development permission in accordance with the application and documents described above, subject to the following conditions:

- 1 a) This development permission is valid for a period of FIVE YEARS from the date of publication of the decision in the press but will cease to be valid if the development is not completed by the end of this validity period.
- b) This permission relates only to the development as specifically indicated on the approved drawings. This permission does not sanction any other illegal development that may exist on the site.
- c) A Commencement Notice is to be submitted to the Planning Authority, by the perit on behalf of the applicant, at least FIVE DAYS prior to the date of commencement of works or utilisation of the permission. Failure to submit the Commencement Notice (with all fields correctly completed) or failure to submit it within the required timeframe shall invalidate the Notice and shall result in the imposition of fines according to Schedule D of

Legal Notice 277 of 2012, or its amendments, or its replacements. In addition, **if the applicant fails to submit the Commencement Notice or the Commencement Notice submitted is invalid, the relative permission shall be considered as never having been utilised** - Article 72(4) of the Development Planning Act (2016).

d) Copies of all approved drawings and documents shall be available for inspection on site by Planning Authority officers at all reasonable times.

e) The development shall be carried out in complete accordance with the approved drawings, documents and conditions of this permission. Where a matter is not specified, then the conditions of this permission and of Development Control Design Policy, Guidance and Standards 2015 shall apply.

f) Before any part of the development hereby permitted commences, the enclosed green copy of this development permission shall be displayed on the site. This must be mounted on a notice board, suitably protected from the weather and located not more than 2 metres above ground level at a point on the site boundary where it is clearly visible and can be easily read from the street. The copy of the permission must be maintained in a good condition and it shall remain displayed on the site until the works are completed.

g) All building works shall be erected in accordance with the official alignment and official/existing finished road levels as set out on site by the Planning Authority's Land Surveyor. The Setting Out Request Notice must be submitted to the Land Survey Unit of the Planning Authority when the setting out of the alignment and levels is required.

h) Where an officially schemed street, within the development zone, bordering the site is unopened or unformed, it shall be opened up and brought up to its proper, approved and official formation levels prior to the commencement of any development hereby being permitted.

i) It is the responsibility of the permit holder to ensure that development is carried out in accordance with the provisions of the Environmental Management Construction Site Regulations, Legal Notice 295 of 2007 (or subsequent amendments). Any hoarding shall be erected in accordance with Schedule 2 of the same Regulations.

j) New development on vacant or redeveloped sites shall be provided with a water cistern to store rainwater run-off as required by the Energy Performance of Buildings Regulations (2012) [published through Legal Notice 376 of 2012 and any amendments thereto].

k) No steps, ramps or street furniture are to be constructed on or encroached onto the public pavement or road.

l) Any doors and windows, the lower edge of which is less than 2m above road level, and any gates shall not open outwards onto a public pavement or road.

m) Where present, window grilles (including 'pregnant' windows), sills, planters and other similar elements which are part of or fixed to the facade of buildings, the lower edge of which is less than 2 metres above road level, shall not project more than 0.15 metres from the facade over a public pavement or street.

n) Air conditioning units shall not be located on the facades of the building which are visible from the street or a public space.

o) There shall be no service pipes, cables or wires visible on the front elevation or on any

other elevations of the building which are visible from the street or public space.

- 2
 - a) The façade(s) of the building shall be constructed in local un-rendered and unpainted stone, except where other materials/finishes are indicated on the approved drawings.
 - b) All the apertures and balconies located on the façade(s) of the building shall not be in gold, silver or bronze aluminium.
 - c) Where a front garden is imposed, the 'solid part' of the boundary wall in the front garden shall not be higher than 1.4 metres above the external finished road level. Where the road is sloping, the wall shall be stepped accordingly. Any pillars or gateposts shall not exceed a height of 2.25 metres.
 - d) The height of the services on the roof of the building shall not extend beyond the approved height of the uppermost parapet wall.
- 3

The approved premises shall be used as indicated on the approved drawings or as limited by any condition of this permission. If a change of use is permitted through the Development Planning (Use Classes) Order, 2014 (or its subsequent amendments), and it is not restricted by a condition of this permission, approval from the Commission for the Rights of Persons with Disability may still be required. Reference needs to be made to PA Circular 3/10 (with the exception of Appendix A), PA Circular 2/14 and their subsequent amendments.

The breakfast area approved with this development permission shall be ancillary to the overall use of the building as a Class 3A Guesthouse. The catering use shall not be segregated from the approved Class 3A use.
- 4

No approval is hereby granted for the display of any sign or advertisement. This must be subject of a separate application.
- 5

The conditions imposed and enforced by the Water Services Corporation (WSC) are at supporting document PA 2735/18/33A. The architect/applicant is required to contact the WSC, throughout the implementation of the development hereby approved, to ensure conformity with the imposed conditions. A copy of the relative correspondence issued by the WSC shall be submitted to the Planning Authority accordingly.
- 6

The conditions imposed and enforced by the Malta Tourism Authority (MTA) are at supporting document PA 2735/18/39A/39B. The architect/applicant is required to contact the MTA, throughout the implementation of the development hereby approved, to ensure conformity with the imposed conditions. A copy of the relative correspondence issued by the MTA shall be submitted to the Planning Authority accordingly.
- 7

The conditions imposed and enforced by the Environmental Health Directorate (EHD) are at supporting document PA 2735/18/50B. The architect/applicant is required to contact the EHD, throughout the implementation of the development hereby approved, to ensure

conformity with the imposed conditions. A copy of the relative correspondence issued by the EHD shall be submitted to the Planning Authority accordingly.

- 8 The conditions imposed and enforced by the Superintendence of Cultural Heritage (SCH) are at supporting document PA 2735/18/78A/73A. The architect/applicant is required to contact the SCH, throughout the implementation of the development hereby approved, to ensure conformity with the imposed conditions. A copy of the relative correspondence issued by the SCH shall be submitted to the Planning Authority accordingly.

- 9 The development hereby permitted shall be subject to Final Compliance (Completion) Certification, verifying that the development has been carried out in full accordance with the approved drawings, documents and conditions imposed in this development permission, except where such conditions are enforced by other entities. Prior to the issue of any compliance certificate on any part of this development, the applicant shall submit to Planning Authority, in relation to that part of the building:
 - (i) Clearance from the Commission for the Rights of Persons with Disability verifying that the development fully satisfies the accessibility standards and/or any conditions imposed by the Commission in supporting document PA 2735/18/165A.

Note: Should a partial compliance certificate be requested, a Bank Guarantee of €25,000 shall apply to ensure that CRPD clearance is obtained.
 - (ii) Certification from a qualified engineer confirming that the development fully satisfies the requirements specified in supporting document PA 2735/18/81A/62A.

- 10 To make up for the shortfall in parking provision of two parking spaces, this development permission is subject to a contribution amounting to the sum of €2,329.37 (two thousand, three hundred, twenty nine Euro and thirty seven cent) in favour of Planning Authority's Urban Improvements Fund for the locality. The funds raised shall be used to fund traffic management, green transport, urban improvements or similar projects. The contribution shall be utilised as required and directed by Planning Authority.

- 11 This permission is subject to a Bank Guarantee to the value of €1,677.24 (one thousand, six hundred, seventy seven Euro and twenty four cent) to ensure that the street is properly restored in accordance with the Environmental Management Construction Site Regulations, 2007 (Legal Notice 295 of 2007). The bank guarantee shall only be released after the perit submits a post-construction condition report together with photographs evidencing compliance with this condition, accompanied by clearance from the Local Council. The clearance from the Local Council is to be endorsed by the Mayor and the Executive Secretary of the Local Council. This guarantee shall be forfeited if, after 3 months from the date of notification by the Authority of a notice to effect the remedial works, these are not carried out. Its forfeiture shall not, however, preclude the applicant from adhering to all the conditions contained in this development permission.

12 **Conditions imposed and enforced by other entities**

A. Where construction activity is involved:

(a) the applicant shall:

(i) **Appoint a Project Supervisor for the Design Stage and a Project Supervisor for the Construction Stage** and any such appointment shall be terminated, changed or renewed as necessary. The same person may be appointed to act as project supervisor for both the design and construction stage, if that person is competent to undertake the duties involved and

(ii) **Keep a health and safety file** prepared by the Project Supervisor for the Design Stage.

(b) When the construction works related to this application are scheduled to last longer than thirty working days and on which more than twenty workers are occupied simultaneously, or on which the volume of work is scheduled to exceed five hundred person-days, the project supervisor **shall communicate a prior notice to the Occupational Health and Safety Authority (OHSA) at least four calendar weeks before commencement of works.**

(c) The Project Supervisor for the Design Stage shall **draw up a health and safety plan** which sets out the occupational health and safety rules applicable to the construction activities concerned, outlining the measures to ensure cooperation between different contractors and shall also include specific measures concerning occupational risks that may be present at this site.

B. Where the development concerns a change of use to a place of work, the applicant shall obtain a Perit's declaration that the building conforms to the requirements of LN 44 of 2002.

C. Where the development concerns a place of work:

The applicant shall:

(i) obtain a Perit's declaration that the necessary requirements arising out of LN 44 of 2002 have been included in the plans and drawings; and

(ii) obtain a Perit's declaration that the building conforms to the requirements of LN 44 of 2002.

D. The development is to strictly adhere to the 'Design Guidelines on fire safety for buildings in Malta' to ensure that all Fire Safety measures and provisions are addressed as indicated in the Design Guidelines on Fire Safety for Buildings in Malta, published by the DCID in 2004, (or other relevant standard, provided it is approved by the Civil Protection Department), Policies, and the Laws and Regulations of Malta.

E. Where the development includes a livestock farm:

(a) The farm **shall not** be connected directly to the sewer network.

(b) Silting traps, sedimentation pits as well as manure clamps shall be installed, as shown on the approved drawings. Settled Waste water shall only be discharged in approved waste receiving stations.

(c) Any effluents discharged shall have chloride levels lower than 1000 mg/L. The operators shall acquire a Public Sewer Discharge Permit before commencing operations.

F. Where the development includes a swimming pool:

(a) Any effluent, if discharged in the sewers, shall meet the specifications listed in L.N.139 of 2002 as amended by L.N.378 of 2005.

(b) Adequate sampling points should be installed as directed by WSC – Discharge Permit Unit officials.

(c) Chlorine concentration of the effluent should not exceed 100 mg/L Cl₂.

G. Prior to laying of water and wastewater services in the road, the development shall comply with the requirements of Legal Notice 29/10 Part III (Roads in inhabited Areas) Clause 12.

H. In the event of an accidental discovery in the course of approved works, any cultural heritage feature discovered should not be damaged or disturbed and the Superintendence is to be immediately informed of such discovery. Any cultural heritage features discovered are to be investigated, evaluated and protected in line with the Cultural Heritage Act 2002 (CAP 445). The discovery of cultural heritage features may require the amendment of approved plans.

In terms of Article 72(3) of the Development Planning Act, 2016, the execution and validity of this permission is automatically temporarily **suspended** and no works as approved by the said development permission may commence before the lapse of the time period established in Article 13 of the Environment and Planning Review Tribunal Act and subsequently will remain so suspended if the Tribunal so decides in accordance with the Environment and Planning Review Tribunal Act.

Where the approved drawings and/or documents are dimensioned, then the declared dimensions shall prevail over the actual size as depicted on the approved drawings and/or documents.

Developers are advised to check the invert level to the sewer main with the Water Services Corporation as they would have to make their own arrangements where a gravity service connection is not possible. In these cases, the architect has to indicate the solutions envisaged and to indicate on the plan what needs to be carried out and obtain approval from WSC. Developers are further reminded that connection of storm water into main sewers is not allowed.

If the declaration of ownership, as contained in the application form, is determined as incorrect by a Court of Law, then the said Court of Law can declare this development permission as null and void. This development permission does not remove or replace the need to obtain the consent of the land/building owner to this development before it is carried out. Furthermore, it does not imply that consent will necessarily be forthcoming nor does it bind the land/building owner to agree to this development. Where the land/building is owned or administered by the Government of Malta a specific clearance and agreement must be obtained for this development from the Land and/or Estate Management Departments.

This development permission is granted saving third party rights. This permission does not exonerate the applicant from obtaining any other necessary permission, license, clearance or approval required from any Government department, local council, agency or authority, as required by any law or regulation.

This development permit does not authorise any storage of substances listed in Occupational Health and Safety Authority Act (Cap. 424) - Control of Major Accident Hazards Regulations, 2003, as amended, in quantities that would render this site an establishment within scope of these regulations. The storage and handling of said substances may require a new or amended development permission in line with current policies and regulations.

For any non-residential uses hereby being approved, prior to commencement of any works on site or any eventual permitted change of use, the applicant shall be required to contact the Environment and Resources Authority to obtain any necessary operational permit or registration. This requirement does not apply to Class 2B, 2C, 4A and 4B uses as listed in the Development Planning (Use Classes) Order 2014, or its subsequent amendments.

This decision is being published on 13 February 2019.

Marthese Debono
Secretary Planning Commission
Within Development Scheme

Notes to Applicant and Perit

Right for reconsideration

Where applicable, you have a right to submit a request for reconsideration to the Authority in terms of regulation 14 of Legal Notice 162 of 2016.

Right for appeal

You have a right to submit an appeal, against the decision, to the Environment and Planning Review Tribunal in terms of Article 13 of the Environment and Planning Review Tribunal Act, 2016.

Time limits

Requests for reconsideration or appeals must be made within 30 days from the publication of the decision notification in the local press as required by regulation 14(1) of Legal Notice 162 of 2016.

Fees to submit a request for reconsideration or appeal

In either case, there is a fee to be paid which should accompany the request for reconsideration or the appeal. The fees are as follows:

For reconsideration - 3% of the Development Permit Fee paid in respect of the original application, subject to a minimum of €69.88.

For appeal - 5% of DPF (Development Permit Fee) paid in respect of the original application, subject to a minimum of €150 + €50 administrative fee (LN 112 of 2016).

Submission of request for reconsideration or appeal

With regards to requests for reconsideration, Form PA 4/16 must be used for submission. All fields of the Form must be filled in as appropriate. Requests for reconsideration can only be submitted electronically.

With regards to appeals, as required by Article 13 of the Environment and Planning Review Tribunal Act, 2016, the submission must include the detailed grounds for appeal and the requests being made by the appellant. Appeals must be submitted physically at the offices of the Environment and Planning Review Tribunal, St. Francis Ditch, Floriana.

Important Notice

In view of the provisions of Article 72(4) of the Development Planning Act (2016), a Commencement Notice is to be submitted to the Planning Authority, by the perit on behalf of the applicant, at least FIVE DAYS prior to the date of commencement of works or utilisation of the permission. Failure to submit the Commencement Notice (with all fields correctly completed) or failure to submit it within the required timeframe shall invalidate the Notice and shall result in the imposition of fines according to Schedule D of Legal Notice 277 of 2012, or its amendments, or its replacements. In addition, if the applicant fails to submit the Commencement Notice or the Commencement Notice submitted is invalid, the relative permission shall be considered as never having been utilised.

-PADCN-

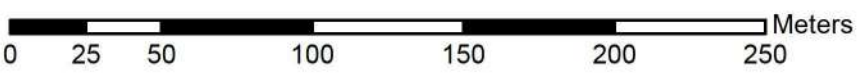
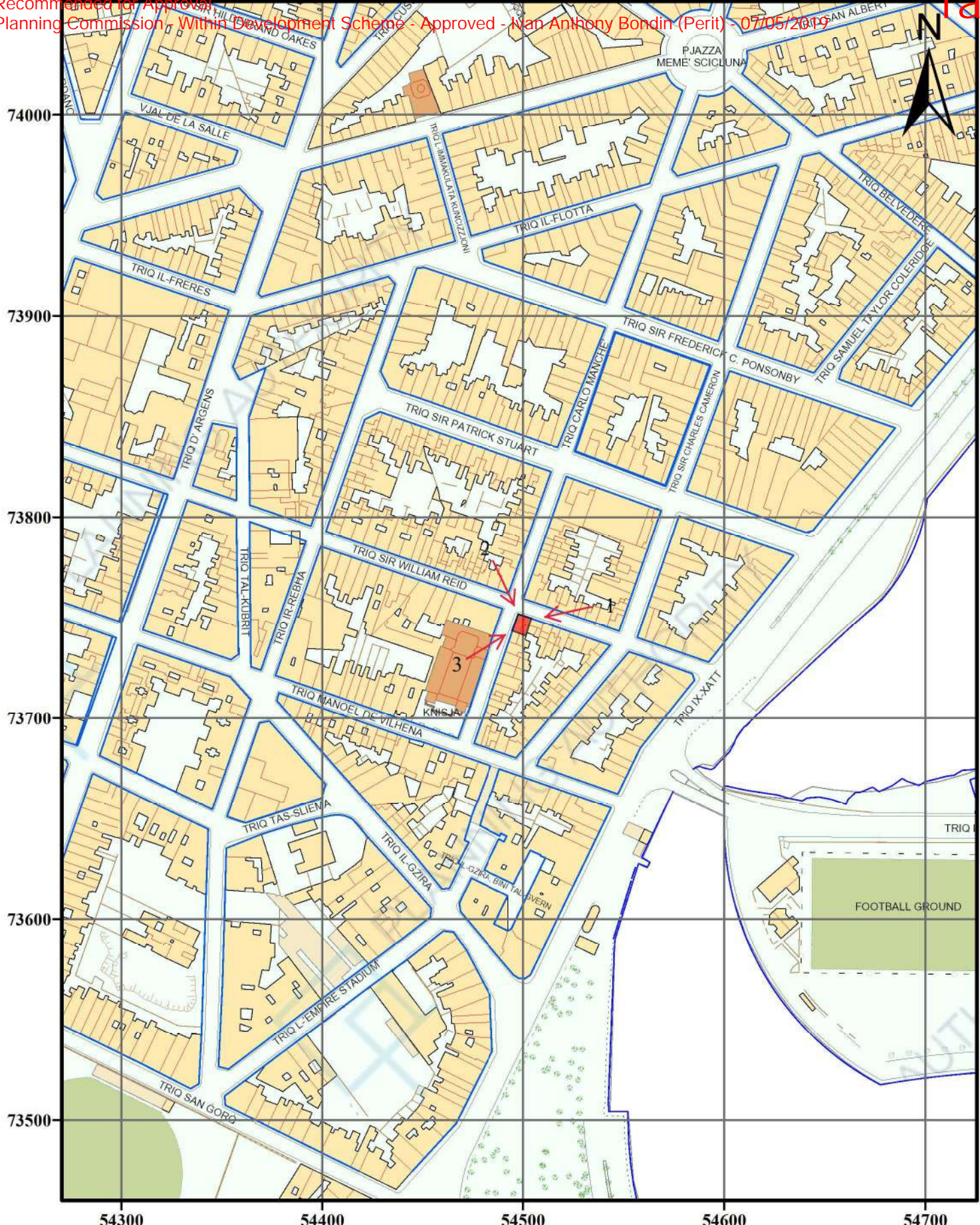

1:2,500 Date Printed: 24/09/2017

Public Geoserver

Compiled and published by the Mapping Unit, Planning Authority ©PA.
 Reproduction in whole or in part by any means is prohibited without the prior permission of the Mapping unit.
 Data Captured from: 1988, 1994, 1998, 2004 & 2008 aerial photography and updates from 2012 orthophotos.
 Truncated U.T.M. Coordinates. Levelling Datum M.S.L. (Mean sea level). Contours when shown are at 2.5m vertical interval. Not to be used for interpretation or scaling of scheme alignments

PLANNING AUTHORITY
 St.Francis Ravelin, Floriana.
 Tel: +356 2290 0000, Fax: +356 2290 2295
 www.pa.org.mt, mappingshop@pa.org.mt

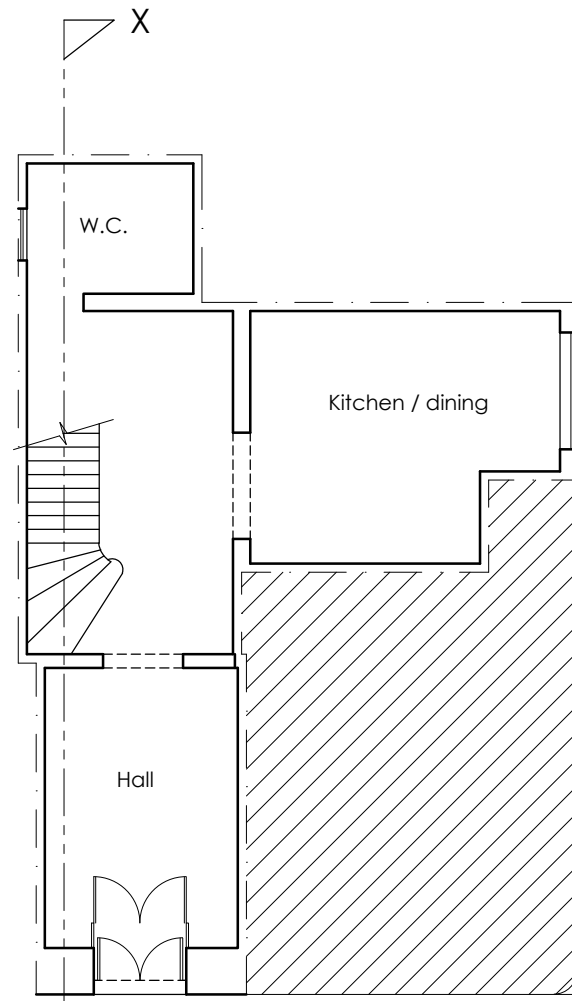

01
 GROUND FLOOR
 LEVEL AS EXISTING
 SCALE 1:100

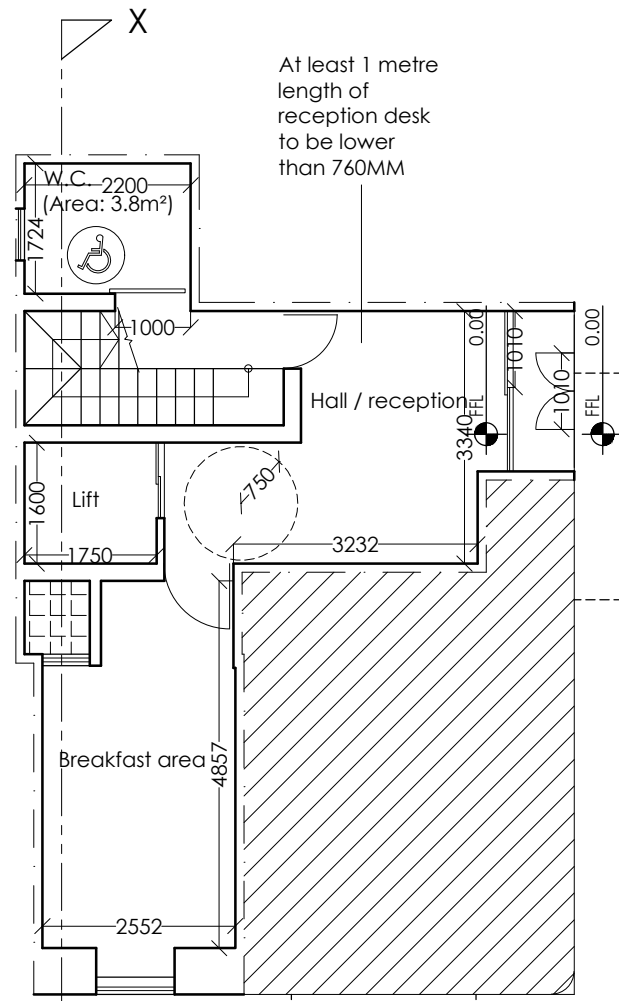

02
 GROUND FLOOR
 LEVEL AS PROPOSED
 SCALE 1:100

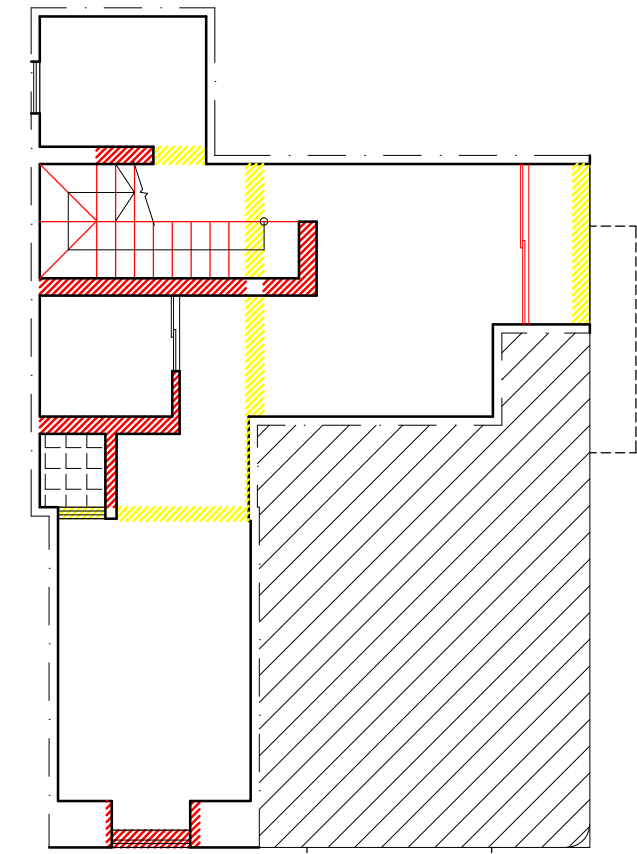

03
 GROUND FLOOR LEVEL
 EXISTING VS PROPOSED
 SCALE 1:100

| | |
|--|-----------------------|
| | Existing to demolish |
| | Proposed to construct |

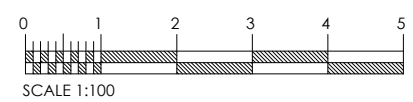

Perit Ivan A. Bondin
 B.E.&A.(Hons.), M.Sc.(Edin.), A.&C.E.
 La Pietra', 38, Triq ix-Xriek, Mqabba, MQB 1320.
 Tel: 21683147 Mob: 79594078 Mail: bondin@onvol.net

| | |
|---|------------------------|
| Job Description: To convert existing first floor maisonette & overlying airspace into a guest house (Class 3a) to be built on four floors (1st, 2nd, 3rd and 4th floor levels) and a reseed floor at 5th floor level. | Scale: 1:100 |
| Title: Ground level | Drawing Nr. A001_Rev01 |
| | 13-06-2018 |
| | Drawn by: C.M. |

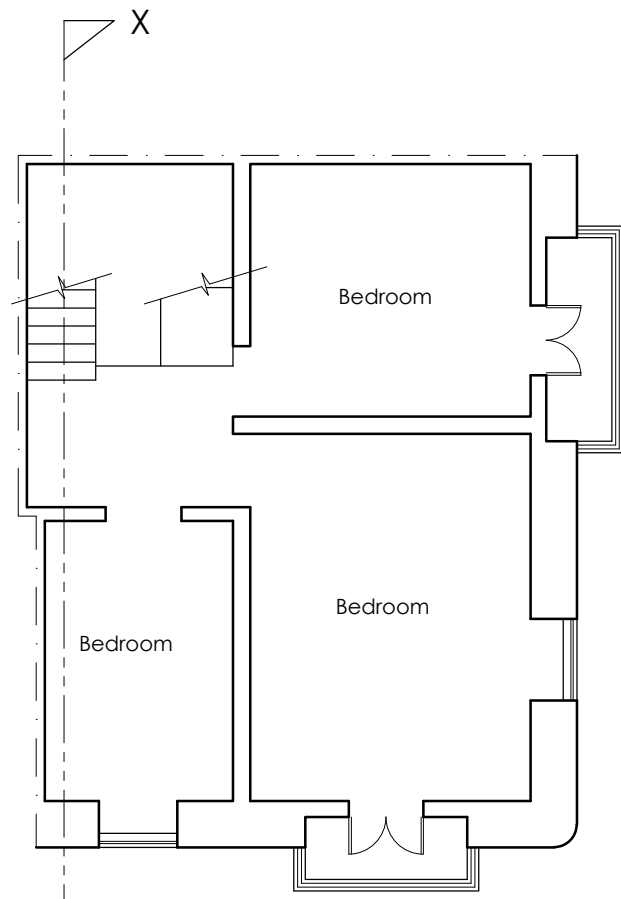

01
 --
 FIRST FLOOR
 LEVEL AS EXISTING
 SCALE 1:100

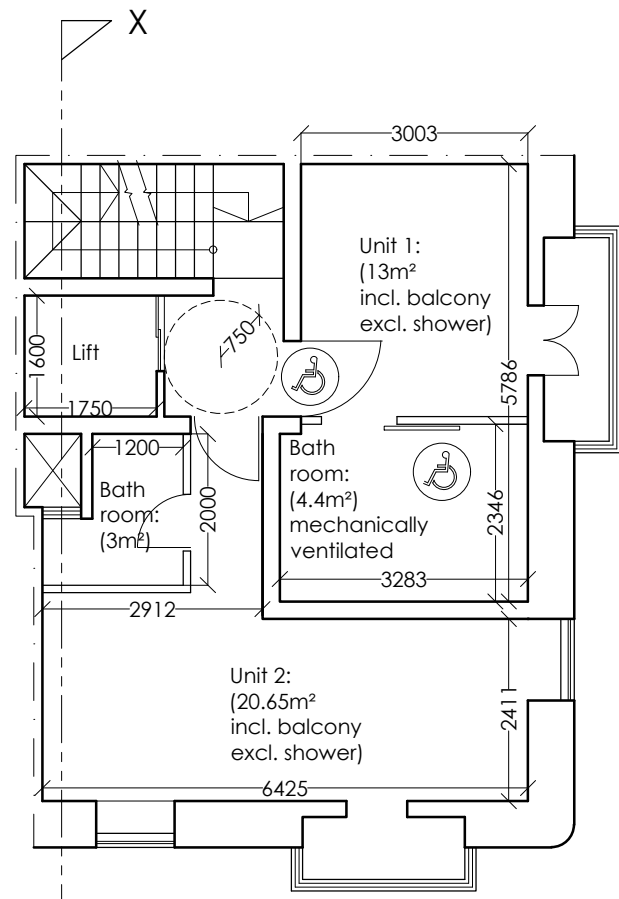

02
 --
 FIRST FLOOR
 LEVEL AS PROPOSED
 Floor area: 55m
 SCALE 1:100

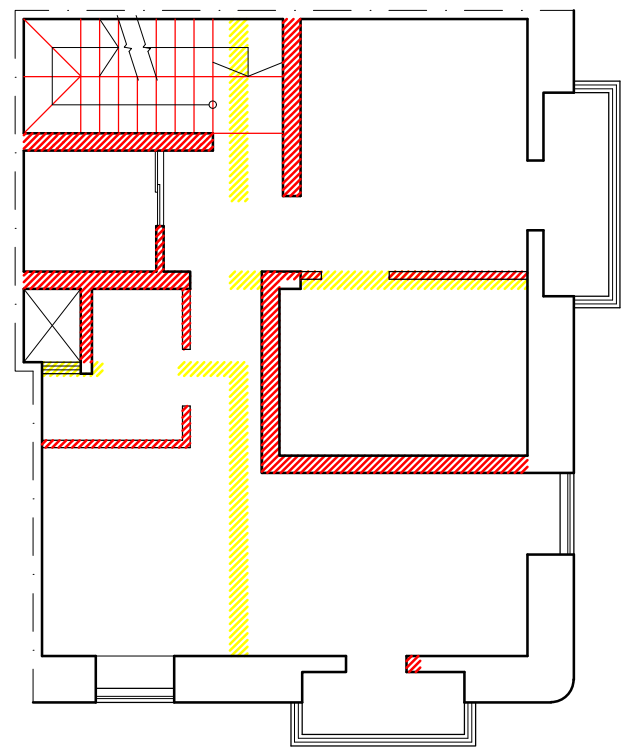

03
 --
 FIRST FLOOR LEVEL
 EXISTING VS PROPOSED
 SCALE 1:100

| | |
|--|-----------------------|
| | Existing to demolish |
| | Proposed to construct |

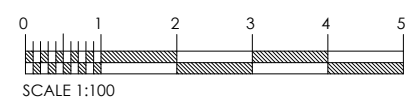

| | | |
|--|---|--|
| Perit Ivan A. Bondin B.E.&A.(Hons.), M.Sc.(Edin.), A.&C.E. La Pietra', 38, Triq ix-Xriek, Mqabba, MQB 1320. Tel: 21683147 Mob: 79594078 Mail: bondin@onvol.net | Job Description: To convert existing first floor maisonette & overlying airspace into a guest house (Class 3a) to be built on four floors (1st, 2nd, 3rd and 4th floor levels) and a recced floor at 5th floor level. | Scale: 1:100 Drawing Nr. A002_Rev01 13-06-2018 Drawn by: C.M. |
| | Title: First floor level | |

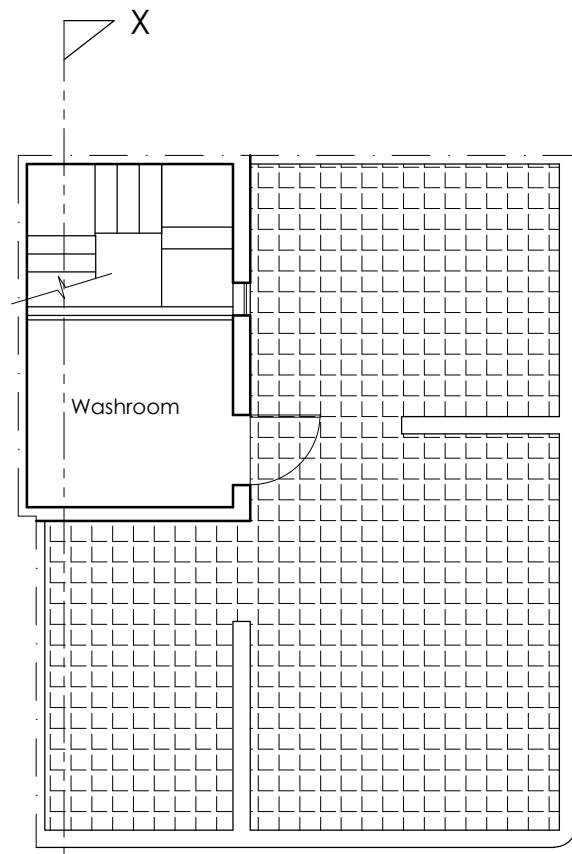

01
 --
 X SECOND FLOOR
 LEVEL AS EXISTING
 SCALE 1:100

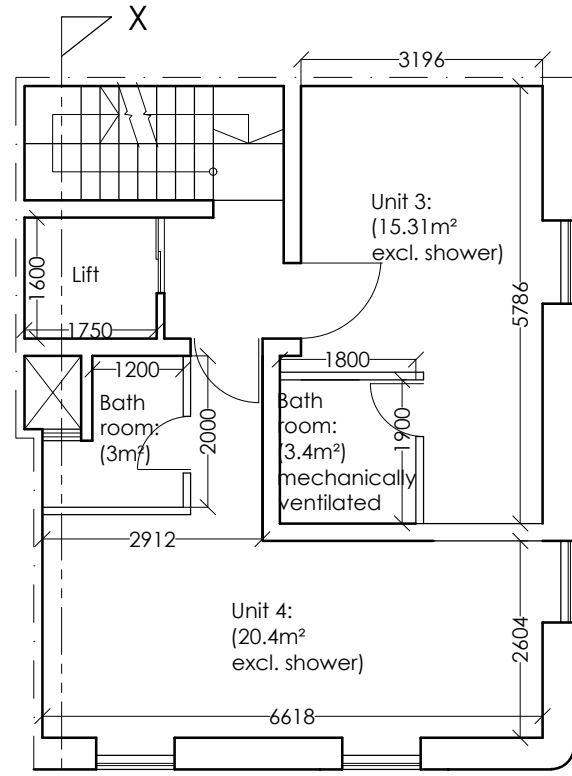

02
 --
 X SECOND FLOOR
 LEVEL AS PROPOSED
 Floor area: 55m SCALE 1:100

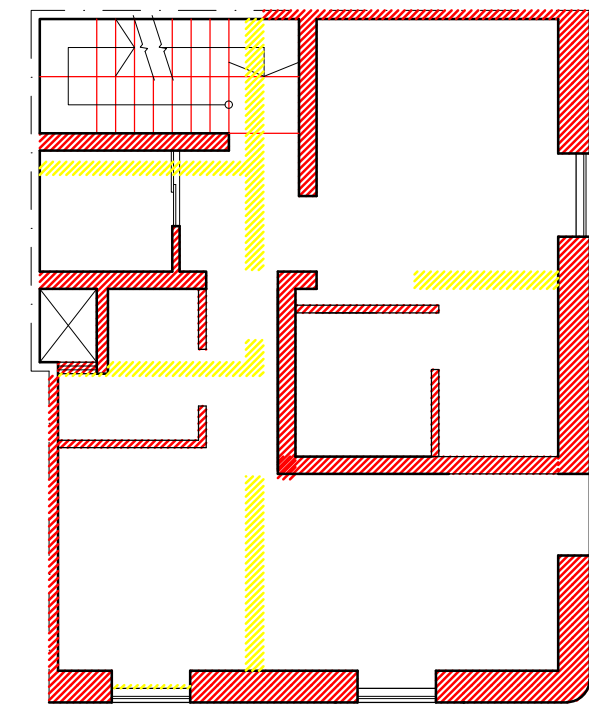

03
 --
 SECOND FLOOR LEVEL
 EXISTING VS PROPOSED
 SCALE 1:100

| | |
|--|-----------------------|
| | Existing to demolish |
| | Proposed to construct |

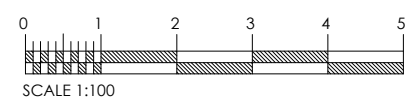

| | | |
|--|---|--|
| Perit Ivan A. Bondin B.E.&A.(Hons.), M.Sc.(Edin.), A.&C.E. La Pietra', 38, Triq ix-Xriek, Mqabba, MQB 1320. Tel: 21683147 Mob: 79594078 Mail: bondin@onvol.net | Job Description: To convert existing first floor maisonette & overlying airspace into a guest house (Class 3a) to be built on four floors (1st, 2nd, 3rd and 4th floor levels) and a reseed floor at 5th floor level. | Scale: 1:100 Drawing Nr. A003_Rev01 13-06-2018 |
| | Title: Second floor level | Drawn by: C.M. |

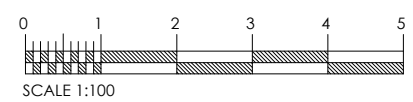
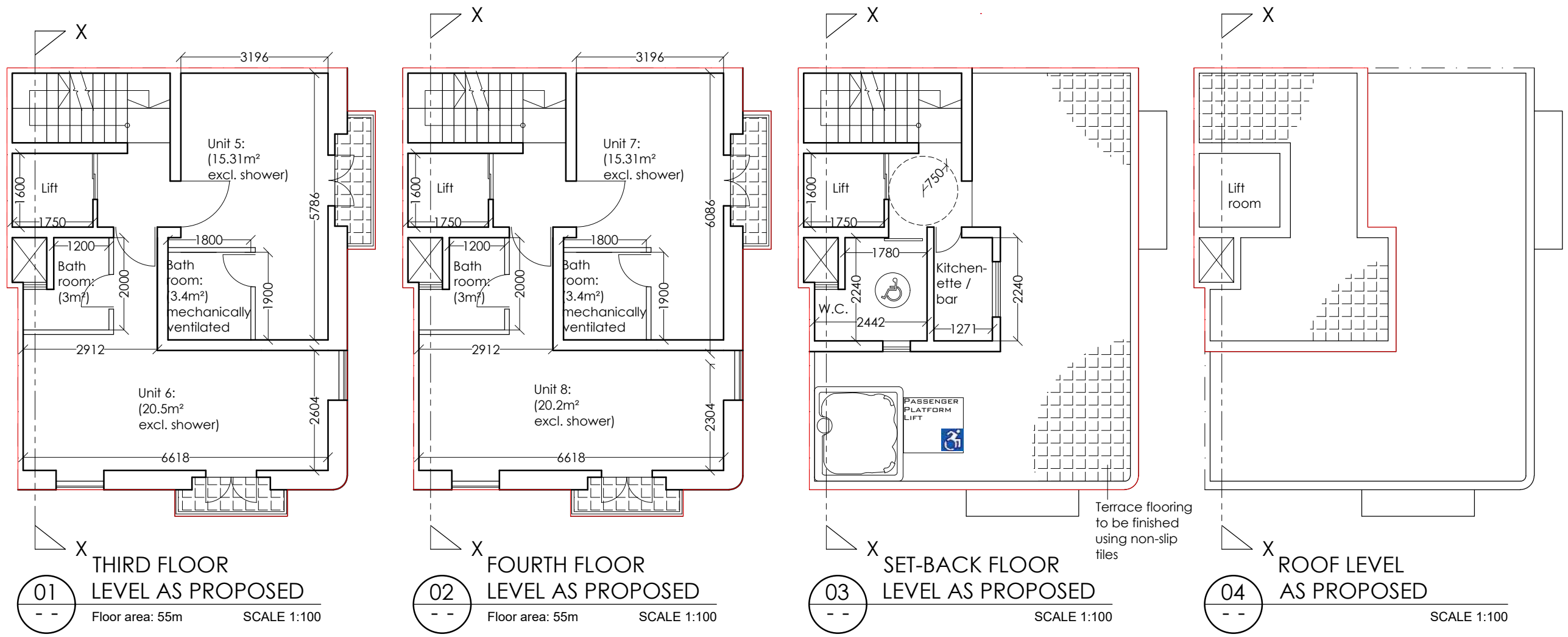

Perit Ivan A. Bondin
 B.E.&A.(Hons.), M.Sc.(Edin.), A.&C.E.
 La Pietà, 38, Triq ix-Xriek, Mqabba, MQB 1320.
 Tel: 21683147 Mob: 79594078 Mail: bondin@onvol.net

| | |
|--|------------------------|
| Job Description: To convert existing first floor maisonette & overlying airspace into a guest house (Class 3a) to be built on four floors (1st, 2nd, 3rd and 4th floor levels) and a reeceed floor at 5th floor level. | Scale: 1:100 |
| Title: Proposed third, fourth, set-back and roof levels | Drawing Nr. A004_Rev01 |
| | 13-06-2018 |
| | Drawn by: C.M. |

| | |
|--|-----------------------|
| | Existing to demolish |
| | Proposed to construct |

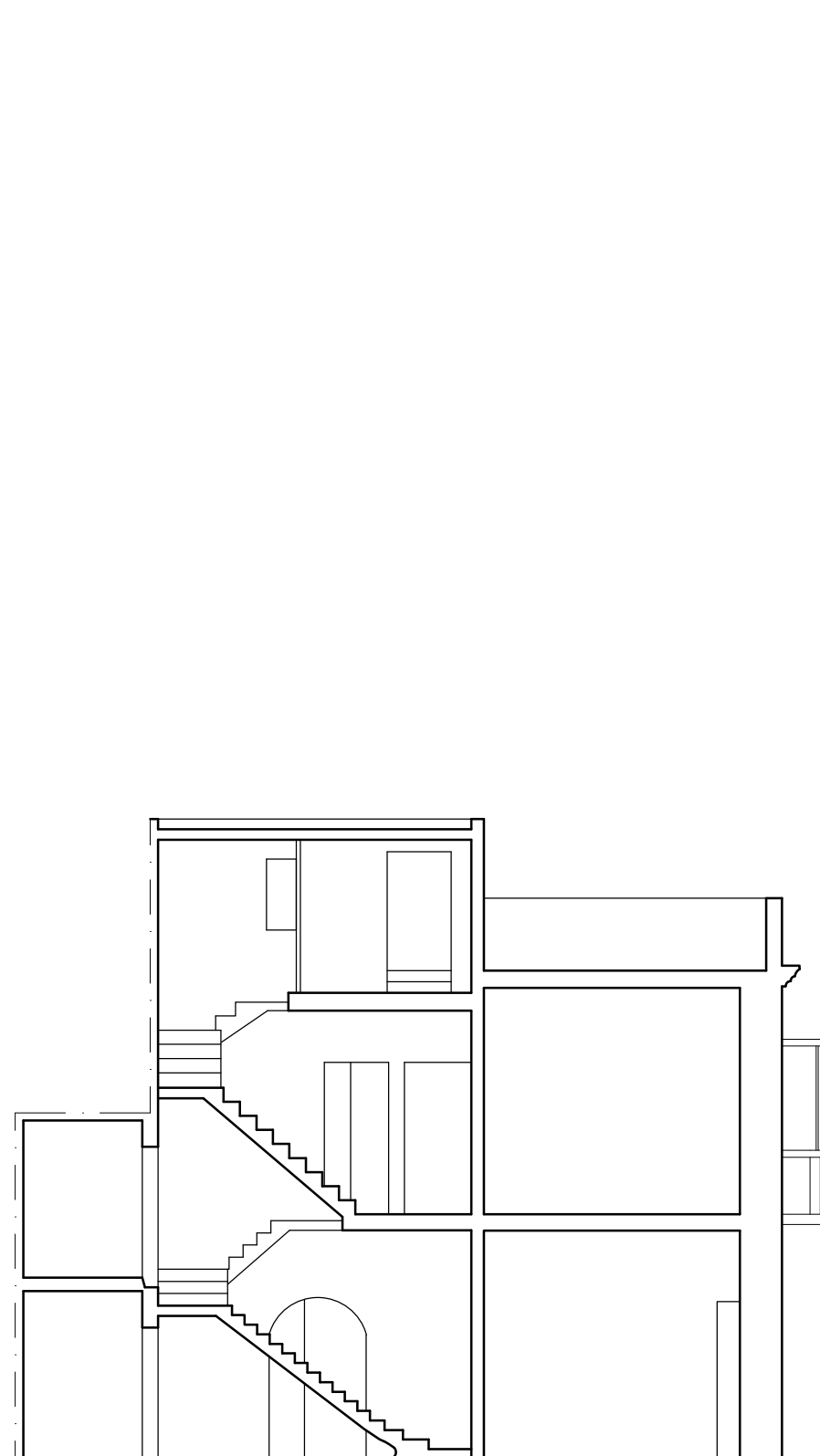

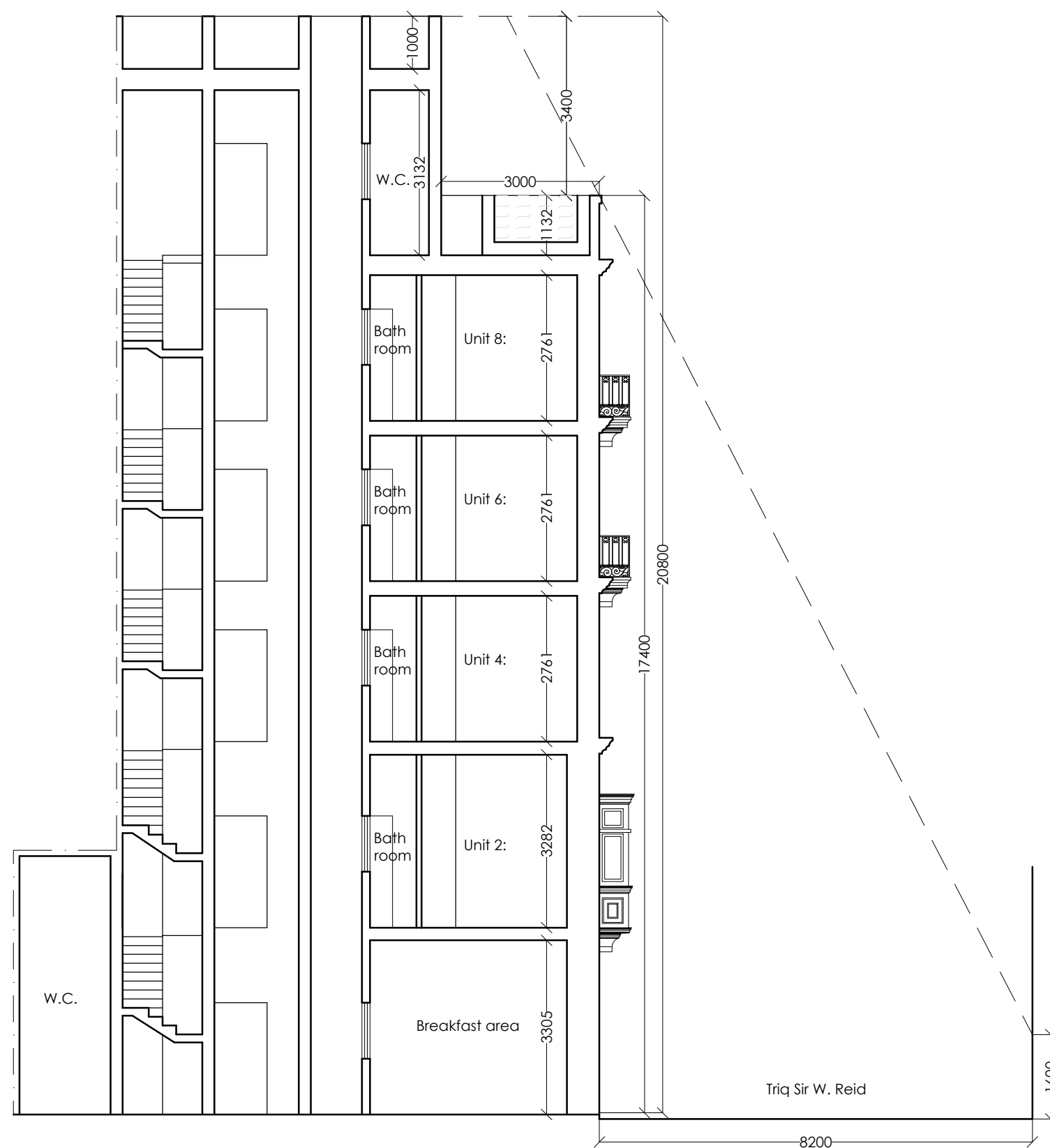

01
 SECTION THROUGH
 X-X AS EXISTING
 SCALE 1:100

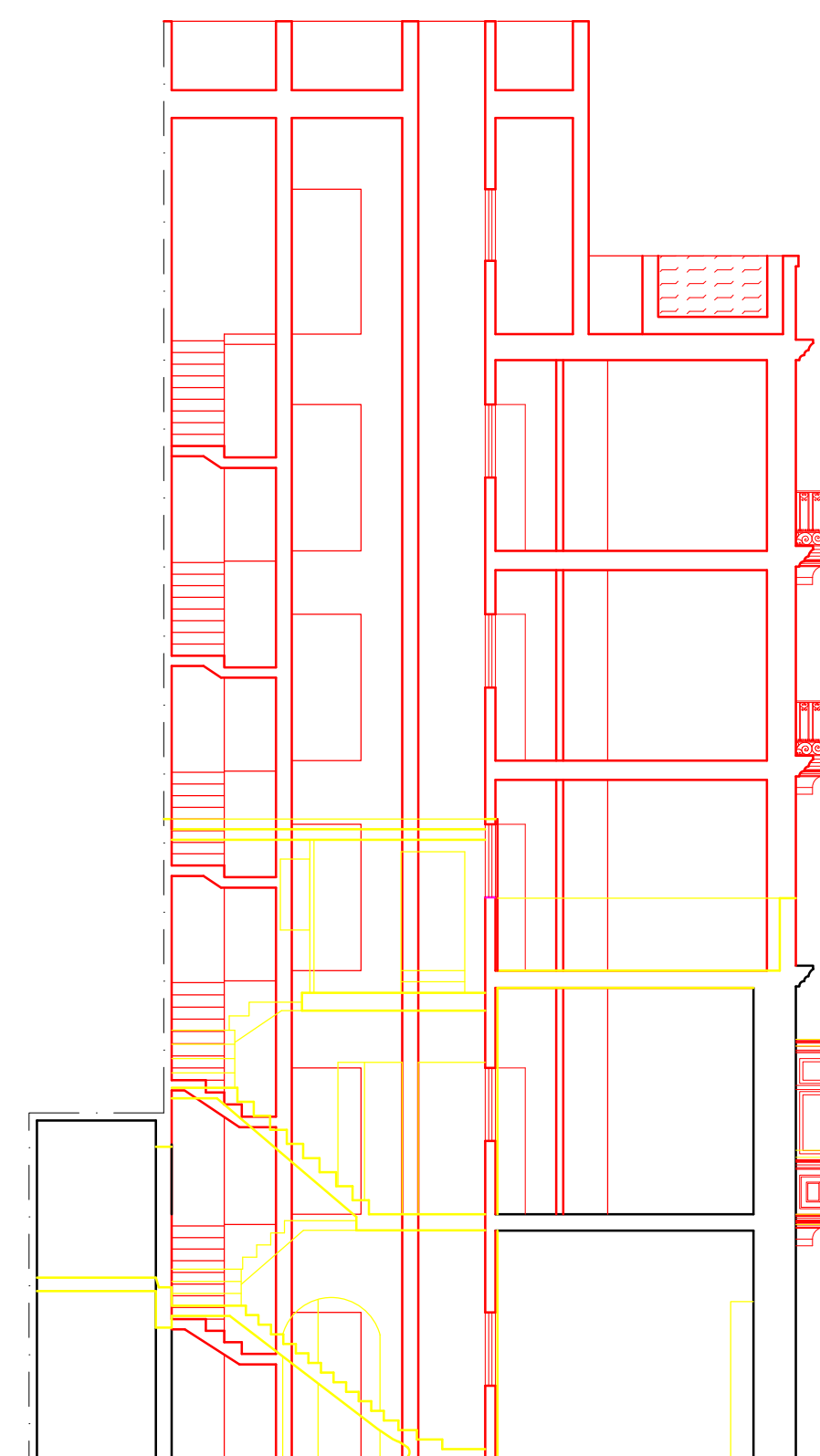

02
 SECTION THROUGH
 X-X AS PROPOSED
 SCALE 1:100



03
 SECTION THROUGH
 X-X EXISTING VS PROPOSED
 SCALE 1:100

| | |
|---|-----------------------|
|  | Existing to demolish |
|  | Proposed to construct |

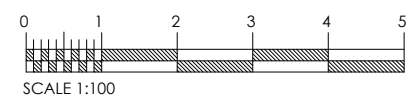

| | | |
|--|---|--|
| Perit Ivan A. Bondin B.E.&A.(Hons.), M.Sc.(Edin.), A.&C.E. La Pietà, 38, Triq ix-Xieki, Mgabba, MQB 1320. Tel: 21683147 Mob: 79594078 Mail: bondin@onvol.net | Job Description: To convert existing first floor maisonette & overlying airspace into a guest house (Class 3a) to be built on four floors (1st, 2nd, 3rd and 4th floor levels) and a reseed floor at 5th floor level. | Scale: 1:100 Drawing Nr. A005_rev01 |
| | Title: Section through X-X | 13-06-2018 Drawn by: C.M. |



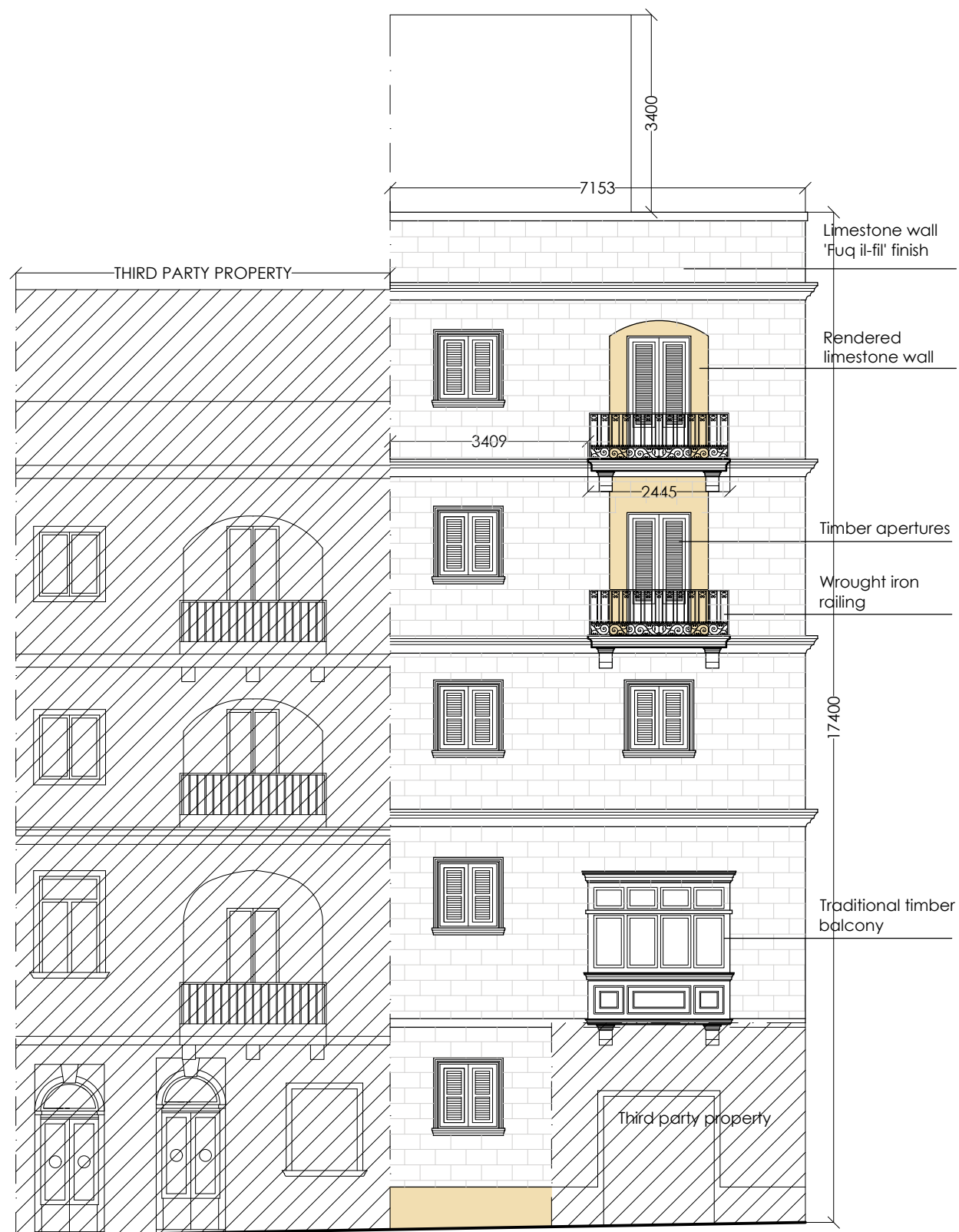

01
 --
 ELEVATION IN TRIQ SIR
 W. REID AS EXISTING
 SCALE 1:100



02
 --
 ELEVATION IN TRIQ SIR
 W. REID AS PROPOSED
 SCALE 1:100



03
 --
 ELEVATION IN TRIQ SIR W. REID
 EXISTING VS PROPOSED
 SCALE 1:100

| | |
|---|-----------------------|
|  | Existing to demolish |
|  | Proposed to construct |

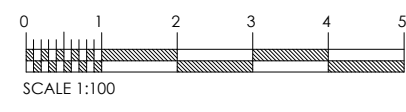

| | | |
|---|---|--|
| Perit Ivan A. Bondin B.E.&A.(Hons.), M.Sc.(Edin.), A.&C.E. La Pietra, 38, Triq ix-Xieki, Mgabba, MQB 1320. Tel: 21683147 Mob: 79594078 Mail: bondin@onvol.net | Job Description: To convert existing first floor maisonette & overlying airspace into a guest house (Class 3a) to be built on four floors (1st, 2nd, 3rd and 4th floor levels) and a recess floor at 5th floor level. | Scale: 1:100 Drawing Nr. A006_rev01 |
| | Title: Triq Sir W. Reid elevation | 13-06-2018 Drawn by: C.M. |



01

 ELEVATION IN TRIQ C.
 MANCHE AS EXISTING
 SCALE 1:100



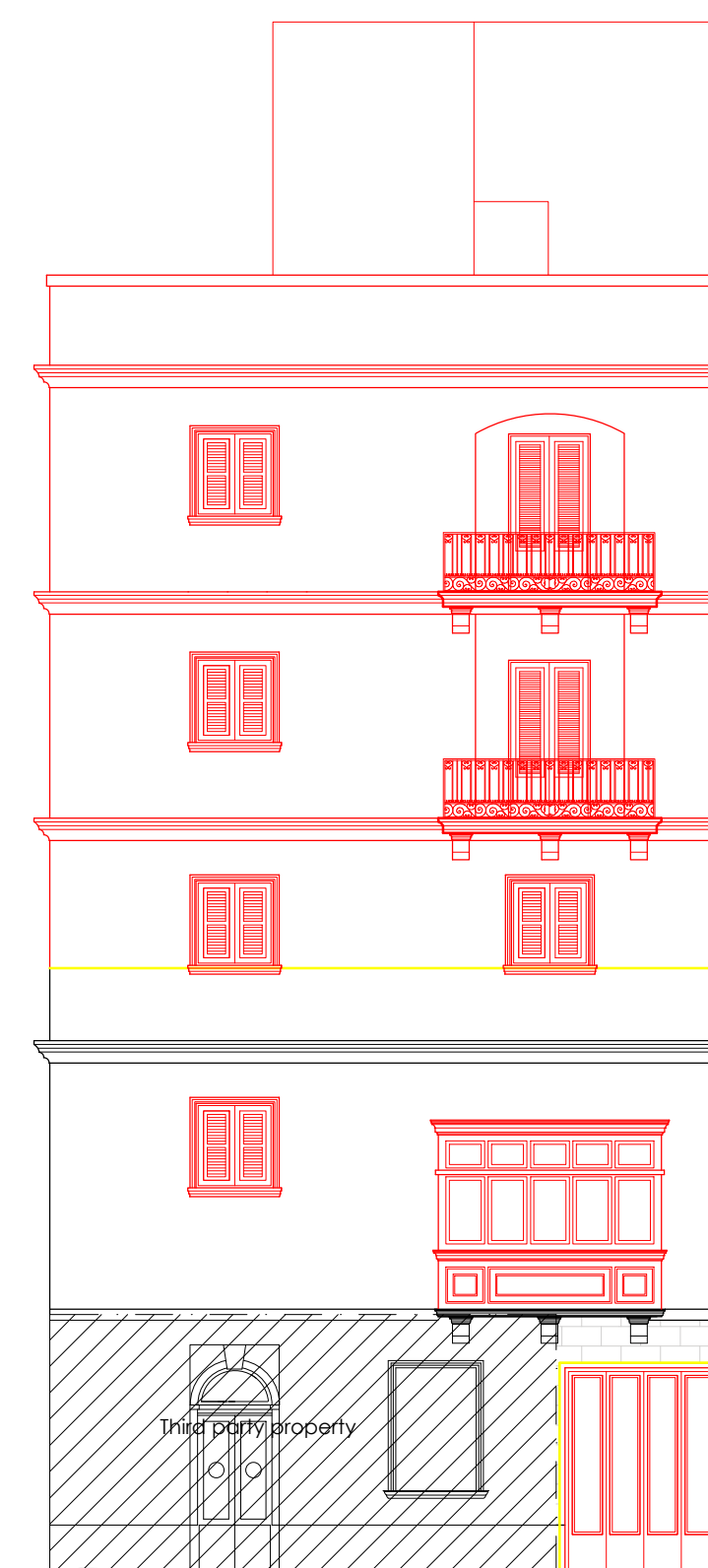

02

 ELEVATION IN TRIQ C.
 MANCHE AS PROPOSED
 SCALE 1:100



03

 ELEVATION IN TRIQ C. MANCHE
 EXISTING VS PROPOSED
 SCALE 1:100

| | |
|---|-----------------------|
|  | Existing to demolish |
|  | Proposed to construct |

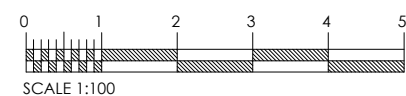

| | | |
|---|---|--|
| Perit Ivan A. Bondin B.E.&A.(Hons.), M.Sc.(Edin.), A.&C.E. La Pietra, 38, Triq ix-Xieki, Mgabba, MQB 1320. Tel: 21683147 Mob: 79594078 Mail: bondin@onvol.net | Job Description: To convert existing first floor maisonette & overlying airspace into a guest house (Class 3a) to be built on four floors (1st, 2nd, 3rd and 4th floor levels) and a reseed floor at 5th floor level. | Scale: 1:100 Drawing Nr. A007_Rev01 13-06-2018 Drawn by: C.M. |
| | Title: Triq C. Manche elevation | |

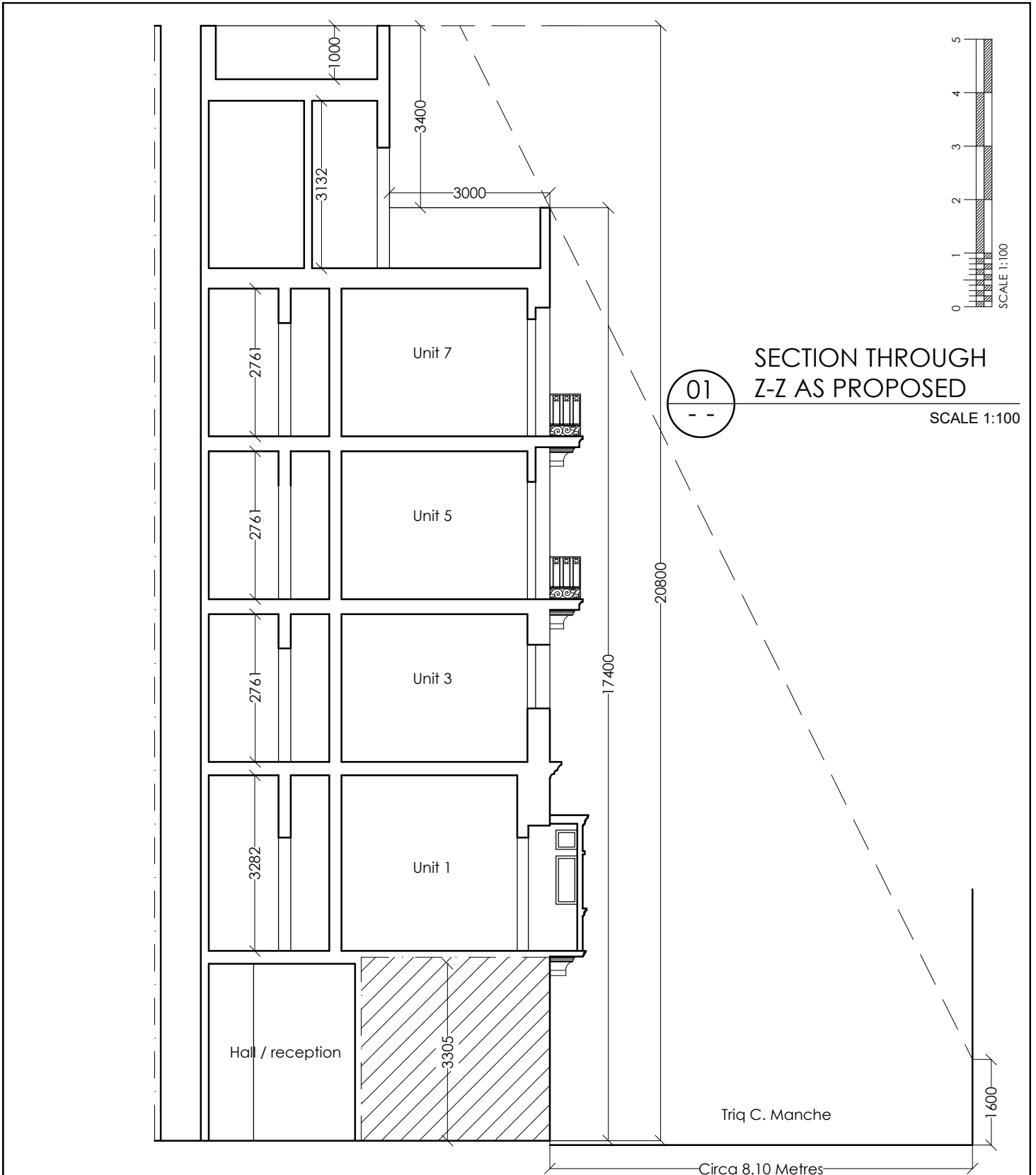

| | | |
|---|--|-------------------------------|
| <p>Perit Ivan A. Bondin</p> <p>B.E.&A.(Hons.), M.Sc.(Edin.), A.&C.E. La Pietà', 38, Triq ix-Xriek, Mgqabba, MQB 1320. Tel: 21683147 Mob: 79594078 Mail: bondin@onvol.net</p> | <p>Job Description: To convert existing first floor maisonette & overlying airspace into a guest house (Class 3a) to be built on four floors (1st, 2nd, 3rd and 4th floor levels) and a reseed floor at 5th floor level.</p> | <p>Scale: 1:100</p> |
| | <p>Title: Section through Z-Z as proposed</p> | <p>Drawing Nr. A008_rev01</p> |
| | | <p>13-06-2018</p> |
| | | <p>Drawn by: C.M.</p> |

Annex Nr 4 – Summary of Calculation

Feasibility Calculation
Reid Street c/w Manche Street, Gzira

Key Features:

| | | | |
|--------------------|--------------|----|-----------------|
| Gross areas | a) Plot area | 61 | |
| Net Areas | Parking | 0 | level -1 |
| | Residential | 0 | level 0 |
| | Residential | 67 | level 1 |
| | Residential | 67 | level 2 |
| | Residential | 67 | level 3 |
| | Residential | 67 | level 4 |
| | Residential | 27 | Penthouse Level |

| | | |
|---------------------|-------------------|---|
| MEPA allows: | a) Full Floors | 4 |
| | b) Receded Floors | 1 |
| | c) Basement | 0 |

| | |
|-----------------------------|---------------------|
| | Total |
| Purchase price | € 280,000.00 |
| Stamp Duty | € 14,000.00 |
| Notary Fees | € 5,600.00 |
| Total Purchase Price | € 299,600.00 |

| PA Fees | Unit | Quantity | Rate (€) | Total |
|------------------------|----------------|----------|------------|------------|
| Commercial | m ² | | | € 4,100.00 |
| Parking contribution | Nr | 2 | € 2,500.00 | € 5,000.00 |
| Car park | m ² | 0 | € 0.00 | € 0.00 |
| Sub Total | | | | € 9,100.00 |
| Total MEPA Fees | | | | |

| Construction & Finishes costs | Unit | Quantity | Rate (€) | Total |
|---|----------------|----------|----------|--------------------|
| Excavation | cm | 0 | 15 | € 0.00 |
| Demolition/alterations | L/S | 1 | 5000 | € 5,000.00 |
| Constuction all floors | m ² | 295 | 165 | € 48,675.00 |
| Finishes car park | m ² | 0 | 0 | € 0.00 |
| Finishes residential | m ² | 0 | 0 | € 0.00 |
| Lift | ls | 0 | 0 | € 0.00 |
| Sub Total | | | | € 53,675.00 |
| Contingency at 10% | | | | € 5,367.50 |
| 18% VAT | | | | € 10,627.65 |
| Cost of Constuction & Finishes | | | | € 69,670.15 |

| Professional Fees | Total |
|---|-------------------|
| 9% of construction (excluding finishes) | € 4,830.75 |
| 18% VAT | € 869.54 |
| Total Architect Fees | € 5,700.29 |

| | |
|----------------------------------|--------------------|
| Total Cost of Constuction | € 75,370.44 |
|----------------------------------|--------------------|

| Finance Costs | Total |
|--|-------|
| Finance at 6% for 0-12 months for 400, 000 | |
| Total Finance Costs | |

| Market Value of Development | Area | Fruitful Units | Unit Value | Estimated resale value |
|---------------------------------|------|----------------|------------|------------------------|
| Garages | | 0 | € 0 | € 0 |
| Commercial premises | | 0 | € 0 | € 0 |
| Maisonette (Ground floor level) | | 0 | € 0 | € 0 |
| Apartments 1 bed | | 0 | € 0 | € 0 |
| Guesthouse in shell form | | 1 | € 550,000 | € 550,000.00 |
| | | 0 | | € 0.00 |
| Total Market Value | | | | € 550,000.00 |
| Estate Agency Fees @ 5.9% | | | | € 32,450.00 |
| Tax | | | | € 44,000.00 |
| Total Resale Value | | | | € 473,550.00 |

| Profits | Total |
|---|---------------|
| Total project cost | € 374,970.44 |
| Total resale value (net of sales commissions) | € 473,550.00 |
| Profits | € 98,579.57 |
| % Profit as a percentage of capital investment | 26.29% |

Annex B - Trust Deed and Pledge Agreement

This Trust Deed is made on the [redacted] of July of the year two thousand and nineteen ([redacted]/07/2019)

BETWEEN:

Of the one part:

K.A. Holdings Limited, a limited liability company registered and incorporated under the laws of Malta bearing company registration number C 56023 and having its registered office situated at 'Project Technik', Canon Road, Qormi QRM 9032, Malta, as duly represented (hereinafter referred to as the "Guarantor");

And

Of the second part:

EMCS International Services Limited, a limited liability company registered and incorporated under the laws of Malta bearing company registration number C 25114 and having its registered office situated at Level 2, Regional Business Centre, University Heights, Msida MSD 1751, Malta, as duly represented hereon, (hereinafter referred to as the "Security Trustee");

And

Of the third part:

KA Finance plc, a public limited liability company registered and incorporated under the laws of Malta bearing company registration number C 91544 having its registered office situated at 'Project Technik', Canon Road, Qormi QRM 9032, Malta, as duly represented (hereinafter referred to as the "Issuer").

WHEREAS:

- A. By virtue of an admission document (hereinafter referred to as the "CAD"), the Issuer intends to issue six million euro (€6,000,000) in value of Bonds, as defined in the CAD, subject to the terms and conditions contained therein;
- B. The Issuer has covenanted that all and any Bonds issued by virtue of the CAD shall constitute the secured obligations of the Guarantor and the security shall be held by a Security Trustee for the benefit of all Bondholders;
- C. The Security Trustee is authorised to act as security trustee thereby holding the security granted or to be granted by the Guarantor on trust for the benefit of all Bondholders.

NOW THEREFORE IT IS AGREED AND DECLARED AS FOLLOWS:

1. DEFINITIONS

- a. In this Deed, unless otherwise defined, the definitions contained in the CAD, as the same may be updated from time to time, shall bear the same meaning herein:

"Act" means the Trust and Trustees Act (Chapter 331 of the Laws of Malta);

"Beneficiaries" means a Bondholder whose interest in the Trust Property is recognised by the Security Trustee by means of an appropriate entry in the register of Bondholders maintained by the CSD, and **"Beneficiary"** shall be construed accordingly;

“BOV Security” means the hypothecary rights emanating from notes of hypothec having inscription numbers I 21688/17, I 21695/17 and I 8672/17;

“Centris II” means the office building still to be developed and built, adjacent to Centris I, being the office building already built and rented out in Triq il-Palazz I-Ahmar in Mriehel;

“Corporate Advisor” means EMCS Ltd, a limited liability company registered and incorporated under the laws of Malta bearding company registration number C 68521 and having its registered address situated at Level 2, Regional Business Centre, University Heights, Msida MSD 1751, Malta or such other person appointed by the Issuer in terms of the Prospects MTF Rules;

“Deed” means this trust deed, as the same may be amended, replaced or updated from time to time;

“Funds” means the funds received by the Issuer following the issuance of the Bonds;

“HSBC Security” means the hypothecary rights emanating from the notes of hypothec having inscription numbers 17557/2010 corrected by 419/2011, 21572/14, 21573/14, 14889/14, 14886/2014;

“Insurance Policy” means the contractor’s all risk policy issued in relation to Centris II by a reputable insurance firm where the total sum insured shall be a minimum of € 4,615,000;

“Obligors” means collectively, the Issuer and the Guarantor;

“Prospects MTF Rules” means the rules issued by the Malta Stock Exchange and regulating the prospects market, in exercise of the powers conferred on it by the Financial Markets Act (Cap. 345 of the Laws of Malta), as the same may be amended from time to time;

“Secured Obligation” means the obligations of the Issuer under the Bonds, in particular the obligation of the Issuer to pay interest and principal as the same may be due in respect of the Bonds, subject to the terms and conditions contained in the CAD;

“Security Documents” means the following documents:

- a) the pledge over the Funds in favour of the Security Trustee, subject to the release contained in Clause 8 of this Deed);
- b) the joint and several suretyship to be granted by the Guarantor in favour of the Security Trustee (the **“Guarantee”**);
- c) the general hypothec to be granted by the Guarantor in favour of the Security Trustee over all its property, present and future;
- d) the special hypothec to be granted by the Guarantor in favour of the Security Trustee over Centris II;
- e) the pledge over the Insurance Policy in favour of the Security Trustee, or annotation to the said Insurance Policy naming the Security Trustee as a beneficiary thereunder; and
- f) such other security documents which may be executed in favour of the Trustee in terms of this deed.

“Security Interest” means the security created in favour of the Security Trustee as a result of the Security Documents and any other real or personal right which the Security Trustee and the Obligors agree at any time to be comprised within the Security Interest for the purposes of this Deed;

“Trust Period” means the period ending on the earlier of:

- a) the day when the Trust Property has been distributed in its entirety;
- b) the day when the Issuer has fulfilled its obligations to pay principal and interest in terms of the CAD;

“Trust Property” means initially the undertaking to grant the Security Interest as stated in Clause 2 of this Deed, and subsequently the rights emanating from this Deed;

- b. Any reference to the Issuer, the Guarantor and/or the Security Trustee includes a reference to its/their duly authorised delegates;
- c. References to Clauses or Recitals are references to clauses or recitals of this Deed;
- d. The headings to the clauses of this Deed are for convenience only and shall not affect the construction or interpretation hereof;
- e. In this Agreement, unless the context otherwise requires, any reference to the singular shall include the plural and vice versa, the use of the masculine pronoun shall include the feminine, the use of the neutral pronoun shall include the masculine or the feminine as the case may be and any reference to any Statute, Law or Regulation having the force of Law or any section thereof includes reference to any modification thereto or re-enactment of such Statute, Law or Regulation having the force of Law for the time being in force;
- f. Capitalised terms used herein shall have the same meaning as set out in the CAD unless the context requires or unless expressly defined herein.

2. UNDERTAKING TO SECURITY TRUSTEE – TRUST PROPERTY

- a. The Guarantor undertakes and binds itself to grant to the Security Trustee the Security Interest in the manner and at the times and under the conditions contained in this Deed and the Security Trustee:
 - i. accepts this undertaking and declares a trust thereon for the benefit of all of the Beneficiaries; and
 - ii. agrees and undertakes to receive the Security Interest on trust for the benefit of all of the Beneficiaries.

3. DECLARATION OF TRUST

- a. Subject to the provisions of this Deed and applicable law:
 - i. The Trust Property is held by the Security Trustee on trust for all the Beneficiaries *pari passu* according to the rights and interests held by each of the Beneficiaries in the Trust Property as evidenced by the register of Bondholders;

- ii. Any sums received by the Security Trustee in case of default by the Issuer of the Secured Obligation and pursuant to the Security Trustee of its rights in the Security Interest shall be received by the Security Trustee on trust to apply them in the following manner:
 - a) Firstly, to indemnities, costs and charges in accordance with this Deed and;
 - b) thereafter to distribute and apply them in accordance with rights and interests of each Beneficiary as set out in this Deed and;
 - c) The remainder to be distributed back to the Issuer.
- iii. The Security Trustee shall make additional declarations of trust whenever additional property is received under this trust and such declarations of trust shall be on the same terms as stated herein and shall form an integral part hereof;
- iv. The trust established under this Deed is to be known as the “KA Trust” or the “Trust”.

4. DEED BINDING ON ALL BENEFICIARIES

- a. The terms and conditions of this Deed shall, upon subscription or purchase of any Bond, be binding upon any Beneficiary as if he had been a party hereto and as if this Deed covenants on the part of each Beneficiary to observe and be bound by all the provisions hereof, and the Security Trustee is hereby authorised and required to do the things required of it by this Deed.

5. BENEFICIARIES

- a. The Issuer hereby agrees to provide the Security Trustee, at any moment in time, with full access to the register of Bondholders thereby providing the Security Trustee with full and unrestricted information in respect thereof. Furthermore, the Issuer hereby undertakes in favour of the Security Trustee that it shall pay all and any charges and levies that may, from time to time, be levied by the central securities depository for the services performed by the same in connection with the Bonds and the register of Bondholders.

6. COVENANTS BY THE GUARANTOR

- a. The Guarantor covenants in favour of the Security Trustee that at all times during the continuance of this Deed:
 - i. it will maintain its corporate existence as a company duly organised and existing and in good standing under the laws of Malta;
 - ii. it will, at all times observe and fully discharge its obligations and undertakings under the CAD;
 - iii. it will, promptly upon the happening of an Event of Default, notify the Security Trustee of such event;

- iv. it shall, at all times and without cost or expense to the Security Trustee, use its best endeavours to, or to cause to, maintain, preserve and keep in proper condition the Security Interest;
- v. the Guarantor will keep proper books of account which shall, at all reasonable times, be open to inspection by the Security Trustee or any person appointed thereby for that purpose, and will furnish to the Security Trustee or any such agent all such information relating to the business or affairs of the Guarantor as they shall require in accordance with International Financial Reporting Standards as adopted by the EU and will deliver to the Security Trustee at least five (5) days before the annual general meeting of the Guarantor each year, a copy of the balance sheet and profit and loss account of the Guarantor certified by the auditors of the Guarantor and copies of the auditors' and directors' report thereon together with copies of any other documents required by law to be attached thereto. The Security Trustee may but shall not be required or bound to carry out any independent audit or other verification of any book of account, balance sheet, profit and loss account, certificates or information furnished to it by the Guarantor;
- vi. the Guarantor shall maintain the Insurance Policy and shall ensure that the Security Trustee is named as beneficiary thereunder;
- vii. the Guarantor shall carry on its business in a proper and efficient manner;
- viii. carry out an independent valuation by a duly qualified expert of any property owned by itself at the Guarantor's expense and shall cause to furnish such evaluation to the Security Trustee upon the instruction of the Security Trustee and;
- ix. the Guarantor shall forthwith on receipt of same, deliver to the Security Trustee all orders, directions, notices and other things whatsoever affecting or likely to adversely affect the Security Interest and the Guarantor shall be entitled to retain a copy thereof, at its own expense.

7. REPRESENTATIONS AND WARRANTIES

- a. Each of the Obligors represent and warrant in favour of the Security Trustee that relies upon such representations and warranties, that, for the duration of the Deed:
 - i. they are duly incorporated and validly registered under the laws of Malta and have the power to carry on their business as it is now being conducted and to hold their property and other assets under legal title;
 - ii. they have the power to execute, deliver, and perform their obligations under this Deed;
 - iii. all necessary corporate action has been duly taken to authorise the execution, delivery and performance of the same;
 - iv. this Deed constitutes the legally valid and binding obligations of the Guarantor and the Issuer;

- v. the execution of the Deed and the performance of the Guarantor's and Issuer's obligations hereunder do not (a) contravene any existing applicable law, statute, rule or regulation or any judgment, decree or permit to which the Guarantor or the Issuer are subject, (b) conflict with, or result in any breach of any terms of, or constitute a default or acceleration event under any bond or other instrument to which the Guarantor or the Issuer is a party or is subject or by which it or its property is bound, (c) contravene any provisions of the Guarantor's or Issuer's memorandum and articles of association;
- vi. no litigation, arbitration or administrative proceedings are pending or, to the knowledge of the Guarantor or the Issuer, threatened against the Guarantor or the Issuer which could have a material adverse effect on their business, assets or financial condition;
- vii. the CAD contains all material information with respect to the Guarantor and the Issuer and all information contained therein is, in every material respect, correct and true and not misleading and there are no facts in relation to the Guarantor and Issuer, their respective businesses and financial position, the omission of which would, in the context of the Issue make any statement made in the CAD misleading or inaccurate in any material respect;
- viii. no Event of Default has occurred and is continuing;
- ix. the Issuer shall perform the Secured Obligations.

8. ISSUANCE OF BONDS

- a. The Guarantor undertakes that within [-] Business Days from the issuance of the Bonds, it shall procure the cancellation of the HSBC Security and postponement / waiver of the BOV Security in favour of the Security Trustee (acting as trustee in terms of this Trust). Until such time as the Issuer procures such cancellation or postponement, the Issuer shall be required to pledge, or procure that a pledge be created over, the Funds in favour of the Security Trustee, which security shall form part of the Security Interest.
- b. Simultaneously with the cancellation of the HSBC Security and postponement / waiver of the BOV Security, in each case in favour of the Security Trustee (acting as trustee in terms of this Trust), the pledge created on the Funds shall be cancelled and the Security Trustee shall be obliged to transfer the Funds to the Issuer (or its delegate) to such local bank account indicated by the Issuer. All bank charges related to the release of the Funds shall be borne by the Issuer.

9. POWERS AND FUNCTIONS

- a. The Security Trustee shall, in addition and without prejudice to all statutory powers, have the powers and immunities set out in this Deed. No power conferred on the Security Trustee shall be exercised so as to conflict with the beneficial provisions of this Deed.
- b. The Trustee shall not distribute to or hold all or any of the Trust Property for the benefit of any person who is not a Beneficiary.

- c. The Security Trustee may, in its absolute discretion and without further notice, enforce or take any step or proceedings to enforce the covenants and provisions in this Deed, and may in its absolute and uncontrolled discretion waive on such terms and conditions as it shall deem expedient any of the covenants and provisions contained in this Deed and/or the Pledge Agreement to be performed and observed on the part of the Guarantor or the Issuer. The Security Trustee may but shall not be bound to take any such steps or proceedings to enforce the said covenants and provisions unless requested to do so in writing by not less than 60% in value of the Beneficiaries. The Beneficiaries shall hold the Security Trustee harmless and fully indemnified for and against any loss, damage, cost or other liability it may incur by virtue of its failure to enforce or take any steps or proceedings to enforce the covenants and provisions in this Deed in the event that it has not received proper instructions in writing from at least 60% in value of the Beneficiaries.
- d. The Security Trustee shall have the power, but shall have no obligation, to monitor financial information relating to the Guarantor or the Issuer, on behalf of the Beneficiaries, as may be forwarded to the Security Trustee by the Guarantor or the Issuer on an annual basis.
- e. The Security Trustee may, at any time during the Trust Period, accept (but shall not be bound to so accept) additional money, investments or other property of whatever nature and wherever situated, paid or transferred to it by any person. Such additional money, investments or other property shall be held upon trust with and subject to the powers and provisions of this Deed.
- f. The Security Trustee shall have the powers and discretions granted to it pursuant to the Pledge Agreement and any other document relating to or regulating the Security Interest.
- g. Without prejudice to the powers and the reliefs conferred upon trustees under applicable law, the Security Trustee shall have the following powers:
 - i. The Security Trustee may employ and pay, at the expense of the Guarantor or the Issuer, any agent in any part of the world to transact any business in connection with this Trust without being responsible for the fraud, dishonesty or negligence of such agent if employed in good faith;
 - ii. The Security Trustee may hold all or any part of the Trust Property in the name of any person or partnership, as nominee, on such terms as the Security Trustee thinks fit;
 - iii. The Security Trustee may engage any person or partnership to manage the Trust Property without being liable for any consequent loss;
 - iv. The Security Trustee may, without being liable for any consequent loss, delegate to any person the operation of any bank or other account;
 - v. The Security Trustee may, by deed revocable or irrevocable, delegate to another trustee or any other person the exercise of all or any Trust and powers conferred on such trustee (other than the power of delegation conferred by this sub-Clause) notwithstanding the fiduciary nature of such trusts and powers;
 - vi. To delegate, whenever it thinks fit, any of its powers and discretions under this Deed to any person/s (including but without limitation, any officer/employee/agent of the Security Trustee) believed by it to be competent and responsible and to delegate all or any of the trust powers and duties vested in it under this Deed to such person/s (including any such

officer/employee/ agent as aforesaid) as it shall think fit without incurring any liability for the default of any person to whom such discretions, powers or duties are delegated;

- vii. The Security Trustee may rely on the advice, opinion, direction, report, statement, certificate or other information by any advocate, broker, surveyor, valuer, accountant, auditor or other professional person without incurring any liability for so relying notwithstanding that such professional person may have been employed by the Guarantor or the Issuer or may otherwise not be disinterested and without incurring liability for any error in the transmission of any such advise, opinion, direction, report, statement, certificate or other information, or by reason of the same not being authentic. The Security Trustee may but shall not be bound to make any investigation or inquiry into any matters stated in such advice, opinion, direction, report, statement, certificate or other information;
- viii. The Security Trustee shall be under no obligation to insure any of the Trust Property or any deeds, documents of title, certificates, bonds or other evidence in respect thereof, and it shall be within the absolute discretion of the Security Trustee to require any other person to maintain any such insurance;
- ix. The Security Trustee shall be empowered to execute any document for the constitution of the Security Interest for the benefit of the Beneficiaries. Until the end of the Trust Period, the Security Trustee shall be empowered to carry out any transaction and to execute any such document required pursuant to and/or conducive to the Security Interest, including but not limited to, any amendment thereto and waiver to any terms thereof.

10. FINANCIAL TRANSACTIONS BY SECURITY TRUSTEES

- a. Neither the Security Trustee nor any director, officer or employee of the Security Trustee shall, by reason of the fiduciary position of such Security Trustee, be in any way precluded from making any commercial contracts or entering into any commercial transactions with the Guarantor or the Issuer and/or any of their shareholders or beneficiaries, whether directly or through any subsidiary or associated company, or from accepting the trusteeship of any other debenture stock, debentures or securities of the Guarantor or the Issuer, and without prejudice to the generality of these provisions it is expressly declared that such contracts and transactions include any contract or transaction in relation to the placing, underwriting, purchasing, subscribing for or dealing with or lending money upon or making payments in respect of any stock, shares, debenture stock, debentures or other securities of the Guarantor or of the Issuer or any contract of banking or insurance with the Guarantor or the Issuer and neither the Security Trustee nor any such director, officer or employee shall be accountable to the Beneficiaries for any profit, fees, commissions, interest, discounts or share of brokerage earned, arising or resulting from any such contracts or transactions, and the Security Trustee and any such director, officer or employee shall also be at liberty to retain the same without accounting therefor.

11. ACKNOWLEDGEMENT OF SECURITY

- a. The execution of this Deed by the Security Trustee and the publication in summarised form of the salient features incorporated within this Deed in the CAD shall constitute notice to each of the Beneficiaries of the security created in favour of the Beneficiaries.

12. PROCEDURE UPON EVENT OF DEFAULT

- a. In the Event of a Default, the Security Trustee may, in its absolute and unfettered discretion, and shall, upon the request in writing of not less than 60% in value of the Bondholders qua primary beneficiaries and/or of the Corporate Advisor acting in its duty of care to the Exchange, the market and the Bondholders, by notice in writing to the Issuer and the Guarantor and copied to the Security Trustee, declare the Secured Bonds to have become immediately due and repayable at their principal amount, together with any accrued interest.

Provided that in the event of any breach by the Issuer of any of the covenants, obligations or provisions herein contained due to any fortuitous event of a calamitous nature, beyond the control of the Issuer, ("**Force Majeur Event**") the Security Trustee may, but shall be under no obligation to do so, give the Issuer such period of time to remedy the breach as in its sole opinion may be justified in the circumstances and if in its sole opinion the breach is remediable within the short term and without any adverse impact on the Beneficiaries. Provided that, in the case of a Force Majeur Event, the Security Trustee shall at all times act on and in accordance with any instructions it may receive from Bondholders holding not less than 60% in value of the Bonds.

- b. The Security Trustee shall not be bound to take any steps to ascertain whether any Event of Default or other condition, event or circumstance has occurred or may occur, and, until it shall have actual knowledge or express notice to the contrary, the Security Trustee shall be entitled to assume that no such Event or condition, event or circumstance has happened and that the Issuer is observing and performing all the obligations, conditions and provisions on its part contained in the CAD and this Deed.

Provided further that, in the event that the Security Trustee becomes aware of the fact that an Event of Default has occurred or is likely to occur, it shall notify in writing the Malta Stock Exchange, the Corporate Advisor and the Bondholders of such fact without delay.

- c. All monies received or recovered by any of the Beneficiaries after the occurrence and during the continuance of an Event of Default shall be held on trust for the Security Trustee and be applied by the Security Trustee in favour of the Beneficiaries *pari passu* according to the rights and interests held by each Beneficiary in the Trust Property as evidenced by the register of Bondholders.
- d. The Beneficiaries acknowledge that the Security Trustee shall not be bound to take any steps or institute any proceedings or to take any other action to enforce the security constituted by the Security Interest unless the Security Trustee shall have been indemnified to its satisfaction against all actions, proceedings, claims and demands to which it may thereby render itself liable and all costs, charges, damages and expenses which it may incur by so doing.

- e. The Security Trustee shall be entitled to make deductions and withholdings (on account of taxes or otherwise) from payments to the Beneficiaries hereunder which it is required by any applicable law to make, and to pay all taxes which may be assessed against it in respect of the Security Interest, in respect of anything done by it in its capacity as trustee or otherwise by virtue of its capacity as trustee. Neither the Issuer nor the Security Trustee shall be under any obligation to pay any additional amounts in the event of a withholding or deduction required by applicable law and the Secured Obligations shall be discharged upon receipt by the Beneficiaries of such amounts as are due to them but subject to any valid withholdings or deductions having been made from such amounts.

13. DISTRIBUTION BY SECURITY TRUSTEE

- a. All monies arising from any calling in or collection hereunder and all monies received by the Security Trustee hereunder at any time shall be held by the Security Trustee (subject to any prior ranking claims thereon, if any) upon trust to apply the same for the following purposes and in the following order of priority in payment of:
 - i. All costs, charges, expenses and liabilities incurred and payments made in or about the exercise of the trust in relation to this Deed by the Security Trustee including all remuneration payable to the Security Trustee with interest thereon as hereinafter provided;
 - ii. The interest owing upon the Bonds *pari passu* and without any preference or priority;
 - iii. The principal monies owing upon the Bonds *pari passu* and without any preference or priority.
- b. The Security Trustee shall give to the Beneficiaries at least ten (10) days' notice of every distribution made by it to the Beneficiaries. The Security Trustee shall be entitled, at its discretion, to withhold payment of any monies due to be distributed to any Beneficiaries. Any monies the payment whereof is for the time being withheld by the Security Trustee pursuant to this Clause shall be placed by it at the risk of the person or persons entitled thereto in a savings account with a bank. The amount which equals the amount of any principal monies for the time being withheld from the person or persons registered or entitled to be registered as the Beneficiaries of the Bonds shall not carry interest while such monies are being withheld (save any interest allowed on the savings account in which such monies are placed). The receipt of the Bondholder or of the first named joint Bondholders for any monies paid by the Security Trustee in respect of the Bonds shall be a good discharge to the Security Trustee for those monies.

14. MEETINGS OF BENEFICIARIES

- a. The Security Trustee at any time and at the cost of the Issuer prior to exercising any power or discretion hereunder may:
 - i. Call a meeting of Beneficiaries by giving such Beneficiaries not less than seven (7) days' notice in writing setting out in the notice the time, place and date set for the meeting and the matters to be discussed thereat; or
 - ii. Write to all Beneficiaries requesting their instructions or directions.

Provided that the Security Trustee shall not be liable for any action it may deem necessary to take prior to acting in accordance with paragraphs 14.a.i or 14.a.ii.

- b. In the event that there are more than two (2) Beneficiaries at any meeting of Beneficiaries, two persons present in person or by proxy shall constitute a quorum. Unless this Deed otherwise determines, all decisions taken at meetings of Beneficiaries shall be passed by simple majority of those present and voting.
- c. Upon request made at any time by Beneficiaries holding at least ten per cent (10%) of the outstanding value of the Bonds, the Security Trustee shall call a meeting of Beneficiaries.
- d. The Security Trustee shall not be bound to act on behalf of the Beneficiaries under this Deed unless it receives duly authorised instructions or directions as stipulated in this Deed.
- e. Nothing in this Deed shall be construed as meaning that the Security Trustee is bound to act in the manner specified in this Clause unless so required by this Deed.

15. RESTRICTIONS ON EXERCISE OF CERTAIN RIGHTS

- a. The Security Trustee and the Issuer note that in terms of the CAD, the Bondholders agree not to exercise any right of set-off in respect of any amount payable to by the Bondholders to the Issuer against any amount payable by the Issuer to the Bondholders.

16. PROTECTION OF THE TRUSTEE GENERALLY

- a. The Security Trustee shall not be liable for any default or breach of duty or trust committed by its act or omission or that of any of the former or current trustee or any of the Security Trustee's agents or advisers or for any loss or depreciation in value or loss of profits howsoever caused which may be suffered in respect of the capital or income of the Trust Property, unless such default or breach is, or such loss or depreciation in value or loss of profit is caused by:
 - i. fraud, wilful misconduct or gross negligence on the part of the Security Trustee which is sought to be made liable; and/or
 - ii. some act or omission in respect of which that Security Trustee cannot under the applicable law for the time being of this Deed lawfully be exonerated from personal liability by the terms of this Deed. The Security Trustee shall not be liable for any error of judgment committed in good faith unless it shall be proved that it was grossly negligent in ascertaining the pertinent facts.
- b. The Security Trustee, (which shall include each director, employee, shareholder, delegate and agent thereof) shall be indemnified out of the Trust Property against:
 - i. any liability incurred by him in defending any proceedings in connection with his duties as a Security Trustee, in which judgement is given in his favour or in which he is acquitted; and
 - ii. against all claims, liabilities, costs, damages and expenses (including legal fees) to which it may be or become subject by reason of its activities as Security Trustee so long as the said activity or circumstance does not involve fraud or wilful misconduct or gross negligence on the part of the Security Trustee;

- c. The Security Trustee may purchase and maintain insurance, to the extent and in such a manner in its absolute discretion it deems appropriate, on behalf of itself, against any liability that may be asserted or expenses that may be incurred by any such person in connection with the activities of the Trust, regardless of whether the Security Trustee has the right to be indemnified out of the Trust Property under the provisions of the Trust or by law.

17. RELEASE OF POWERS

- a. The Security Trustee may by deed (and so as to bind successive trustees of this Trust) release or restrict the future exercise of all or any of the powers conferred on it by this Trust.

18. INFORMATION TO BENEFICIARIES

- a. The Security Trustee shall, so far as is reasonable and within a reasonable time of receiving a request in writing to that effect, provide full and accurate information as to the state and amount of the Trust Property, including the accounts of the Trust.

19. REMUNERATION TO SECURITY TRUSTEE

- a. During the continuance of this Deed, the Security Trustee shall be entitled to receive and the Issuer and the Company shall be jointly and severally liable to pay such reasonable remuneration as they may agree in writing between them. The Security Trustee shall be entitled to be indemnified for all reasonable costs and expenses incurred in carrying out the Trust.

20. RESIGNATION OF SECURITY TRUSTEE AND APPOINTMENT OF NEW OR ADDITIONAL TRUSTEE

- a. Subject to the provisions of article 20(2) of the Act, the Security Trustee may resign as Security Trustee by giving not less than three (3) months' notice in writing to the Guarantor and the Issuer without assigning any reason whatsoever and without being responsible for any costs occasioned by such retirement.
- b. The Bondholders shall have the power exercisable by a resolution passed at a meeting of Bondholders passed by sixty per cent (60%) in value of the Bondholders to remove the Security Trustee.
- c. The Guarantor undertakes that in the event of the Security Trustee giving notice, or being removed, under this Clause it will use all reasonable endeavours to procure a new trustee to be appointed. The retirement or removal shall not become effective until such time as a successor trustee is appointed.
- d. The Obligors undertake that, in the event of the Security Trustee giving notice, or being removed, under this Clause 20 they will use all reasonable endeavours to procure a new trustee to be appointed. Should a successor trustee not be appointed within thirty (30) days subsequent to the delivery of the notice of resignation by the Security Trustee or the date of removal of the Security Trustee, the Security Trustee may itself appoint a successor trustee. The retirement or removal shall not become effective until such time as a successor trustee is appointed and the Trust Property is transferred to the successor trustee.

- e. The Security Trustee shall, at its own cost, make available to the successor trustee such documents and records and provide such assistance as the successor trustee may reasonably request for the purpose of performing its functions as the trustee of the Trust Property for the benefit of the Beneficiaries of this Deed.
- f. Upon the appointment of a successor trustee, the resigning Security Trustee shall be discharged from any further obligation in terms of this Deed. The successor trustee, the Beneficiaries, the Issuer and the Guarantor shall have the same rights and obligations as they would have had if such successor trustee had been an original party to this Deed.

21. TERMINATION

- a. The Security Trustee shall only be discharged from all liabilities and obligations which it has under this Deed upon the redemption on the Maturity Date of the principal amount of the Bonds and payment of all interest thereunder and re-imburement of all expenses incurred by, and payment of, remuneration due to the Security Trustee under this Deed.

22. EXCLUSION OF IMPLIED DUTIES

- a. The Security Trustee shall not have or incur any obligation, duty or responsibility, whether fiduciary or otherwise, to the Guarantor or the Issuer or to any of the Beneficiaries, as the case may be, except those expressly specified in this Deed and the Bonds to the effect that the Security Trustee has such a duty or responsibility.

23. AMENDMENTS TO THIS DEED

- a. The Trustee may at any time or times during the Trust Period by deed or deeds and without the prior written consent of the Beneficiaries, vary, amend, add to or delete any or all of the provisions of this Deed (whether of a beneficial or administrative nature) including the trusts, powers and discretions and the administrative powers herein declared and contained provided that:
 - i. no such variation, amendment, addition or deletion shall infringe the applicable law of this Deed; and
 - ii. no such variation, amendment or addition shall be permitted to the provisions of this Clause 23, but it shall be permissible to delete this Clause in its entirety.

24. APPLICABLE LAW, FORUM AND PLACE OF ADMINISTRATION

- a. The applicable law of this Deed shall be that of Malta. All rights under this Deed and its construction and effect shall be subject to the jurisdiction of the courts, and construed according to the laws, of Malta.
- b. The courts of Malta shall be the forum for the administration of these trusts.

| | |
|--|--|
| <p>_____</p> <p>Mr Kurt Abela For and on behalf of K.A. Holdings Limited</p> | <p>_____</p> <p>Ms Geraldine Schembri For and on behalf of EMCS International Services Limited</p> |
| <p>_____</p> <p>Mr Stefano Mallia For and on behalf of EMCS International Services Limited</p> | <p>_____</p> <p>Mr Etienne Borg Cardona For and on behalf of KA Finance plc</p> |
| <p>_____</p> <p>Mr John Soler For and on behalf of KA Finance plc</p> | |

This Pledge Agreement is made on the [REDACTED] of August of the year two thousand and nineteen ([REDACTED].08.2019)

BETWEEN:

Of the one part:

K.A. Holdings Limited, a limited liability company registered and incorporated under the laws of Malta bearing company registration number C 56023 and having its registered office situated at 'Project Technik', Canon Road, Qormi QRM 9032, Malta, as duly represented, (hereinafter referred to as the "**Guarantor**");

And

Of the second part:

EMCS International Services Limited, a limited liability company registered and incorporated under the laws of Malta bearing company registration number C 25114 and having its registered office situated at Level 2, Regional Business Centre, University Heights, Msida MSD 1751, Malta, as duly represented, (hereinafter referred to as the "**Pledgee**");

And

Of the third part:

KA Finance plc, a public limited liability company registered and incorporated under the laws of Malta bearing company registration number C 91544 having its registered office situated at 'Project Technik', Canon Road, Qormi QRM 9032, Malta, as duly represented, (hereinafter referred to as the "**Pledgor**");

And

Of the Forth part:

Curmi and partners, a limited liability company registered and incorporated under the laws of Malta bearing company registration number C3909, and having its registered office situated at Finance House, Princess Elizabethta, Ta' Xbiex XBX 1102, Malta, as duly represented, (hereinafter referred to as the "**Manager**");

(The Guarantor, the Pledgee, the Pledgor and the Manager each being referred to as "**The Party**" and collectively referred to as the "**Parties**".)

WHEREAS

- A. By virtue of a company admission document dated [-], as supplemented from time to time (the "**CAD**") the Pledgor has issued six million euro (€6,000,000) in value of Bonds, as defined in the CAD;
- B. On the [-], the Pledgor, the Guarantor and the Security Trustee entered into a trust deed (the "**Trust Deed**") whereby the Guarantor undertook and bound itself to grant to the Security Trustee the Security Interest in the manner and at the times and under the conditions contained in the said Trust Deed;

- C. The Security Trustee is authorised to act as security trustee thereby holding the security granted or to be granted by the Guarantor on trust for the benefit of all Bond Holders;
- E. In terms of the said Trust Deed, the Pledgor has undertaken that within [-] Business Days from the issuance of the Bonds, it shall procure the cancellation of the HSBC Security and postponement / waiver of the BOV Security in favour of the Security Trustee (acting as security trustee);
- F. On the [-] 2019, the Pledgor issued the Bonds and for this purpose the Manager has opened the account bearing number [-] (Currency: Euro) under the instruction of the Pledgee with the sole purpose that the Funds shall be deposited therein, hereinafter the **“Account”**;
- G. The Parties are therefore entering into this Agreement so as to establish the terms and conditions under which the pledging of the Account shall take place and under which the release and termination of such pledge shall be affected.

NOW THEREFORE IT IS AGREED AND DECLARED AS FOLLOWS:

1. DEFINITIONS

- a. Unless the context otherwise requires, terms used in this Agreement have the same meanings as in the CAD, as may be supplemented from time to time, and the Trust Deed (hereinafter jointly referred to as the **“Transaction Documents”**).
 - i. **“Bank”** means
 BANK OF VALLETTA LIMITED, NAXXAR ROAD, SAN GWANN, MALTA
 SORT CODE: 22677
 SWIFT: VALLMTMT
 IBAN NOS. EUR - MT41VALL22013000000040012392478
 FOR CREDIT OF A/C NO.: 40012392478 EUR CURRENT
 IN THE NAME OF: CURMI & PARTNERS LIMITED – CLIENTS ACCOUNT
 - ii. **“Property”** means Centris II means the office building still to be developed and built, adjacent to Centris I, being the office building already built and rented out in Triq il-Palazz I-Ahmar in Mriehel;
 - iii. **“Transferor”** means Project Technik Limited, a limited liability company registered and incorporated under the laws of Malta, bearing company registration number C 48668 and having its registered office situated at ‘Project Technik’, Cannon Road, Qormi, QRM 9032, Malta.
- b. In this Pledge,
 - i. the headings are used for guidance only;
 - ii. any reference to a person includes a body corporate, company, partnership, society, firm or any individual, and in the case of an individual, his heirs, testamentary executor, curator, administrator or receiver, and any other person lawfully acting on behalf of every such person;

- iii. any reference to any law or statute, or any section of any law or statute, includes reference to any modification or re-enactment of it for the time being having the force of law;
- iv. references to the singular include the plural and vice versa;
- v. references to the masculine gender include the feminine gender and vice versa.

2. PLEDGE

- a. The Manager hereby confirms that it holds the Account and all funds deposited therein for the benefit of and in the interests of the Pledgor.
- b. The Pledgor hereby pledges to the Pledgee (for avoidance of doubt, in its capacity as Security Trustee in terms of the Trust Deed), which accepts, the Account and all funds deposited therein (which for the avoidance of doubt includes the Funds to be deposited therein as a result of the issuance of the Bonds) and all related rights as security for the due and punctual performance of the Secured Obligations. The parties are entering into this Agreement to regulate the Pledge.
- c. It is expressly agreed that the Pledge is being granted by the Pledgor to the Pledgee as security for the performance in full of the Secured Obligations.
- d. In constitution of the said pledge, the Pledgor is placing the Account under the full control of the Pledgee and accordingly the Pledgee shall exercise full control over the Account for the duration of this Agreement and the Manager hereby consents to the same.
- e. In constitution of the Pledge, the Pledgor makes the representations, warranties and covenants herein set out, below, the Pledgor is placing the Account under the full control of the Pledgee.
- f. During the duration of this Agreement, any banking mandate on the Account given to the Bank is suspended to the extent stated herein.
- g. The Manager confirms that, for as long as the Pledge is in place, it shall recognise the rights of the Pledgee over the Account and shall comply with terms of this Agreement.
- h. This pledge confers upon the Pledgee the right to obtain payment out of the Account with privilege over other creditors as provided by the Civil Code (Chapter 16 of the Laws of Malta) in virtue of the special privilege accorded by law under Article 2009(a) of the said Code.
- i. The Parties hereby agree that this Pledge Agreement constitutes a 'financial collateral arrangement' as defined in the Financial Collateral Arrangements Regulations, Subsidiary Legislation 459.01 (the "**Regulations**") and that the Regulations shall be applicable to this Pledge Agreement.
- j. The Pledgee holds the benefit of this Agreement on trust for the Bondholders in accordance with the provisions of the Trust Deed.
- k. The Manager shall notify in writing the Bank that the Account and all funds deposited therein have been pledged in favour of the Pledgee and that the use of the Account shall be limited by virtue of this Agreement, in particular by virtue of Clause 4.f of this Agreement.

3. PLEDGOR AND MANAGER WARRANTIES AND UNDERTAKINGS

- a. The Pledgor undertakes and warrants that:
 - i. the entry into and performance of, and the transactions contemplated by, this Agreement does not and will not:
 - (aa) conflict with any law or regulation or judicial or official order; or
 - (bb) conflict with its constitutional documents; or

- (cc) conflict with any document which is binding upon its or any of the Pledgee's assets;
 - ii. this Pledge and all the terms and obligations herein contained are valid and binding and there exist no limitations in any agreement to which the Pledgor is a party or in any applicable law which would hinder the performance of any of his obligations in this Pledge; and
 - iii. at any time and from time to time upon the written request of the Pledgee, he will promptly and duly execute and deliver to the Pledgee all and any such further documents as the Pledgee may deem necessary for obtaining the full benefit of this Pledge and of the rights and powers granted in this Pledge.
 - iv. The undertakings and warranties in this Pledge will be true and accurate throughout its duration with reference to the facts and circumstances subsisting from time to time.
- b. The Manager undertakes and warrants that:
- i. the entry and performance of, and the transactions contemplated by, this Agreement does not and will not:
 - (aa) conflict with any judicial or official order; or
 - (bb) conflict with its constitutional documents; or
 - (cc) conflict with any document which is binding upon its or any of the Pledgee's assets and;
 - ii. The undertakings and warranties of the Manager in this Agreement will be true and accurate throughout its duration with reference to the facts and circumstances subsisting from time to time.

4. COVENANTS

For the duration of this Pledge, each of the Pledgor and the Manager covenant and agree with the Pledgee:-

- a. that the Manager will remain the legal owner of the Account and that the Pledgor will remain the beneficiary of the Account;
- b. to warrant and to defend its right title and interest and that of the Pledgee in and to the Account against the claims and demands of all persons whomsoever;
- c. that it will not, without the prior written consent of the Pledgee sell, assign, transfer, pledge or encumber in any other manner the Account or suffer to exist any encumbrance on the Account except the Pledge;
- d. that it will not grant in favour of any other person any interest in or other rights in respect of the Account;
- e. that it will obtain and maintain in full force and effect all governmental and other approvals and consents and do or cause to be done all other acts and things necessary or desirable in connection herewith or for the obligations hereunder;
- f. that it shall comply in all respects with all laws and regulations to which it may be subject, if failure so to comply would materially impair its ability to perform its obligations under this Agreement.

5. USE OF ACCOUNT

- a. The Account shall be used strictly in accordance with this Agreement as the same may from time to time be modified or substituted with the consent of both parties.
- b. All rights to give instructions to the Bank including instructions relating to or connected with payments from the Account, including without limitation payments of interest and repayment of principal and/or any balances, shall be directed by the Pledgee.
- c. It is agreed that the right to close the Account shall not at any time be exercisable by the Pledgor or the Manager without the express written consent of the Pledgee.
- d. It is agreed that monies standing to the credit of the Account under this Pledge Agreement shall be, in part, applied by the Pledgee in the manner set out in Clause [6] hereunder.

6. TERMINATION OF THE PLEDGE

- a. Pursuant to the CAD and the Trust Deed, the Pledgor undertook to, within [-] Business Days from the issuance of the Bonds, procure the following:
 - i. [insert cancellation/postponement of BOV and HSBC security]; and
 - ii. [insert transfer of property](the “**Security Cancellation and Property Transfer**”).
- b. Simultaneously with the
 - i. Security Cancellation and Property Transfer,
 - ii. the satisfaction by the Pledgor and/or by the Guarantor of the Secured Obligation:

whichever is the earlier, the Pledgor and the Manager shall be automatically released from the Pledge under this Agreement and the Pledge shall be automatically terminated and the Account, the funds deposited therein and the related rights shall be at the complete and free disposal of the Pledgor. The Pledgee undertakes to, within [5] Business Day of the termination of the Pledge, notify the Bank of the termination of the Pledge.

7. REMEDIES

- a. On the occurrence of an Event of Default, the Pledgee may exercise in relation to the Account all the rights and remedies possessed by it under this Agreement or granted to it by law or otherwise, including without limitation, the right to set off the amount held in the Account against or to apply it in order to repay the Bondholders in accordance with the provisions of the Regulations.
- b. These remedies are in addition to the remedies granted to the Pledgee under any applicable law and, in so far as it is necessary to do so, the Pledgor and the Manager authorises the Pledgee to avail itself of all and any of the rights and/or remedies in the exercise and protection of its rights contained in this pledge agreement.
- c. No failure to exercise, nor any delay in exercising, on the part of the Pledgee, any right or remedy under this Agreement shall operate as a waiver, nor shall any single or partial exercise of any right or remedy prevent any further or other exercise or the exercise of any other right or remedy. The rights and remedies provided in this Agreement are cumulative and not exclusive of any rights or remedies provided by law.

8. IRREGULARITIES IN OTHER SECURITIES – INCAPACITY – INDEMNITY

- a. This Agreement shall not be extinguished, discharged or otherwise effected by the total or partial invalidity or unenforceability or any irregularity or defect in any security (whether by way of mortgage, hypothec, pledge, guarantee, indemnity or otherwise) the Pledgee may now or at any time hold. The Pledgor hereby agrees to promptly indemnify the Pledgee against any cost, loss or liability incurred by it as a result of:
- i. the taking, holding, protection or enforcement of the Pledge;
 - ii. the exercise of any of the rights, powers, discretions and remedies vested in the Pledgee by this Agreement or by law; and
 - iii. any default by the Pledgor in the performance of any obligations expressed to be assumed by it in this Agreement.
- b. The Pledgor shall on demand pay, on a full indemnity basis, all costs, charges, fees and expenses in any way incurred by the Pledgee in or incidental to the preservation or enforcement of this Agreement and on any payment to the Pledgee such payment shall be appropriated to such costs prior to being appropriated to interest and then principal due.

9. FURTHER ASSURANCES AND AGREEMENTS

- a. The Pledgor and the Manager agree that at any time and from time to time upon the written request of the Pledgee, they will promptly and duly execute and deliver to the Pledgee any and all such further instruments and documents as the Pledgee may deem necessary for obtaining the full benefit of this Agreement and of the rights and powers herein granted or perfecting the security created hereunder.

10. NOTICE TO THIRD PARTIES

- a. Each of the Pledgor and the Manager shall, if requested to state the position of its accounts, inform third parties of the Pledge and shall not represent in any way that it has free use of the Account.

11. ATTORNEY

- a. Subject to any limitations expressed elsewhere in this agreement, each of the Pledgor and the Manager hereby irrevocably appoints the Pledgee as its true and lawful attorney for the purpose of carrying out the provisions of this contract and taking any action or executing any instruments which the Pledgee may deem necessary to accomplish the purposes hereof. This appointment as attorney is being given as part of this security.
- b. Notwithstanding the foregoing appointment, the Pledgee shall have the option but not an obligation to utilise such power of attorney and the Pledgor shall in no way be responsible for not utilising the said power of attorney nor shall the Pledgee be in any way responsible for anything done in virtue of the said power of attorney.

12. NOTICES

- a. Any demand, notice or proceeding under this Pledge may be served:
 - i. by letter, sent by post to, or left at, the Parties' last known address or registered office and if sent by post, it will be deemed to have been served at the time it would, in the ordinary course of post, be delivered; or
 - ii. by fax or other electronic means to the Pledgor's last known fax number or electronic mail address and it will be deemed to have been served at the time of transmission by the Pledgor.

13. GOVERNING LAW AND JURISDICTION

- a. This Pledge shall be governed and construed in accordance with the laws of Malta.
- b. The Parties submit to the non-exclusive jurisdiction of the courts of Malta. The Parties waive any objection to the Maltese Courts on grounds of inconvenient forum or otherwise as regards proceedings in connection with this Pledge and agree that a judgement or order of such a Court shall be conclusive and binding on the Parties and may be enforced against the Parties in the Courts of any other jurisdiction.

14. TRANSFER OF RIGHTS

- a. The Pledgee may sell, assign or transfer its rights, benefits and obligations under this Pledge to anyone at any time.
- b. If the Pledgee sells, assigns or transfers any or all of its rights, benefits and obligations, the Pledgee's rights, benefits and obligations under this Pledge will stay exactly the same but the Pledgee will be bound to any person or organisation to whom the Pledgee sells, assigns or transfers. That person or organisation will have the Pledgor's powers and rights, benefits and obligations so far as these are sold, assigned or transferred.
- c. The Pledgee will be released automatically from its obligations to the Pledgor so far as the Pledgor's obligations are assumed by that person or organisation.
- d. In so far as the Pledgor is concerned, a reconstruction, conversion, amalgamation or division involving the Pledgee shall be dealt with in the same manner as an assignment or transfer.

15. SEVERANCE AND MODIFICATION – UNENFORCEABILITY

- a. If any of the clauses (or part of a clause) of this Pledge is or becomes invalid or unenforceable in any way under any law, the validity of the remaining clauses (or part of a clause) will not in any way be affected or impaired.
- b. If any invalid or unenforceable clause (or part of a clause) would not be invalid or unenforceable if its form or effect were modified in any way, it shall be deemed to have the modified form or effect so long as the Pledgee consents.

16. ENTIRE AGREEMENT

- a. This Pledge supersedes all prior negotiations, commitments, undertakings and writings pertaining to the subject matter of this Pledge and constitutes the entire understanding between the pledgor and the pledgee.

Mr Kurt Abela
For and on behalf of
the Guarantor

Mr Robert Geismann
For and on behalf of
the Pledgee

Ms Geraldine Schembri
For and on behalf of
the Pledgee

Mr Etienne Borg Cardona
For and on behalf of
the Pledgor

Mr John Soler
For and on Behalf of
the Pledgor

Mr Karl Micallef
For and on Behalf of
the Manager

Mr David Curmi
For and on Behalf of
the Manager

Annex C – Accountant’s Report

Annex C – Accountant's Report

The Directors
KA Finance Plc
Project Technik
Cannon Road
Qormi QRM 9032
Malta

24th July, 2019

Dear Sirs

Independent Accountants’ Report on the Forecast Financial Information of K.A. Finance plc

I report on the Forecast Consolidated Statements of Financial Position, Income Statement and Cash Flow (the “Forecast Financial Information”) of K.A. Finance plc (“the issuer”), and its parent (collectively “the Group”) for the financial years ending 31st December 2019, 31st December 2020, 31st December 2021, 31st December 2022 and 31st December 2023. The Forecast Financial Information, the basis of preparation and the material assumptions upon which the forecasts are based, are set out in the Annex D “Forecast Information of the Issuer” and Annex E “Summary of significant assumptions and accounting policies” of the Company Admission Document issued by K.A. Finance plc dated 24th July, 2019.

This report is required in terms of Appendix 4.7 (4) in the Prospects MTF Rules issued by the Malta Stock exchange dated July 2019 and is given for the purpose of complying with that regulation and no other purpose.

Directors’ responsibilities for the Forecast Financial Information

It is the responsibility of the Directors of the Issuer to prepare the Forecast Financial Information and the assumptions upon which it is based, as set out in Annex E “Summary of significant assumptions and accounting policies” of the Company Admission Document, in accordance with the requirements of the Prospects MTF Rules issued by the Malta Stock Exchange.

Accountants’ responsibility

It is my responsibility to form an opinion as required by Appendix 4.7 (4) in the Prospects MTF Rules as issued by the Malta Stock Exchange as to the proper compilation of the Forecast Financial Information. In so far as the application of the underlying accounting policies and accuracy of calculations are concerned, and to report that opinion to you.

Save for any responsibility which I may have to those persons to whom this report is expressly addressed, to the fullest extent permitted by law, I do not assume any responsibility and will not accept any liability to any other person for any loss suffered by any such person as a result of, arising out of, or in connection with the report or my statement, required by and given solely for the purposes of complying with the Prospects MTF Rules.

Basis of preparation of the Forecast Financial Information

The financial information has been prepared on the basis stated in "Summary of significant assumptions and accounting policies" in Annex E of the Company Admission Document and is based on the forecasts for the years ending 31st December 2019, 31st December 2020, 31st December 2021, 31st December 2022 and 31st December 2023. The Forecast Financial Information is required to be presented on a basis consistent with the accounting policies of the Group.

Basis of Opinion

I have examined the basis of compilation and the accounting policies of the accompanying Forecast Financial Information of the Group for the years ended 31st December 2019, 31st December 2020, 31st December 2021, 31st December 2022 and 31st December 2023 in accordance with ISAE 3000 "Assurance Engagements Other than Audits and Reviews of Historical Financial Information". My work included evaluating the basis on which the financial information included in the forecast has been prepared and considering whether the Forecast Financial Information has been accurately computed based upon the disclosed assumptions and the accounting policies of the Group.

The assumptions upon which the Forecast Financial Information is based are solely the responsibility of the Directors of K.A. Finance plc and accordingly I express no opinion on the validity of the assumptions. However, I considered whether anything came of my attention to indicate that any of the assumptions adopted by the Directors which, in my opinion, are necessary for a proper understanding of the Forecast Financial Information have not been disclosed and whether any material assumption made by the Directors appears to me to be unrealistic.

I planned and performed my work so as to obtain the information and explanations I considered necessary in order to provide me with reasonable assurance that the Forecast Financial Information has been properly compiled on the basis stated, in so far as the application of the underlying accounting policies and accuracy of calculations are concerned.

The Forecast Financial Information is not intended to, and does not provide all the information and disclosures necessary to give a true and fair view of the results of the operations and the financial position of the group in according with International Financial Reporting Standards as adopted by the EU (IFRSs).

Since the Forecast Financial Information and the assumptions on which it is based relate to the future and may therefore be affected by unforeseen events, I can express no opinion as to whether the actual results reported will correspond to those shown in the Forecast Financial Information and differences may be material.

Opinion

In my opinion, the Forecast Financial Information has been properly compiled on the basis stated and the basis of accounting used is consistent with the accounting policies of the Group.

Yours sincerely,

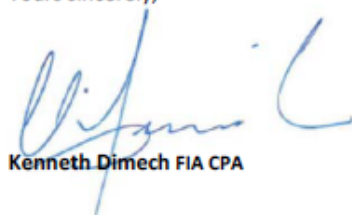

Kenneth Dimech FIA CPA

Annex D – Forecast Information of the Guarantor

Income statement

| | A 2017 | A 2018 | B 2019 | P 2020 | P 2021 | P 2022 | P 2023 |
|--|------------------|------------------|------------------|------------------|------------------|------------------|------------------|
| Revenue | | | | | | | |
| Centris 1 | 483,930 | 685,607 | 749,432 | 773,168 | 788,203 | 803,543 | 819,193 |
| Centris 2 | - | - | - | 237,884 | 922,054 | 927,837 | 945,981 |
| Swieqi | - | - | - | 394,408 | 484,858 | 509,391 | 535,167 |
| Gzira | - | - | - | 29,023 | 124,124 | 130,404 | 137,003 |
| Total revenue | 483,930 | 685,607 | 749,432 | 1,434,484 | 2,319,238 | 2,371,175 | 2,437,342 |
| Cost of sales | | | | | | | |
| Centris 1 | - | (24,000) | (24,480) | (24,970) | (25,469) | (25,978) | (26,498) |
| Centris 2 | - | - | - | (12,000) | (24,480) | (24,970) | (25,469) |
| Swieqi | - | - | - | (95,977) | (138,441) | (144,086) | (160,896) |
| Gzira | - | - | - | (10,820) | (45,012) | (46,813) | (48,685) |
| Total cost of sales | - | (24,000) | (24,480) | (143,767) | (233,403) | (241,847) | (261,548) |
| Gross profit | | | | | | | |
| Centris 1 | 483,930 | 661,607 | 724,952 | 748,199 | 762,734 | 777,564 | 792,695 |
| Centris 2 | - | - | - | 225,884 | 897,574 | 902,868 | 920,512 |
| Swieqi | - | - | - | 298,431 | 346,416 | 365,305 | 374,271 |
| Gzira | - | - | - | 18,203 | 79,111 | 83,591 | 88,317 |
| Total gross profit | 483,930 | 661,607 | 724,952 | 1,290,717 | 2,085,836 | 2,129,328 | 2,175,795 |
| Administrative expenses | | | | | | | |
| Centris 1 | (50,921) | (61,484) | (62,800) | (64,147) | (65,526) | (66,937) | (68,381) |
| Centris 2 | - | - | - | (46,629) | (94,989) | (84,760) | (86,572) |
| Swieqi | - | - | - | (42,272) | (86,536) | (88,575) | (90,665) |
| Gzira | - | - | - | (16,580) | (67,647) | (69,000) | (70,380) |
| Other costs (CA & trust) | - | - | (44,750) | (63,000) | (63,000) | (63,000) | (63,000) |
| Total Administrative expenses | (50,921) | (61,484) | (107,550) | (232,629) | (377,698) | (372,273) | (378,999) |
| Operating profit | 433,009 | 600,123 | 617,402 | 1,058,087 | 1,708,137 | 1,757,055 | 1,796,796 |
| Depreciation | - | - | - | (20,000) | (57,000) | (57,000) | (57,000) |
| PBIT | 433,009 | 600,123 | 617,402 | 1,038,087 | 1,651,137 | 1,700,055 | 1,739,796 |
| Interest | | | | | | | |
| Bank | (89,492) | (129,386) | (117,551) | (111,001) | (104,107) | (96,851) | (89,214) |
| Interest on Prospects MTF Bond | - | - | - | (148,500) | (297,000) | (297,000) | (297,000) |
| Total interest | (89,492) | (129,386) | (117,551) | (259,501) | (401,107) | (393,851) | (386,214) |
| Profit before tax | 343,517 | 470,737 | 499,851 | 778,587 | 1,250,031 | 1,306,205 | 1,353,582 |
| Tax | (66,268) | (90,505) | (103,719) | (179,579) | (290,636) | (301,970) | (309,977) |
| Net profit before Fair Value gain | 277,249 | 380,232 | 396,131 | 599,007 | 959,395 | 1,004,235 | 1,043,605 |
| Fair Value gain on IP | 2,258,060 | 1,071,115 | 5,172,827 | 4,401,500 | - | - | - |
| Deferred Tax on Fair Value gain | (264,000) | (96,000) | (1,340,416) | - | - | - | - |
| Total Net Profit | 2,271,309 | 1,355,347 | 4,228,542 | 5,000,507 | 959,395 | 1,004,235 | 1,043,605 |

A – Audited
B- Budgeted
P – Projected

Statement of financial position as at
31st December

| | A 2017 | A 2018 | P 2019 | P 2020 | P 2021 | P 2022 | P 2023 |
|--------------------------------------|-------------------|-------------------|-------------------|-------------------|-------------------|-------------------|-------------------|
| ASSETS | | | | | | | |
| Non-current assets | | | | | | | |
| Investment property | | | | | | | |
| Centris 1 | 10,800,000 | 12,000,000 | 12,000,000 | 12,000,000 | 12,000,000 | 12,000,000 | 12,000,000 |
| Centris 2 | - | - | 7,000,000 | 14,000,000 | 14,000,000 | 14,000,000 | 14,000,000 |
| Swieqi | - | 646,681 | 2,281,650 | 2,261,650 | 2,221,650 | 2,181,650 | 2,141,650 |
| Gzira | - | 212,942 | 473,550 | 473,550 | 456,550 | 439,550 | 422,550 |
| Total Investment property | 10,800,000 | 12,859,623 | 21,755,200 | 28,735,200 | 28,678,200 | 28,621,200 | 28,564,200 |
| Other | | | | | | | |
| Financial assets | 36,736 | 36,736 | 36,736 | 36,736 | 36,736 | 36,736 | 36,736 |
| Sinking fund | - | - | - | - | - | - | - |
| Total non-current assets | 10,836,736 | 12,896,359 | 21,791,936 | 28,771,936 | 28,714,936 | 28,657,936 | 28,600,936 |
| Current assets | | | | | | | |
| Trade and other receivables | 223,789 | 350,813 | 184,791 | 353,708 | 571,867 | 584,673 | 600,989 |
| Cash and cash equivalents | 42,282 | 12,362 | 2,849,037 | 404,180 | 1,295,175 | 2,073,356 | 2,880,095 |
| Total current assets | 266,071 | 363,175 | 3,033,828 | 757,888 | 1,867,041 | 2,658,030 | 3,481,084 |
| Total assets | 11,102,807 | 13,259,534 | 24,825,764 | 29,529,824 | 30,581,977 | 31,315,965 | 32,082,019 |
| EQUITY AND LIABILITIES | | | | | | | |
| Capital and reserves | | | | | | | |
| Share capital | 150,000 | 150,000 | 150,000 | 150,000 | 150,000 | 150,000 | 150,000 |
| Retained earnings | 280,486 | 660,719 | 1,056,850 | 1,655,858 | 2,615,253 | 3,619,488 | 4,663,092 |
| Revaluation reserve | 5,764,508 | 6,739,623 | 10,572,034 | 14,973,534 | 14,973,534 | 14,973,534 | 14,973,534 |
| Total equity | 6,194,994 | 7,550,342 | 11,778,884 | 16,779,392 | 17,738,787 | 18,743,022 | 19,786,626 |
| Non-current liabilities | | | | | | | |
| Interest-bearing borrowings | 1,914,123 | 1,855,722 | 1,982,985 | 1,844,775 | 1,699,310 | 1,546,208 | 1,385,068 |
| MTF prospects Bond | - | - | 6,102,750 | 6,114,750 | 6,126,750 | 6,138,750 | 6,150,750 |
| Shareholder's loans | - | - | - | - | - | - | - |
| Amounts due to related parties | - | 812,320 | 812,320 | 812,320 | 662,320 | 512,320 | 362,320 |
| Deferred taxation | 864,000 | 960,000 | 2,300,416 | 2,300,416 | 2,300,416 | 2,300,416 | 2,300,416 |
| Security Deposits received | 403,053 | 406,052 | 454,177 | 598,552 | 598,552 | 598,552 | 598,552 |
| Total non-current liabilities | 3,181,176 | 4,034,094 | 11,652,648 | 11,670,813 | 11,387,348 | 11,096,246 | 10,797,106 |
| Current liabilities | | | | | | | |
| Interest-bearing borrowings | 137,872 | 126,832 | 131,315 | 138,209 | 145,465 | 153,102 | 161,140 |
| Trade and other payables | 1,518,076 | 1,453,840 | 1,159,197 | 761,830 | 1,019,741 | 1,021,626 | 1,027,170 |
| Current taxation | 70,689 | 94,426 | 103,719 | 179,579 | 290,636 | 301,970 | 309,977 |
| Total current liabilities | 1,726,637 | 1,675,098 | 1,394,232 | 1,079,619 | 1,455,843 | 1,476,698 | 1,498,287 |
| Total liabilities | 4,907,813 | 5,709,192 | 13,046,879 | 12,750,432 | 12,843,191 | 12,572,944 | 12,295,393 |
| Total equity and liabilities | 11,102,807 | 13,259,534 | 24,825,764 | 29,529,824 | 30,581,977 | 31,315,965 | 32,082,019 |

A – Audited
B- Budgeted
P – Projected

Statement of cash flow

| | A | A | P | P | P | P | P |
|---|--------------------|------------------|--------------------|--------------------|------------------|------------------|------------------|
| | 2017 | 2018 | 2019 | 2020 | 2021 | 2022 | 2023 |
| | € | € | € | € | € | € | € |
| Cash flows from operating activities | | | | | | | |
| Total Net Profit | 2,271,309 | 1,355,347 | 4,228,542 | 5,000,507 | 959,395 | 1,004,235 | 1,043,605 |
| Adjustments Fair Value gain | (1,994,060) | (975,115) | (3,832,411) | (4,401,500) | - | - | - |
| Net income Before Fair Value gain | 277,249 | 380,232 | 396,131 | 599,007 | 959,395 | 1,004,235 | 1,043,605 |
| Interest | 89,492 | 129,386 | 117,551 | 259,501 | 401,107 | 393,851 | 386,214 |
| Tax | 66,268 | 90,505 | 103,719 | 179,579 | 290,636 | 301,970 | 309,977 |
| Operating profit | 433,009 | 600,123 | 617,402 | 1,038,087 | 1,651,137 | 1,700,055 | 1,739,796 |
| depreciation | - | - | - | 20,000 | 57,000 | 57,000 | 57,000 |
| Changes in working capital | | | | | | | |
| (Increase) decrease in receivables | (400,810) | (127,024) | 166,022 | (168,917) | (218,159) | (12,806) | (16,315) |
| (Increase) decrease inventory | - | - | - | - | - | - | - |
| Increase (decrease) payables | 241,690 | 751,083 | (246,518) | (252,992) | 107,911 | (148,115) | (144,456) |
| Interest Paid | (89,492) | (129,386) | (117,551) | (396,001) | (389,107) | (381,851) | (374,214) |
| Tax Paid | - | (66,768) | (94,426) | (103,719) | (179,579) | (290,636) | (301,970) |
| Cash from operating activities | 184,397 | 1,028,028 | 324,928 | 136,459 | 1,029,204 | 923,647 | 959,841 |
| Cash flows from investing activities | | | | | | | |
| Purchase of property plant and equipment | (1,010,822) | (988,507) | (3,500,000) | (2,450,000) | - | - | - |
| Purchase of financial assets | | | | | | | |
| (Payments to)/from Sinking fund | | | | | | | |
| Net cash from investing activities | (1,010,822) | (988,507) | (3,500,000) | (2,450,000) | - | - | - |
| Cash flows from financing activities | | | | | | | |
| Proceeds from loans | 892,371 | 43,489 | 256,511 | | | | |
| Payments of loans excluding interest | | (112,930) | (124,765) | (131,315) | (138,209) | (145,465) | (153,102) |
| Share capital | | | | | | | |
| Proceeds from MTF prospects | | | 5,880,000 | | | | |
| Payments of MTF prospects | | | | | | | |
| Net cash from financing activities | 892,371 | (69,441) | 6,011,746 | (131,315) | (138,209) | (145,465) | (153,102) |
| Net cash movement for the period | 65,946 | (29,920) | 2,836,674 | (2,444,856) | 890,994 | 778,182 | 806,739 |
| Opening cash balance | (23,664) | 42,282 | 12,362 | 2,849,037 | 404,180 | 1,295,175 | 2,073,356 |
| Closing cash balance | 42,282 | 12,362 | 2,849,037 | 404,180 | 1,295,175 | 2,073,356 | 2,880,095 |

A – Audited
 B- Budgeted
 P – Projected

Annex E - Summary of significant assumptions and accounting policies

Introduction

The forecast statement of financial position, the forecast income statement, and the forecast statement of cash flows ('the Forecasts') of the Group for the period of 5 years to December 2023 have been prepared to provide financial information for the purposes of inclusion in the Issuer's Company Admission Document, dated 24th July, 2019. The Forecasts as presented in Annex D of the Company Admission Document, together with the assumptions set out below, are the sole responsibility of the Directors of the Issuer.

The Forecasts are intended to show a possible outcome based on assumptions relating to anticipated future events which the Directors expect to take place, and on actions the Directors expect to take. Events and circumstances frequently do not occur as expected, and therefore, actual results may differ materially from those included in the forecast and projected financial information. Attention is drawn in particular, to the risk factors set out in the Admission Document, which describe the primary risks associated with the business to which the Forecasts relate.

The Forecasts are not intended to and do not provide all the information and disclosures necessary to give a true and fair view of the financial results, financial position, and cash flows of the Group, in accordance with International Financial Reporting Standards as adopted by the EU, however the Directors have exercised due care and diligence in adopting the assumptions set out below.

The Forecasts were formally approved 8th May 2019 by the Directors of the Issuer, and the stated assumptions reflect the judgements made by the Directors at that date. The assumptions that the Directors believe are significant to the prospective financial information are described below.

Significant accounting policies

The significant accounting policies of the Group are those applied in preparing financial statements in accordance with the International Financial Reporting Standards (IFRS) and their interpretations as adopted by the EU and in accordance with the requirements of the Companies Act, 1995. Where applicable, in so far as they relate to recognition and measurement criteria, these have been applied in the preparation of the forecast financial information.

Basis of preparation and principal assumptions

Since the Issuer has no trading record of operations, these projections have been prepared solely on managements assumptions, which have been summarised below.

The principal assumptions relating to the environment in which the Group will operate, and the factors which are exclusively outside the influence of the Directors and which underlie the forecast financial statements, are the following:

- Exchange rates will not fluctuate significantly over the period covered by the forecast financial information;
- Interest rates will not change significantly over the period covered by the forecast financial information;
- The Group will be able to meet its financial obligations;
- The basis and rates of taxation, direct and indirect, will not change materially throughout the period covered by the prospective financial information.

The principal assumptions relating to the environment in which the Group will operate, and the factors which the Directors can influence, and which underlie the Forecasts, are the following:

Key assumptions underlying the financial projections

- The bond proceeds will be utilised to provide interest-bearing loans to related parties who will in turn use the funds for financing and investment activities.
- The amount transferred to group company will be repaid out of operating cashflows as reflected in the financial sustainability forecast of the group.
- Annual revenue and direct costs have been projected on the basis of management's past experience as well as management's expectations of future growth.
- Administrative expenses have been forecast on the basis of management's experience.
- Finance costs have been forecast on the basis of existing arrangements, whereas interest on the Bond has been established at 4.75% per annum.
- Credit terms offered to clients and credit terms availed of from suppliers are in line with industry practice.

Conclusion

The Directors believe that the assumptions on which the projections are based are reasonable. The Directors further believe that, in the absence of unforeseen circumstances outside their control, the working capital available to the Group will be sufficient for the carrying on of its business.

Approved by the Board of Directors on the 24th July, 2019 and signed on its behalf by:

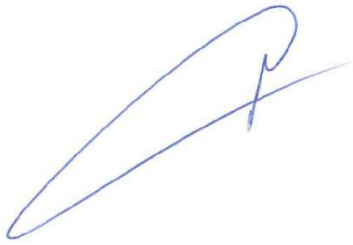

Kurt Abela



Etienne Borg Cardona

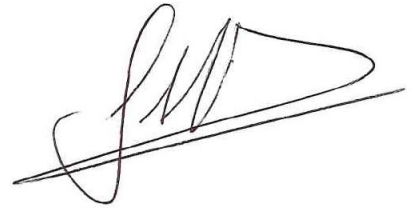

John Soler

Annex F- Application Form

KA Finance plc
€6,000,000 4.75% Secured Callable Bonds 2026 - 2029

APPLICATION FORM
Application No.

Please read the notes overleaf before completing this Application Form. Mark 'X' if applicable. Unless otherwise indicated, each of the panels below is to be completed.

| | | | |
|--|---|---|--|
| APPLICANT | | | |
| A | <input type="checkbox"/> Non-Resident | <input type="checkbox"/> Minor (Under 18) | <input type="checkbox"/> Corporate |
| | | | <input type="checkbox"/> CIS |
| B | TITLE (Mr/Mrs/Ms/...) | FULL NAME & SURNAME / REGISTERED NAME | |
| ADDRESS | | | POST CODE |
| MSE A/C NO. (if applicable) | | DATE OF BIRTH | NATIONALITY |
| ID CARD/ PASSPORT/ CO. REG. NO. LEGAL ENTITY IDENTIFIER (LEI) | | DOCUMENT NUMBER | COUNTRY OF ISSUANCE |
| E-MAIL ADDRESS | | TEL NO. | MOBILE NO. |
| Already Registered for e-Portfolio <input type="checkbox"/> | | Please register me for e-Portfolio <input type="checkbox"/> | Please do NOT register me for e-Portfolio <input type="checkbox"/> |
| C ADDITIONAL (JOINT) APPLICANTS (please use additional application form if space is not sufficient) | | | |
| | TITLE (Mr/Mrs/Ms/...) | FULL NAME & SURNAME | DATE OF BIRTH |
| | I.D. CARD / PASSPORT NO. | DOCUMENT NUMBER | COUNTRY OF ISSUANCE |
| | TITLE (Mr/Mrs/Ms/...) | FULL NAME & SURNAME | DATE OF BIRTH |
| | I.D. CARD / PASSPORT NO. | DOCUMENT NUMBER | COUNTRY OF ISSUANCE |
| D MINOR'S PARENTS/LEGAL GUARDIANS (See Note 4) (to be completed ONLY if the Applicant is a minor) | | | |
| | TITLE (Mr/Mrs/Ms/...) | FULL NAME & SURNAME | DATE OF BIRTH |
| | I.D. CARD / PASSPORT NO. | DOCUMENT NUMBER | COUNTRY OF ISSUANCE |
| | TITLE (Mr/Mrs/Ms/...) | FULL NAME & SURNAME | DATE OF BIRTH |
| | I.D. CARD / PASSPORT NO. | DOCUMENT NUMBER | COUNTRY OF ISSUANCE |
| E | I/We apply to purchase and acquire the amount set out below | | |
| | AMOUNT IN FIGURES € | AMOUNT IN WORDS | |
| KA Finance plc €6,000,000 Secured Callable 4.75% Bonds 2026-2029 at the Bond Issue Price (at par) pursuant to the Company Admission Document dated 24 th July 2019 (minimum €2,000 and in multiples of €100 thereafter) | | | |
| F RESIDENT - WITHHOLDING TAX DECLARATION (to be completed ONLY if the Applicant is a Resident of Malta) | | | |
| <input type="checkbox"/> I/We elect to have Final Withholding Tax deducted from my/our interest. | | | |
| <input type="checkbox"/> I/We elect to receive interest GROSS (i.e. without deduction of withholding tax). | | | |
| G NON-RESIDENT DECLARATION FOR TAX PURPOSES (to be completed ONLY if the Applicant is a Non-Resident) | | | |
| TAX COUNTRY | | TOWN OF BIRTH | |
| T.I.N. (Tax Identification Number) | | COUNTRY OF BIRTH | |
| PASSPORT/NATIONAL I.D. CARD NUMBER | | ISSUE DATE | |
| <input type="checkbox"/> I/We am/are NOT Resident in Malta but I/we am/are Resident in the European Union. | | | |
| <input type="checkbox"/> I/We am/are NOT Resident in Malta and I/we am/are NOT Resident in the European Union. | | | |
| H INTEREST, REFUND AND REDEMPTION MANDATE (completion of this panel is mandatory) | | | |
| BANK | | IBAN | |
| I/We have fully understood the instructions for completing this Application Form, and am/are making this Application on the basis of the Company Admission Document, and subject to its Terms and Conditions (as defined therein) which have been explained to me/us, and which I/we fully accept. | | | |
| Signature/s of Applicant/s (All parties are to sign in the case of a joint Application) | | Financial Intermediary | Date |
| FINANCIAL INTERMEDIARY'S STAMP | | FINANCIAL INTERMEDIARY'S CODE | |

Notes on how to complete this Application Form and other information

The following notes are to be read in conjunction with the Company Admission Document dated 24th July 2019.

1. This Application is governed by the Terms and Conditions of Application contained in the Company Admission Document. Capitalised terms not defined herein shall, unless the context otherwise requires, have the same meaning ascribed to them in the Company Admission Document.
2. The Application Form is to be completed in BLOCK LETTERS.
3. Applicants are to insert full personal details in Panel B. In the case of an application by more than one person (including spouses) full details of all individuals – including I.D. Card Numbers – must be given in Panels B and C but the person whose name appears in Panel B shall, for all intents and purposes, be deemed to be the registered holder of the Bonds (vide note 7 below). Upon submission of an Application Form, Bondholders who do not have an online e-portfolio account will be registered by the CSD for the online e-portfolio facility and will receive by mail at their registered address a handle code to activate the new e-portfolio login. The Bondholder's statement of holdings evidencing entitlement to Secured Bonds held in the register kept by the CSD and registration advices evidencing movements in such register will be available through the said e-portfolio facility on <https://eportfolio.borzamalta.com.mt/>. Those Bondholders who opt not to avail themselves of this facility should indicate such on the Application Form. Further detail on the e-portfolio is found on <https://eportfolio.borzamalta.com.mt/Help>.
4. Applications in the name and for the benefit of minors shall be allowed provided that they are signed by both parents or by the legal guardian/s and accompanied by a Public Registry birth certificate of the minor in whose name and for whose benefit the Application Form is submitted. The relative box in Panel A must also be marked appropriately. Any Bonds allocated pursuant to such an Application shall be registered in the name of the minor as Bondholder, with interest and redemption proceeds payable to the parents or legal guardian/s signing the Application Form until such time as the minor attains the age of eighteen (18) years, following which all interest and redemption proceeds shall be payable directly to the registered holder, provided that the Issuer has been duly notified in writing of the fact that the minor has attained the age of eighteen (18) years.
5. Applicants who are Non-Resident in Malta for tax purposes must indicate their passport number in Panel B and complete Panel G. The relative box in Panel A must also be marked appropriately.
6. In the case of a body corporate, the name of the entity exactly as registered, the registration number and the legal entity identifier are to be inserted in Panel B. Applications must be signed by duly authorised representatives indicating the capacity in which they are signing.
7. APPLICANTS WHO ALREADY HOLD SECURITIES ON THE MSE ARE TO INDICATE THEIR MSE ACCOUNT NUMBER IN PANEL B.
8. The amount applied for must be in multiples of €100 subject to a minimum application of €2,000. The Applicant must ensure that the relative Application Form is accompanied by payment of the full price of the amount of Bonds applied for. Payment of the amount, must be made in Euro in cleared funds to "Cummi & Partners Limited – Clients Account". In the event that the cheque accompanying the Application Form is not honoured on the first presentation the Issuer and the Registrar reserve the right to invalidate the relative Application.
9. Only Applicants who hold an official Maltese Identity Card or companies registered in Malta will be treated as resident in Malta. In such a case the Applicant may elect to have Final Withholding Tax, currently 15%, deducted from interest payments in which case such interest need not be declared in the Applicant's income tax return. The Applicant may elect to receive the interest gross (i.e. without deduction of Final Withholding Tax), but he/she will be obliged to declare interest so received on his/her tax return. Authorised entities applying in the name of a Prescribed Fund (having indicated their status in the appropriate box in Panel A) will have Final Withholding Tax, currently 10%, deducted from interest payments.
10. In terms of Section 22 of the Company Admission Document, unless the Issuer is otherwise instructed by a Bondholder, or if the Bondholder does not fall within the definition of 'recipient' in terms of article 41(c) of the Income Tax Act (Cap. 123 of the Laws of Malta), interest shall be paid to such a person net of final withholding tax (currently 15%) of the gross amount of interest, pursuant to Article 33 of the Tax Act (Cap. 123 of the Laws of Malta).
11. If any Application is not accepted, after the closure of the subscription lists or is accepted for fewer Bonds than those applied for, the monies of the balance of the amount paid but not allocated, as the case may be, will be returned by direct credit into the bank account as indicated in the application form. Interest or redemption proceeds will be credited to the account designated or as otherwise amended by the Bondholder/s during the term of the Bond.
12. European Council Directive 2003/48/EC on the taxation of savings income in the form of interest payments requires all payors established in the EU which pay interest to an individual resident in another EU Member State, to report the interest payment to the tax authorities of the Member State in which the payor is established. If the Applicant's permanent residential address is in an EU Member State or in another country to which the said Directive applies (called a "specified territory") then the interest paid will be reported.
13. Interest and redemption proceeds will be credited to the account indicated in Panel H or as otherwise amended by the Bondholder/s during the term of the Bond.
14. Completed Application Forms are to be delivered to the Placement Agent and Manager, Curmi & Partners Limited during normal office hours by not later than 12:00 noon on the 7th August 2019. Remittances by post are made at the risk of the Applicant and the Issuer disclaims all responsibility for any such remittances not being received by the closing date indicated above. The Issuer reserves the right to refuse any Application, which appears to be in breach of the general terms and conditions of the Admissions Document. Any applications received by the Placement Agent and Manager after 12:00 noon on the 7th August 2019 will be rejected.
15. By completing and delivering an Application Form you (as the Applicant(s)):
 - a. acknowledge that the Issuer may process the personal data that you provide in the Application Form in accordance with the GDPR and Data Protection Act (Cap. 586 of the Laws of Malta);
 - b. acknowledge that the Issuer may process such personal data for all purposes necessary for and related to the Bonds applied for; and
 - c. acknowledge that you, as the Applicant, have the right to request access to and rectification of the personal data relating to you, as processed by the Issuer. Any such requests must be made in writing and addressed to the Issuer. The request must be signed by yourself as the Applicant to whom the personal data relates.

The value of investments can go up or down and past performance is not necessarily indicative of future performance. The nominal value of the Bonds on offer will be repayable in full upon redemption. An investor should consult an independent financial advisor, licensed under the Investment Services Act (Cap. 370 of the Laws of Malta), for advice.

Annex G – List of Directorships

Etienne Borg Cardona

PRESENT

| | |
|--|---------|
| AIM PROFESSIONAL ACADEMY LTD | C 30777 |
| ALEXO INTERNATIONAL HOLDINGS LIMITED | C 69690 |
| APS FUNDS SICAV PLC | SV78 |
| ATLINGTON CAPITAL MANAGEMENT LIMITED | C 86591 |
| CALAMATTA CUSCHIERI FINANCE PLC | C 85280 |
| CAPITAL ADVISORY LIMITED | C 77470 |
| CAPITAL CONSULTING LIMITED | C 55426 |
| CYAN BLUE INTERNATIONAL LIMITED | C 80721 |
| CYAN BLUE INTERNATIONAL HOLDINGS LIMITED | C 80716 |
| DEBONO GROUP HOLDINGS COMPANY LIMITED | C 59559 |
| FALCON ENERGY LTD | C 54710 |
| FORESTALS INVESTMENTS LIMITED | C 58184 |
| FORTUNE TECHNOLOGIES LIMITED | C 27838 |
| GASAN FINANCE COMPANY PLC | C 16435 |
| ICT LTD | C46930 |
| J M VASSALLO VIBRO BLOCKS LTD | C1677 |
| KA FINANCE PLC | C 91544 |
| MAIN STREET COMPLEX PLC | C 34767 |
| MISTRAL HOLDINGS LIMITED | C 55455 |
| ORSUS INTERNATIONAL LIMITED | C 64803 |
| PHOENICIA FINANCE COMPANY PLC | C 88958 |
| STARMAC MALTA LIMITED | C 70626 |
| STRYKER MEDTECH LIMITED | OC 863 |
| TELEFLEX DEVELOPMENT UNLIMITED COMPANY | OC 1205 |
| TOGETHER GAMING SOLUTIONS PLC | C 72231 |
| VITASOY HOLDINGS (MALTA) LIMITED | C 42423 |

PAST

| | |
|--------------------------------------|---------|
| ACCESS POINT TECHNOLOGY LIMITED | C 34500 |
| AIRCRAFT ABS HOLDINGS MALTA LIMITED | C 72961 |
| CHINA DESIGNER OUTLET MALL P.L.C | C 78823 |
| DOCUMENTS ARCHIVE MANAGEMENT LIMITED | C 48631 |
| DAI MARKETING LIMITED | C 23636 |
| FETCHIT TECHNOLOGIES LIMITED | C 79744 |
| FGL COMMERCIAL SALES LIMITED | C 31199 |
| FGL ENTERTAINMENT LIMITED | C 41655 |
| FGL GROUP SERVICES LIMITED | C 31201 |

| | |
|---|---------|
| FGL INFORMATION TECHNOLOGY LIMITE | C 31198 |
| FGL SERVICES LIMITED | C 55391 |
| FLOORCARE (SERVICES) LIMITED | C 8427 |
| FM DISTRIBUTION LIMITED | C 31255 |
| FORESTALS APPLIANCES LIMITED | C 313 |
| FORUM OPERATIONS LIMITED | C 18184 |
| HANDI-ICASH.COM LIMITED | C 70142 |
| ICT SOFTWARE LIMITED | C 47406 |
| INFORMATION TECHNOLOGY SERVICES LIMITED | C 15179 |
| KELQUAN HOLDINGS LIMITED | OC 923 |
| LEAD SERVICE TECHNOLOGIES LIMITED | C 64386 |
| ME & Co. LTD | C 83861 |
| NOEHW LIMITED | C 57079 |
| ONLINE TRADING LIMITED | C 49126 |
| Q- RETAIL LIMITED | C 36851 |
| RENTATORE MALTA LIMITED | C 47422 |
| SACAL HOLDINGS LIMITED | OC 924 |

John Soler

PRESENT

| | |
|------------------------------|---------|
| FCM BANK LTD | C 50343 |
| KA FINANCE PLC | C 91544 |
| AX HOLDINGS LTD | C 3595 |
| VALLETTA CRUISE PORT PLC | C 26469 |
| ORION RETAIL INVESTMENTS LTD | C 80707 |
| ORION FINANCE PLC | C 80722 |

Kurt Abela

PRESENT

| | |
|---------------------------------------|---------|
| KA HOLDINGS LTD | C 56023 |
| PROJECT TECHNIK LIMITED | C 48668 |
| PROJECT TECHNIK BUILDING SUPPLIES LTD | C 56383 |
| DO-IT-YOURSELF OUTLETS PLUS LIMITED | C 56199 |
| SSPA CO LTD | C 64936 |
| KA FINANCE PLC | C 91544 |
| WILLY LEASING LTD | C 51611 |